

56 Sparta Avenue • Newton, New Jersey 07860  
 (973) 300-3000 Sales • (973) 300-3600 Fax  
 www.thorlabs.com

**THORLABS**

## CM2001 - April 18, 2017

Item # CM2001 was discontinued on XXX YY, ZZZZ. For informational purposes, this is a copy of the website content at that time and is valid only for the stated product.

### CERNA MICROSCOPE WITH SIX-CUBE EPI-ILLUMINATION AND TRANS-ILLUMINATION

- ▶ Equipped with Six-Cube Epi-Illuminator and Trans-Illumination Module
- ▶ Ready to Accept Objectives, Cameras, Filters, and Illumination Sources

**Modular and Configurable**

**CM2001**  
 Cerna Microscope  
 (Optical Table Not Included)



[Hide Overview](#)

#### OVERVIEW

##### Features

- Six-Cube Epi-Illuminator and Transmitted Illumination Module
  - Epi-Illuminator Accepts Broad-Spectrum DC Lamps or Lamps with Ø3 mm Liquid Light Guides
  - Transmitted Light Module Accepts Mounted LEDs for Visible and/or IR Light
- Large and Open Working Space Underneath the Objective
  - Ideal for Sample Apparatuses, Recording Chambers, and Micromanipulators
- Compatible with Thorlabs and Major Manufacturers' Objectives, Scientific Cameras, Fluorescence Filters, and Illumination Sources
- Modular Design Allows User to Tweak and Modify the Microscope's Optical Path



Click to Enlarge  
 Side View of Cerna CM2001  
 Microscope  
 (Optical Table Not Included)

The CM2001 Cerna Microscope provides a preconfigured optical path that is ideal for experiments requiring either epi-fluorescence, reflected light, or brightfield imaging. The epi-illuminator accepts up to six filter cubes, ideal for targeting spectrally separated fluorophores, and the brightfield illumination module includes Thorlabs' Visible Illumination Kit that can be used to illuminate thin samples with visible light.

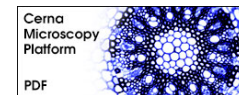

A dual-objective nosepiece, compatible with M25 x 0.75- and RMS-threaded objectives, lets you locate a region of interest using a low-magnification objective and then image using a high-magnification objective. Motorized objective and condenser focusing enables fine tuning of the epi- and trans-illumination conditions, and our six-cube epi-illuminator module is ideal for targeting spectrally separated fluorophores.

Unlike competing microscopes with similar capabilities, the Cerna platform's modularity lets the user quickly install and remove the microscope modules as needed for each experiment, providing a high degree of access and control. For example, when the trans-illumination modules are installed, *in vitro* samples can be studied using epi-fluorescence, as well as with basic widefield and brightfield illumination. To free room underneath the objective for large sample holding apparatuses, the brightfield module can be removed, providing a path for *in vivo* studies.

To address a wide range of experimental parameters, Thorlabs offers eight preconfigured Cerna microscopes, which are summarized in the table below. In addition, we can work with you to configure a microscope that meets your unique needs. To contact our team, please e-mail [ImagingSales@thorlabs.com](mailto:ImagingSales@thorlabs.com). We also offer Cerna components individually for customers interested in building their own microscope.

Cerna Microscopes	CM1001	CM1002	CM1003	CM2001	CM2002	CM3001	CM3002	CM3003(M)
Objective								

Holder	Single	Single	Single	Dual	Dual	Dual	Dual	Dual
Epi-Illumination	1 Cube	Up to 6 Cubes	1 Cube	Up to 6 Cubes	Up to 6 Cubes	Up to 6 Cubes	Up to 6 Cubes	Up to 6 Cubes
Trans-Illumination	-	-	Brightfield (Visible)	Brightfield (Visible)	Dot Contrast and Brightfield (Visible)	Dot Contrast and Brightfield (Visible and NIR)	DIC Imaging and Brightfield (Visible and NIR)	DIC Imaging and Brightfield (Visible and NIR)
XY Motion	-	-	-	-	-	Microscope Translator	-	Translating Platform

[Hide Microscope Design](#)

## MICROSCOPE DESIGN

### CM2001 Cerna Microscope

Entirely constructed from our line of modular components, this Cerna microscope includes several convenient features for imaging, which are highlighted below. We also offer a selection of microscope objectives, cameras, and illumination modules that can be used to complement your CM2001 Cerna microscope and customize it to your experiment. Details can be found on the *Accessories* tab. The *Shipping List* tab details the components used in this microscope, as well as a link to each component's webpage, where additional information (such as mechanical drawings) is available.

### Epi-Illumination

#### Features

- Six-Cube Epi-Illuminator Module (Filter Cubes and Sets Sold Separately)
- Compatible Light Sources
  - HPLS343 Lamp with Liquid Light Guide (Requires LLG3A5-A Adapter)
  - XCITE200DC Lamp with Liquid Light Guide
  - Other Illumination Sources with a Nikon Bayonet Mount

This microscope is able to target multiple fluorophores through the use of a six-cube epi-illuminator that couples light emitted by the illumination source into the imaging path, through the objective, and onto the sample; it also allows epi-fluorescence generated by the sample to pass through the module to the eyepieces and camera. A standard Nikon bayonet mount on the rear of the microscope accepts a wide range of white-light lamps. The intensity of illumination at the sample can be adjusted using the three neutral density (ND) filters mounted in black sliders at the back of the housing, as seen in the image to the lower left.



[Click to Enlarge](#)  
The CM2001 Cerna microscope features an epi-illuminator with a 6-cube filter turret. The filter position is labeled on the ring that rotates the turret. Three black sliders at the back of the housing contain neutral density filters.



[Click to Enlarge](#)  
The rotating turret accommodates up to six filter cubes (not included).



[Click to Enlarge](#)  
The back of the epi-illuminator has a bayonet mount for installing liquid light guides and LEDs.

#### Add-Ons: Epi-Illumination

- Illumination Sources
  - High-Power Light Source with Liquid Light Guide
  - X-Cite Lamps
- Epi-Fluorescence Filter Cubes
- Epi-Fluorescence Filter Sets



[Click to Enlarge](#)  
Transmitted Illumination Module with White Light LED

### Trans-Illumination (Brightfield Imaging)

#### Features

- Supports Brightfield Illumination in the Visible and/or NIR
- Accepts Thorlabs' Illumination Kits (Visible LED Kit Included)
- Motorized Condenser Focusing Module with 1" Travel
- 0.78 NA Nikon Condenser

This Cerna Microscope includes a module for brightfield imaging, designed to direct visible and/or IR illumination generated by one of our Illumination Kits into the optical path of the Cerna Microscope. Please see the full web presentation for additional information.

Bright illumination in the visible region of the spectrum is generated by the included illumination kit (Item # WFA1010), which uses one of Thorlabs' Mounted LEDs (Item # MWWHL3). The module features additional ports and a filter cube holder to allow for later expansion with IR or other wavelength LEDs. Please contact Technical Support with inquiries.

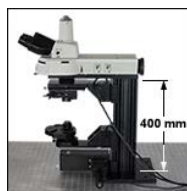

### Microscope Body

#### Features

- Large Working Volume: Optical Path is 7.74" (196.6 mm) Away from Edge of Rail
- Linear Dovetail Surface Allows Modules to be Added and Removed
- 400 mm Body Height to Accommodate Brightfield Illumination Module
- Motorized Objective Focusing Module with 1" Travel

Click to Enlarge  
The Cerna

CM2001 microscope has a 400 mm tall microscope body.

The backbone of the CM2001 Cerna Microscope is the 400 mm tall microscope body based on Thorlabs' 95 mm Optical Rails, providing stable long-term support and excellent vibrational damping. Its linear dovetail mounting surface allows modules to be removed when they are not needed, freeing additional workspace and opening the door to user customization. For alternate rail heights, please see the full web presentation.

Mechanically Compatible with Thorlabs' 95 mm Rail Platforms



Click to Enlarge  
This microscope includes trinoculars with a 1X camera port for widefield viewing.

## Widefield Viewing

### Features

- Fixed 1X Magnification Camera Port with C-Mount Accepts Most Industry-Standard Cameras
- Trinoculars with 10X Eyepiece Magnification and Adjustable Interpupil Distance

### Add-On: Widefield Viewing

- Scientific Cameras

Widefield viewing on the CM2001 Cerna Microscope is provided by trinoculars and a 1X Camera Tube. The eyepieces feature an adjustable interpupil distance and rotate individually to allow the focus to be coarsely adjusted for each eye. The total system magnification for an image viewed through the eyepieces will be the objective magnification multiplied by 10.

The included camera tube contains all of the optics needed to image the light from the objective onto a camera sensor. The tube has 1X magnification, which means that the image will match the design field of view of the chosen widefield objective. External C-mount (1.000-32") threads on the top of the camera tube accept Thorlabs' scientific cameras, as well as cameras from most major manufacturers. For additional viewing port and camera tube options, please see the full web presentation.

## Objective Holders and Objectives

### Features

- Use Low Magnification to Find the Region of Interest, then High Magnification to Image
- Compatible with M25 x 0.75-Threaded Objectives (Nikon)
- Compatible with RMS-Threaded Objectives (Olympus) by using an RMSA1 Thread Adapter

### Add-On: Objectives

- Microscope Objectives

The dual-objective nosepiece offers direct compatibility with M25 x 0.75-threaded objectives, and by adding an RMSA1 thread adapter (sold separately), compatibility with RMS-threaded objectives is enabled. Microscope objectives are available for purchase separately from Thorlabs, and we can also order other objectives from either Nikon or Olympus upon request. For other objective mounting options, please see the full web presentation.



Click to Enlarge  
The CM2001 Cerna Microscope features a dual objective changer. Adjusters on either side of the nosepiece provide fine parfocal adjustment.



Click to Enlarge  
10X and 40X objectives (not included) mounted in the CM2001 microscope's dual objective nosepiece. The 10X objective is currently positioned in the optical path.



Click to Enlarge  
The dual-objective nosepiece of the CM2001 microscope shown with a 40X high-power objective (not included) in the optical path.

[Hide Accessories](#)

## ACCESSORIES

### Selected Accessories

In order to image with this microscope, it is necessary to add scientific cameras, an epi-illumination source, filter cubes and filter sets, objectives, and sample holders. It is often possible to improve the quality of your experimental data by carefully selecting accessories that complement your specific experiment. To that end, we have ensured that Cerna microscopes are compatible with a wide range of accessories. The information below compares the Cerna-compatible components that are manufactured or sold by Thorlabs. We have also indicated when it is possible to use equipment designed by other manufacturers.

### Content

- Scientific Cameras for Widefield Viewing
- Illumination Sources for Epi-Illumination
- Filter Cubes and Filter Sets for Epi-Fluorescence
- Objectives
- Sample Holders

### Scientific Cameras for Widefield Viewing

- Visualize the Field of View at a Computer
- Any C-Mount Camera is Compatible with a Cerna Microscope

Thorlabs offers scientific cameras optimized for a range of imaging needs. Cameras allow the field of view to be displayed on a

### Application-Optimized Cerna Microscopes

Contact Us

Developed in collaboration with our colleagues in the field, the Cerna microscopy platform is uniquely modular and flexible, making it adaptable to a wide range of demanding experimental requirements. If you would like to work with our application specialists, engineers, and sales team to design your own microscopes, please email [ImagingSales@thorlabs.com](mailto:ImagingSales@thorlabs.com).



computer screen and saved for later reference. Viewing your sample from a computer also enables remote sample positioning using our motion control accessories (see below), allowing samples to be moved in sensitive setups without introducing additional vibrations from your hands.

Click to Enlarge  
The camera port provides fixed 1X magnification for visible light from the sample.

The CM2002 Cerna includes a 1X camera tube, which provides a fixed magnification at the image plane equal to the objective magnification.

Any camera with C-Mount (1.000"-32) threading is compatible with this microscope. The most popular cameras used with Cerna systems are given in the table below. Higher resolution options can be found in our complete range of scientific cameras.

Item #	DCU224M	340M-USB	1501M-USB
<b>Product Photo</b> (Click to Enlarge)			
<b>Primary Feature</b>	<b>Lightweight</b>	<b>Fast Frame Rate</b>	<b>High Resolution and Dynamic Range</b>
<b>Sensor Type</b>	Sony ICX205AL	On Semi / Truesense KAI-0340 Monochrome CCD	Sony ICX285AL Monochrome CCD (Grade 0)
<b>Sensor Format</b>	1/2" (7.62 mm Diagonal)	1/3" Format (5.92 mm Diagonal)	2/3" Format (11 mm Diagonal)
<b>Resolution</b>	1280 x 1024 Pixels	640 x 480 Pixels	1392 x 1040 Pixels
<b>Pixel Size</b>	4.65 μm x 4.65 μm	7.4 μm x 7.4 μm	6.45 μm x 6.45 μm
<b>Frame Rate (Max)</b>	15 fps	200.7 fps	23 fps
<b>Host PC Interface</b>	USB 2.0 (Cable Included)	USB 3.0 (Cable Included)	
<b>Digital Output</b>	8 Bits	14 Bits	14 Bits
<b>Mass</b>	96 g (0.21 lbs)	750 g (1.65 lbs)	

### Illumination Sources for Epi-Illumination

- White Light Sources Illuminate the Field of View Through the Objective
- Available Options Include Liquid Light Guide and Broad-Spectrum LED Lamps
- Light is Conditioned by Filter Cubes and Filter Sets for Specific Fluorophores (See Below)

The six-cube epi-illuminator module that is included with this Cerna microscope requires a broadband white light source that emits across the visible region of the spectrum. Broadband emission makes it possible for the same microscope to stimulate fluorophores that have absorption wavelengths that are spectrally separated. Several filter sets aimed at common fluorophores are available below.



Click to Enlarge  
A Bayonet-to-LLG Adapter is Being Attached to the Six-Cube Epi-Illuminator Module

All three lamps offered by Thorlabs provide emission throughout the visible range, local intensity control from the front panel of the light source, and external intensity control via BNC and/or USB 2.0. They are equipped with a flexible liquid light guide (LLG) that makes it easy to position the lamp around the rest of your equipment.

Any illumination source that can be coupled to a Nikon bayonet mount is compatible with Cerna microscopes. For example, Thorlabs' LLG3A5-A adapter connects any Ø3 mm LLG to a Nikon bayonet mount. We also manufacture lamphouse port adapters that make Nikon bayonet mounts compatible with our Ø1" or Ø2" lens tubes.



Click to Enlarge

#### HPLS343 Features

- ▶ Output Spectrum: 350 - 800 nm



Click to Enlarge

#### XCITE200DC Features

- ▶ Output Spectrum: 340 - 800 nm

- ▶ Intensity is Variable from 0.1% to 100% Using Knob
- ▶ External Control via USB 2.0 or BNC Inputs
- ▶ Lifetime: 10,000 Hours (Average)
- ▶ Includes Ø3 mm, 1.2 m (4') Long LLG
- ▶ Requires LLG3A5-A Collimating Adapter (Sold Separately)
- ▶ Link to Full Web Presentation

- ▶ Intensity is Variable from 0% to 100% Using Knob
- ▶ External Control via BNC Input
- ▶ Lifetime: >2,000 Hours Minimum; >2,500 Hours Typical
- ▶ Includes Ø3 mm, 5' (1.5 m) Long LLG and Nikon Bayonet Mount
- ▶ Link to Full Web Presentation

## Filter Cubes and Filter Sets for Epi-Fluorescence

- Tune Epi-Illumination Source for the Excitation and Detection of Specific Fluorophores
- Up to Six Filter Cubes can be Installed Simultaneously
- Select Filter Sets Available Pre-Installed in Microscope Filter Cubes
- Cerna Microscopes are Compatible with Fluorescence Filters from All Major Manufacturers
- Other Filter Sets Available



Click to Enlarge  
TLV-TE2000 Filter Cube  
Accepts: Excitation Filter (Ø25 mm, up to 5 mm Thick), Emission Filter (Ø25 mm, up to 3.5 mm Thick), and Dichroic Mirror (up to 25.2 mm x 36.0 mm x 1.1 mm)

The epi-illumination module included with this microscope can hold up to six filter cubes at once, allowing the setup to target multiple fluorophores. A hand-operated turret is used to switch between the filter cubes, each of which holds a filter set that conditions the light emitted by the illumination source for a specific fluorophore, such as BFP, GFP, mCherry, or tdTomato.

The filter sets we offer, which consist of an excitation filter, an emission filter, and a dichroic mirror, come in the industry-standard sizes. For excitation and emission filters, the standard dimensions are Ø25 mm, while for dichroic mirrors, the standard dimensions are 25 mm x 36 mm. This allows Cerna microscopes to be compatible with filters from all major manufacturers.

The table to the right lists the filter sets we offer, as well as the fluorophores they target. If the filter cubes and filter sets are purchased at the same time, we will mount the filter sets in the filter cubes at no additional charge. Please contact Technical Support prior to purchase to take advantage of this service.

Filter Transmission Spectra <sup>a</sup>		
Item #	Target Fluorophore	Transmission Graph (Click for Plot)
MDF-BFP	BFP (Blue Fluorescent Protein)	
MDF-GFP2	Alexa Fluor <sup>®</sup> 488	
MDF-MCHA <sup>b</sup>	mCherry	
MDF-MCHC <sup>c</sup>	mCherry	
MDF-TOM	tdTomato	

- a. Please see the full web presentation for a complete listing of fluorescence filter sets offered.
- b. This filter set's excitation range is centered around 578 nm, making it well matched to typical LEDs.
- c. This filter set's excitation range is centered around 562 nm, making it well matched to typical lamps.

## Objectives

- Directly Accepts M25 x 0.75-Threaded Objectives (Nikon)
- Nikon Objectives Support DIC; Matching DIC Optics are Included (Polarizers, Prisms, and Analyzer)
- Compatible with RMS-Threaded Objectives (Olympus) using an RMSA1 Adapter

The nosepiece of this microscope contains M25 x 0.75 threads in two places, allowing it to hold two objectives simultaneously. M25 x 0.75 threads are typically used by Nikon objectives. For convenience, we stock several widefield Nikon objectives that are commonly used with Cerna microscopes, shown in the table below. Our in-stock selection is not exhaustive. If you would like to order a different objective from either Nikon or Olympus, please contact us.

To use RMS-threaded objectives with this microscope, an RMSA1 thread adapter is needed. These adapters effectively convert the RMS threads to M25 x 0.75 threads, as shown in the photo to the right. RMS threads are most commonly used by Olympus objectives.



Click to Enlarge  
The RMSA1 Thread Adapter (not included) Converts RMS Threads to M25 x 0.75 Threads

Item #	N4X-PF	N10X-PF	N20X-PF	N40X-PF	N60X-PF
Photo (Click to Enlarge)					
Magnification	4X	10X	20X	40X	60X
Numerical Aperture (NA)	0.13	0.3	0.50	0.75	0.85
Working Distance (WD)	17.2 mm	16 mm	2.1 mm	0.66 mm	0.31 - 0.4 mm
Threading	M25 x 0.75				

## Sample Holders

- Rigid Stands Hold Samples Underneath and Around the Objective
  - Designed for Slides, Petri Dishes, Well Plates, Recording Chambers, Micromanipulators, and Custom Inserts
  - Translation Stages with 1" of X and Y Travel Available



Click to Enlarge  
MP100-MLSH Rigid Stand with MLS203P2 Slide/Petri Dish Holder



Click to Enlarge  
MLS203-1 Stage with MLS203P2 Slide Holder on CSA1000 Fixed Arm



Click for Details  
MP100-RCH2 Slide Holder in a

- Fixed Arms Incorporate Fast XY Stage, Lens Tubes, and/or Cage Systems to be Placed Directly into Optical Path
  - CSA1000: For Our MLS203-1 Fast XY Scanning Stage
  - CSA1001: For Ø1" Lens Tubes and 30 mm Cage Systems
  - CSA1002: For Ø2" Lens Tubes and 60 mm Cage Systems

Thorlabs offers highly configurable solutions for mounting your sample beneath the objective of the Cerna microscope. Rigid stands are available with multiple platform styles that can accept slides, petri dishes, recording chambers, micromanipulators, and custom inserts. The included collar makes them lockable at a height and angle chosen by the user. We also manufacture translation stages for these rigid stands that provide motorized horizontal translation of the sample.

Our fixed arms attach directly to the dovetail that spans the height of the microscope body, allowing them to be positioned anywhere along the body height, putting the sample directly into the microscope's optical path, and taking advantage of the existing footprint of the scope. For a pre-configured sample holder solution, use the CSA1000 Fixed Arm with the MLS203-1 Fast XY Scanning Stage. This stage is compatible with our MZS500-E Piezo-Driven Insert, which adds high-resolution Z-axis adjustments. Alternatively, the CSA1001 and CSA1002 Fixed Arms are compatible with Thorlabs' extensive selection of optomechanical components, allowing custom sample holder configurations to be integrated with the microscope body.

Several compatible options are outlined in the tables below. For our full range of rigid stand inserts and heights, please see their full web presentation.

Rigid Stands



[Click to Enlarge](#)

**MP150-RCH2 Slide Holder**

- ▶ Designed for Standard 3" x 1" (76.2 mm x 25.4 mm) Microscope Slides
- ▶ Height Range: 198.1 - 309.3 mm
- ▶ Other Heights Available



[Click to Enlarge](#)

**MP150-MLSH Insert Holder**

- ▶ Designed for Multiple Slides, Petri Dishes, Well Plates, Calibration Targets, Breadboards, Our MZS500-E Z-Axis Piezo Stage, and User-Designed Inserts
- ▶ Height Range: 198.1 - 309.3 mm
- ▶ Other Heights Available



[Click to Enlarge](#)

**MP150-RCH1 Recording Chamber Holder**

- ▶ Circular Hole Designed for Recording Chambers
- ▶ Height Range: 198.1 - 309.3 mm
- ▶ Other Heights Available



[Click to Enlarge](#)

**MP150 Rigid Stand with Platform**

- ▶ 24 M6 x 1.0 Tapped Holes for Holding Micromanipulators or Other Equipment
- ▶ Height Range: 198.1 - 309.3 mm
- ▶ Other Heights Available

Fixed Arms



[Click to Enlarge](#)

**CSA1000 Fixed Arm**

- ▶ Accepts MLS203-1 Fast XY Scanning Stage



[Click to Enlarge](#)

**CSA1001 Fixed Arm**

- ▶ Compatible with Ø1" Lens Tubes and 30 mm Cage Systems



[Click to Enlarge](#)

**CSA1002 Fixed Arm**

- ▶ Compatible with Ø2" Lens Tubes and 60 mm Cage Systems

[Hide Shipping List](#)

SHIPPING LIST

The microscope on this webpage is entirely constructed from our selection of modular Cerna components. This tab lists all of the components that the microscope contains.

Item #	Qty.	Description	Photo (Click to Enlarge)
<b>Microscope Body</b>			
CEA1400	1	Cerna Microscope Body with Epi-Illumination Arm, 400 mm Tall	

			
<b>Widefield Viewing</b>			
WFA4000	1	Trinoculars with Eyepieces	
WFA4105	1	1X Camera Tube with C-Mount	
<b>Epi-Illumination</b>			
CSE1000	1	Epi-Illuminator Module for Six Filter Cubes (Filter Cubes Not Included)	
<b>Condenser</b>			
CSC1001	1	Nikon FN-C LWD Condenser, 0.78 NA	
<b>Objective &amp; Condenser Mounting</b>			
CSN1202	1	Dual-Objective Nosepiece	
CSA1200	1	Mounting Arm for CSN1202 Nosepiece	
CSA2000	1	Condenser Mounting Arm with $\pm 2$ mm Travel in X and Y	
ZFM2020	2	Motorized Focusing Module with 1" Travel	
MCM3001	1	3-Axis Controller for Focus Control	
<b>Trans-Illumination</b>			
WFA1000	1	Brightfield Illumination / DIC Imaging Module	
WFA0150	1	Transmitted Light Module Dovetail Clamp	
<b>Illumination Kit</b>			
WFA1010	1	Visible Illumination Kit	
LEDD1B	1	T-Cube LED Driver, 1200 mA Max Drive Current (Power Supply Not Included)	
KPS101	1	15 V Power Supply Unit for a Single K-Cube or T-Cube	

[Hide Hyperspectral Imaging](#)

## HYPERSPECTRAL IMAGING

### Application Idea: Hyperspectral Imaging

In hyperspectral imaging, a stack of spectrally separated, two-dimensional images is acquired. This technique is frequently used in microscopy, biomedical imaging, and machine vision, as it allows quick sample

identification and analysis.

Hyperspectral imaging obtains images with significantly better spectral resolution than that provided by standalone color cameras. Color cameras represent the entire spectral range of an image by using three relatively wide spectral channels—red, green, and blue. In contrast, hyperspectral imaging systems incorporate optical elements such as liquid crystal tunable bandpass filters or diffraction gratings, which create spectral channels with significantly narrower bandwidths.

Thorlabs' Cerna microscopy platform, Kurios™ tunable filters, and scientific-grade cameras are easily adapted to hyperspectral imaging. The Cerna platform is a modular microscopy system that integrates with Thorlabs' SM lens tube construction systems and supports transmitted light illumination. Kurios tunable filters have SM-threaded interfaces for connections to the Cerna platform and our cameras. In addition, Kurios filters include software and a benchtop controller with external triggers, which enable fast, automated, synchronized wavelength switching and image capture.

### Example Image Stack

The data in the images and video below demonstrate the hyperspectral imaging technique. Figure 1 depicts two images of a mature *capsella bursa-pastoris* embryo (also known as shepherd's-purse) taken with a Kurios filter set to center wavelengths of 500 nm and 650 nm. These two images show that an entire field of view is acquired at each spectral channel. Figure 2 is a video containing 31 images of the same sample, taken at center wavelengths from 420 nm to 730 nm in 10 nm steps. (10 nm is not the spectral resolution; the spectral resolution is set by the FWHM bandwidth at each wavelength.) In Figure 3, images from each spectral channel are used to determine the color of each pixel and assemble a color image. Figure 3 also demonstrates that a broadband spectrum is acquired at each pixel, permitting spectroscopic identification of different sample features within the field of view.

Kurios tunable filters offer a number of advantages for hyperspectral imaging. Unlike approaches that rely upon angle-tunable filters or manual filter swapping, Kurios filters use no moving parts, enabling vibrationless wavelength switching on millisecond timescales. Because the filter is not moved or exchanged during the measurement, the data is not subject to "pixel shift" image registration issues. Our filters also include software and a benchtop controller with external triggers, making them easy to integrate with data acquisition and analysis programs.

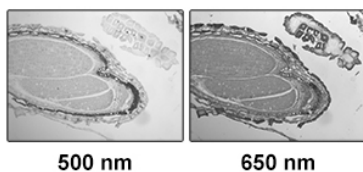

Click to Enlarge  
**Figure 1:** Two images of a mature *capsella bursa-pastoris* embryo taken at different center wavelengths. The entire field of view is acquired for each spectral channel.

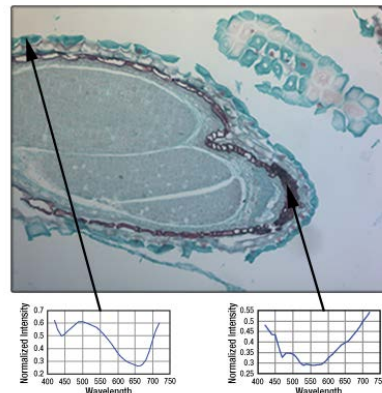

Click to Enlarge  
**Figure 3:** A color image of the mature *capsella bursa-pastoris* embryo, assembled using the entire field of view acquired in each spectral channel, as shown in Figure 1. By acquiring across multiple channels, a spectrum for each pixel in the image is obtained.

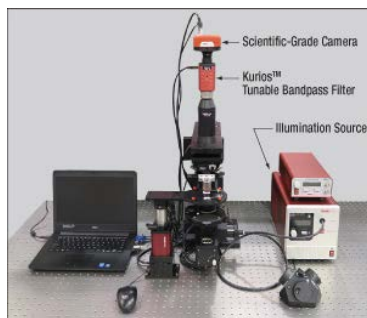

Click to Enlarge  
 A hyperspectral imaging system built using Thorlabs' Cerna Microscopy Platform, KURIOS-VB1 Tunable Bandpass Filter, and 1501M-GE Monochrome Scientific Camera. Several components shown here were modified from their stock configuration.

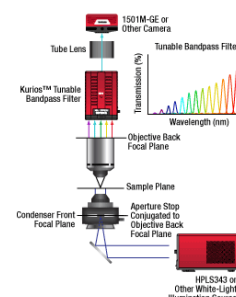

Click to Enlarge  
 Schematic of Hyperspectral Imaging

[Hide Microscope Guide](#)

## MICROSCOPE GUIDE

### Elements of a Microscope

This overview was developed to provide a general understanding of a Cerna microscope. Click on the different portions of the microscope graphic to the right or use the links below to learn how a Cerna microscope visualizes a sample.

- Terminology
- Microscope Body
- Illumination
- Sample Viewing/Recording

Click on the different parts of the microscope to explore their functions.



- Sample/Experiment Mounting

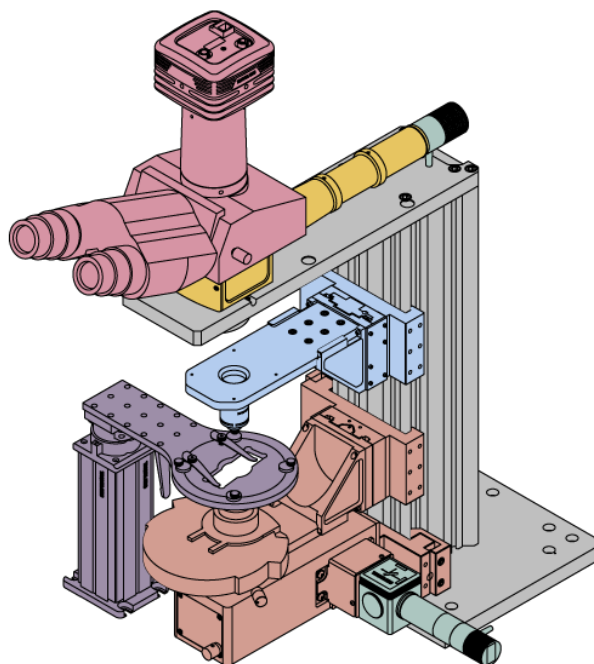

## Terminology

**Arm:** Holds components in the optical path of the microscope.

**Bayonet Mount:** A form of mechanical attachment with tabs on the male end that fit into L-shaped slots on the female end.

**Bellows:** A tube with accordion-shaped rubber sides for a flexible, light-tight extension between the microscope body and the objective.

**Breadboard:** A flat structure with regularly spaced tapped holes for DIY construction.

**Dovetail:** A form of mechanical attachment for many microscopy components. A linear dovetail allows flexible positioning along one dimension before being locked down, while a circular dovetail secures the component in one position. See the *Microscope Dovetails* tab or [here](#) for details.

**Epi-Illumination:** Illumination on the same side of the sample as the viewing apparatus. Epi-fluorescence, reflected light, and confocal microscopy are some examples of imaging modalities that utilize epi-illumination.

**Filter Cube:** A cube that holds filters and other optical elements at the correct orientations for microscopy. For example, filter cubes are essential for fluorescence microscopy and reflected light microscopy.

**Köhler Illumination:** A method of illumination that utilizes various optical elements to defocus and flatten the intensity of light across the field of view in the sample plane. A condenser and light collimator are necessary for this technique.

**Nosepiece:** A type of arm used to hold the microscope objective in the optical path of the microscope.

**Optical Path:** The path light follows through the microscope.

**Rail Height:** The height of the support rail of the microscope body.

**Throat Depth:** The distance from the vertical portion of the optical path to the edge of the support rail of the microscope body. The size of the throat depth, along with the working height, determine the working space available for microscopy.

**Trans-Illumination:** Illumination on the opposite side of the sample as the viewing apparatus. Brightfield, differential interference contrast (DIC), Dotd gradient contrast, and darkfield microscopy are some examples of imaging modalities that utilize trans-illumination.

**Working Height:** The height of the support rail of the microscope body plus the height of the base. The size of the working height, along with the throat depth, determine the working space available for microscopy.

## Microscope Body

The microscope body provides the foundation of any Cerna microscope. The support rail utilizes 95 mm rails machined to a high angular tolerance to ensure an aligned optical path and perpendicularity with the optical table. The support rail height chosen (350 - 600 mm) determines the vertical range available for experiments and microscopy components. The 7.74" throat depth, or distance from the optical path to the support rail, provides a large working space for experiments. Components attach to the body by way of either a linear dovetail on the support rail, or a circular dovetail on the epi-illumination arm (on certain models). Please see the *Microscope Dovetails* tab or [here](#) for further details.

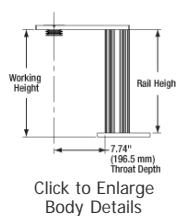

Click to Enlarge  
Body Details

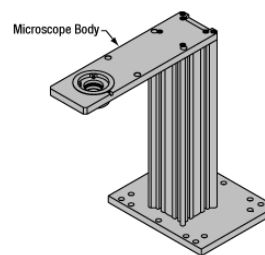

Enlarge  
Cerna Microscope Body

Click to

	
Microscope Bodies	Microscope Translator

### Illumination

Using the Cerna microscope body, a sample can be illuminated in two directions: from above (epi-illumination, see yellow components to the right) or from below (trans-illumination, see orange components to the right).

Epi-illumination illuminates on the same side of the sample as the viewing apparatus; therefore, the light from the illumination source (green) and the light from the sample plane share a portion of the optical path. It is used in fluorescence, confocal, and reflected light microscopy. Epi-illumination modules, which direct and condition light along the optical path, are attached to the epi-illumination arm of the microscope body via a circular D1N dovetail (see the *Microscope Dovetails* tab or here for details). Multiple epi-illumination modules are available, as well as breadboard tops, which have regularly spaced tapped holes for custom designs.

Trans-illumination illuminates from the opposite side of the sample as the viewing apparatus. Example imaging modalities include brightfield, differential interference contrast (DIC), Doldt gradient contrast, oblique, and darkfield microscopy. Trans-illumination modules, which condition light (on certain models) and direct it along the optical path, are attached to the support rail of the microscope body via a linear dovetail (see *Microscope Dovetails* tab or here). Please note that certain imaging modalities will require additional optics to alter the properties of the beam; these optics may be easily incorporated in the optical path via lens tubes and cage systems. In addition, Thorlabs offers condensers, which reshape input collimated light to help create optimal Köhler illumination. These attach to a mounting arm, which holds the condenser at the throat depth, or the distance from the optical path to the support rail. The arm attaches to a focusing module, used for aligning the condenser with respect to the sample and trans-illumination module.

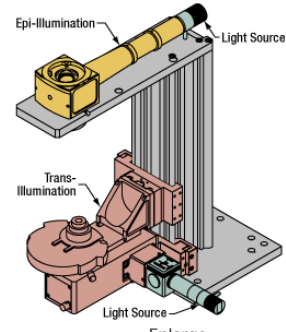

Click to Enlarge  
Illumination with a Cerna microscope can come from above (yellow) or below (orange). Illumination sources (green) attach to either.

							
Epi-Illumination Modules	Breadboards & Body Attachments	Brightfield	DIC	Doldt	Condensers	Condenser Mounting	Light Sources

### Sample Viewing/Recording

Once illuminated, examining a sample with a microscope requires both focusing on the sample plane (see blue components to the right) and visualizing the resulting image (see pink components).

A microscope objective collects and magnifies light from the sample plane for imaging. On the Cerna microscope, the objective is threaded onto a nosepiece, which holds the objective at the throat depth, or the distance from the optical path to the support rail of the microscope body. This nosepiece is secured to a motorized focusing module, used for focusing the objective as well as for moving it out of the way for sample handling. To ensure a light-tight path from the objective, the microscope body comes with a bellows (not pictured).

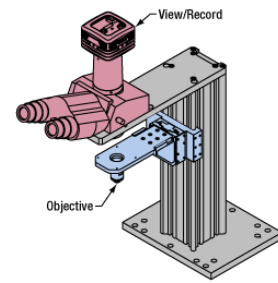

Click to Enlarge  
Light from the sample plane is collected through an objective (blue) and viewed using trinocs or other optical ports (pink).

Various modules are available for sample viewing and data collection. Trinoculars have three points of vision to view the sample directly as well as with a camera. Double camera ports redirect or split the optical path among two viewing channels. Camera tubes increase or decrease the image magnification. For data collection,

Thorlabs offers both cameras and photomultiplier tubes (PMTs), the latter being necessary to detect fluorescence signals for confocal microscopy. Breadboard tops provide functionality for custom-designed data collection setups. Modules are attached to the microscope body via a circular dovetail (see the *Microscope Dovetails* tab or here for details).

					
Objectives & Accessories	Objective Mounting	Sample Viewing	Cameras	PMTs	Breadboards & Body Attachments

### Sample/Experiment Mounting

Various sample and equipment mounting options are available to take advantage of the large working space of this microscope system. Large samples and ancillary equipment can be mounted via mounting platforms, which fit around the microscope body and utilize a breadboard design with regularly spaced tapped through holes. Small samples can be mounted on rigid stands (for example, see the purple component to the right), which have holders for different methods of sample preparation and data collection, such as slides, well plates, and petri dishes. For more traditional sample mounting, slides can also be mounted directly onto the microscope body via a manual XY stage. The rigid stands can translate by way of motorized stages (sold separately), while the mounting platforms contain built-in mechanics for motorized or manual translation. Rigid stands can also be mounted on top of the mounting platforms for independent and synchronized movement of multiple instruments, if you are interested in performing experiments simultaneously during microscopy.

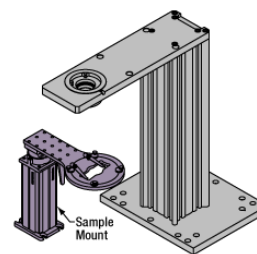

Click to Enlarge  
The rigid stand (purple) pictured is one of various sample mounting options available.

Close

				
Translating Platforms	Rigid Stands	Translation Stages for Rigid Stands	Motorized XY Stages	Manual XY Stage

For sample viewing, Thorlabs offers trinoculars, double camera ports, and camera tubes. Light from the sample plane can be collected via cameras, photomultiplier tubes (PMTs), or custom setups using breadboard tops. Click here for additional information about viewing samples with a Cerna microscope.

Product Families & Web Presentations



Close

Microscope objectives are held in the optical path of the microscope via a nosepiece. Click here for additional information about viewing a sample with a Cerna microscope.

Product Families & Web Presentations

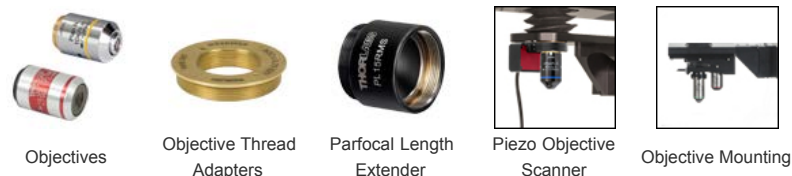

Close

Large and small experiment mounting options are available to take advantage of the large working space of this microscope. Click here for additional information about mounting a sample for microscopy.

Product Families & Web Presentations



Close

Thorlabs offers various light sources for epi- and trans-illumination. Please see the full web presentation of each to determine its functionality within the Cerna microscopy platform.

Product Families & Web Presentations



Trans-Illumination Kits   Solis™ High-Power LEDs   Mounted LEDs   X-Cite® Lamps   Other Light Sources

Close

Epi-illumination illuminates the sample on the same side as the viewing apparatus. Example imaging modalities include fluorescence, confocal, and reflected light microscopy. Click here for additional information on epi-illumination with Cerna.

Product Families & Web Presentations



Epi-Illumination   Body Attachments   Light Sources

Close

Trans-illumination illuminates from the opposite side of the sample as the viewing apparatus. Example imaging modalities include brightfield, differential interference contrast (DIC), Dodt gradient contrast, oblique, and darkfield microscopy. Click here for additional information on trans-illumination with Cerna.

Product Families & Web Presentations



Brightfield   DIC   Dodt   Condensers   Condenser Mounting   Illumination Kits   Other Light Sources

Close

The microscope body provides the foundation of any Cerna microscope. The 7.74" throat depth provides a large working space for experiments. Click here for additional information about the Cerna microscope body.

Product Families & Web Presentations



Microscope Bodies   Microscope Translator

[Hide Preconfigured Cerna Microscope](#)

**Preconfigured Cerna Microscope**

The CM2001 Cerna Microscope includes all components shown in the *Shipping List* tab.

Part Number	Description	Price	Availability
CM2001	Cerna Microscope with Six-Cube Epi- and Trans-Illumination	\$22,879.41	Lead Time

[Hide Cerna Microscope Components for Customized Configurations](#)

**Cerna Microscope Components for Customized Configurations**

To tailor the CM2001 Cerna microscope to your imaging needs, its components can be added all at once to the shopping cart using the "Add Kit" button at the bottom of the ordering area, or individually using the shopping cart icon next to each item. Items may be removed from the default item list by changing the value in

the "Qty" box to 0 before clicking the "Add Kit" button. This allows our modular microscope components to be used to adapt the microscope to the needs of the particular experiment. A discount is offered when a sufficient number of components are purchased, as reflected in the price of the CM2001. Please see the *Shipping List* tab for additional information about each component in the CM2001 microscope.

Part Number	Description	Price	Availability
CEA1400	Cerna Microscope Body with Epi-Illumination Arm, 400 mm Rail	\$837.00	Today
WFA4000	Trinoculars with 10X Eyepieces, Inverted Image, IR Filter	\$2,915.00	Today
WFA4105	1X Camera Tube with C-Mount, Male D2N Dovetail	\$395.00	Today
CSE1000	Epi-Illuminator Module for Up to 6 Filter Cubes, Male & Female D1N Dovetails	\$2,833.00	Today
CSC1001	Nikon FN-C LWD Condenser, 0.78 NA, Male D3N Dovetail	\$1,987.00	Today
CSN1202	Nosepiece for 2 Objectives, M25 x 0.75 Threads	\$1,832.00	Today
CSA1200	Mounting Arm for CSN1201 and CSN1202 Nosepieces	\$199.00	Today
CSA2000	Condenser Arm, $\pm 2$ mm Travel in X & Y, Female D3N Dovetail, 60 mm Cage Compatible	\$692.00	Today
ZFM2020	Motorized Module with 1" Travel for Edge-Mounted Arms	\$1,726.00	Lead Time
MCM3001	Three-Channel Controller and Knob Box for 1" Cerna Travel Stages	\$3,113.00	3-5 Days
WFA1000	Transmitted Light Illumination / DIC Imaging Module, 30 mm Cage Compatible	\$4,150.00	Today
WFA0150	95 mm Dovetail Clamp for WFA1000 and WFA1100 Modules	\$265.00	Today
WFA1010	Warm White Illumination Kit	\$789.00	Today
LEDD1B	T-Cube LED Driver, 1200 mA Max Drive Current (Power Supply Not Included)	\$299.00	Today
KPS101	15 V, 2.4 A Power Supply Unit for One K-Cube or T-Cube	\$26.25	Today

Visit the *Cerna Microscope with Six-Cube Epi-Illumination and Trans-Illumination* page for pricing and availability information:

[https://www.thorlabs.com/newgrouppage9.cfm?objectgroup\\_id=8890](https://www.thorlabs.com/newgrouppage9.cfm?objectgroup_id=8890)