

















Table of Contents

Chapter 1	Warning Symbol Definitions	1
Chapter 2	Description.....	2
Chapter 3	Setup.....	3
Chapter 4	Operation.....	8
	4.1. <i>Theory of Operation</i>	8
	4.2. <i>Responsivity</i>	8
	4.3. <i>Dark Current</i>	8
	4.4. <i>Bandwidth and Response</i>	9
	4.5. <i>Terminating Resistance</i>	9
	4.6. <i>Gain Adjustment</i>	9
Chapter 5	Troubleshooting	10
Chapter 6	Specifications	11
	6.1. <i>Response Curve</i>	12
	6.2. <i>Mechanical Drawing</i>	13
Chapter 7	Regulatory	14
Chapter 8	Thorlabs Worldwide Contacts.....	15

Chapter 1 Warning Symbol Definitions

Below is a list of warning symbols you may encounter in this manual or on your device.

Symbol	Description
	Direct Current
	Alternating Current
	Both Direct and Alternating Current
	Earth Ground Terminal
	Protective Conductor Terminal
	Frame or chassis Terminal
	Equipotentiality
	On (Supply)
	Off (Supply)
	In Position of a Bi-Stable Push Control
	Out Position of a Bi-Stable Push Control
	Caution, Risk of Electric Shock
	Caution, Hot Surface
	Caution, Risk of Danger
	Warning, Laser Radiation
	Caution: ESD Sensitive Components

Chapter 2 Description

The PDAPC4 is an amplified, switchable-gain, Indium Gallium Arsenide (InGaAs) photodetector in an OEM package with an operating wavelength range of 800 to 1700 nm. A DIP switch allows the user to vary the gain in 10 dB steps. A buffered output drives 50 Ω load impedances up to 5 V. The output signal is readable from the MMCX connector. We provide MMCX to BNC cables (Item # CA3339) or MMCX to SMA cables (Item # CA3439). Users can also access the digital pins of the gain switch or the output through an on-board header.



ESD Caution



This product is ESD sensitive. Take all appropriate precautions to discharge personnel and equipment before making any electrical connections to the unit.

Chapter 3 Setup

- The pin out table for the on-board header (J2), Figure 1, is shown in the two tables below:

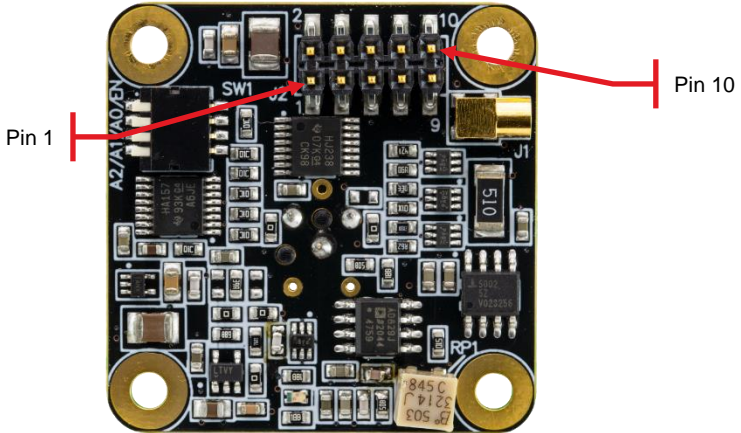

Figure 1 J2 Header

J2 PIN OUT			
Pin	Designation	Pin	Designation
1	+V	2	GND
3	GND	4	OUTPUT
5	-V	6	N.C.
7	A2	8	A1
9	A0	10	N.C.

Note:
Pins 1 & 5: ±V refers to the power supply positive/negative voltages.
Pins 7, 8, & 9: A0-A2 refers to the three digital pins for the gain adjustment.

Gain Switch Table			
A2	A1	A0	Gain
0	0	0	0 dB
0	0	1	10 dB
0	1	0	20 dB
0	1	1	30 dB
1	0	0	40 dB
1	0	1	50 dB
1	1	0	60 dB
1	1	1	70 dB

- 2. Connect a power supply to pins 1, 3, and 5 of the J2 header. The required power supply voltages are:

J2 Pin	Voltage
1	+12 VDC
3	GND
5	-12 VDC

Thorlabs offers the LD1255-SUPPLY as one compatible power supply option. Connection to the board is shown below:

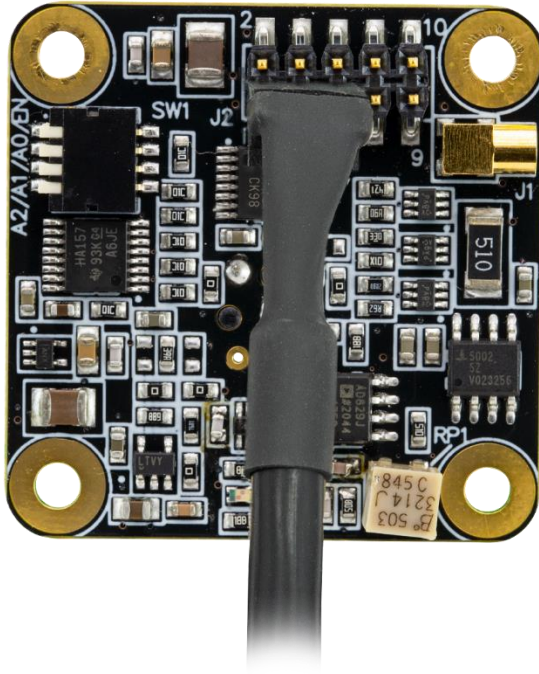

Figure 2 Power Supply Connection

- 3. Digital gain can be adjusted through the J2 header shown in Figure 1 or using the on-board DIP switch shown below. Each switch is 'Off'/0 when in the up position and 'On'/1 when in the down position.

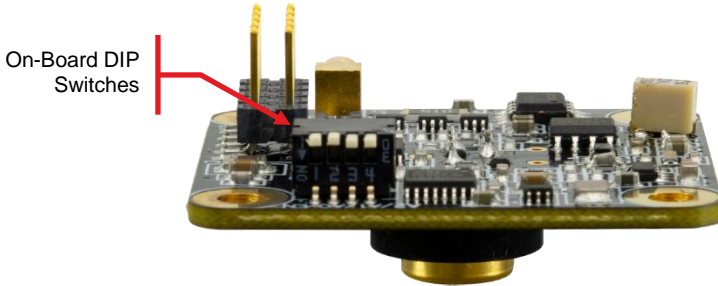

Figure 3 Location of the On-Board DIP Switches

The following table describes what each switch does:

Switch Number	Function
1	Enable
2	A0
3	A1
4	A2

To enable the DIP switch settings, set switch # 1 to 'On'/1. See the table on page 3 for the corresponding gain settings.

Note: The default DIP switch settings are all in the 'Off'/0 position and customer could only use J2 Header for gain setting purposes. When the DIP switch is enabled, it would override the settings of the J2 Header.

- The side adjusted potentiometer is used to adjust the voltage output's offset at high gain settings (e.g. 70 dB). This part is factory pre-adjusted so normally the user does not need to adjust it. However, if the output offset value has fallen out of spec, for example drift over time or temperature, then it is possible to adjust it back by turning this potentiometer. Turning the screw head clockwise decreases the offset voltage and adjusting the screw head counterclockwise increases it.

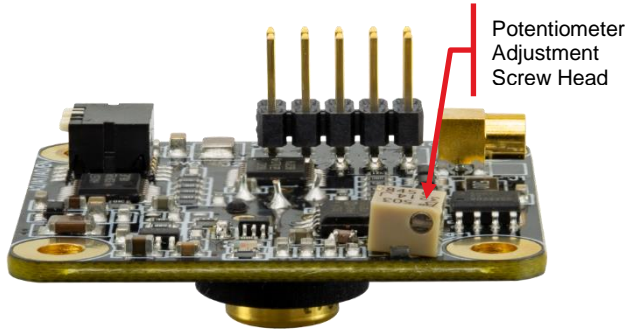
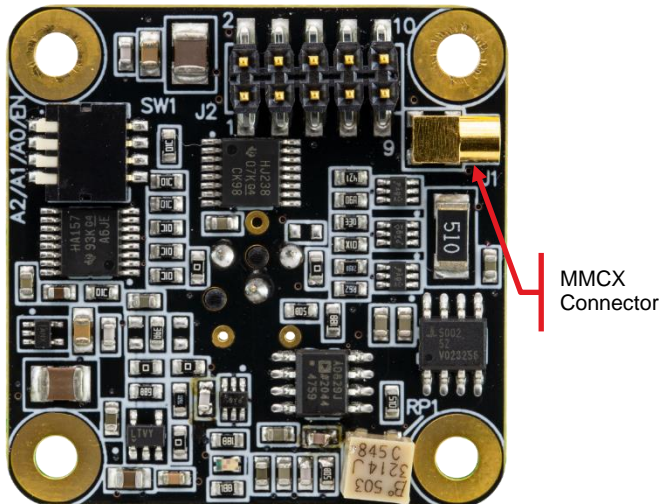

Figure 4 Side adjusted potentiometer

- Attach a 50 Ω coax cable to the output of the PDAPC4 detector. Thorlabs offers two suitable cable options, the CA3339 MMCX to BNC cable or the CA3439 MMCX to SMA cable.



When running cable lengths longer than 12", Thorlabs recommends terminating the opposite end of the coax with a 50 Ω resistor for optimal performance. Thorlabs Item # T4119 is suitable for this purpose.

Connect the remaining end to a measurement device such as an oscilloscope or high-speed DAQ card.

Caution

Many high speed oscilloscopes have input impedances of 50 Ω . In this case, do not install a 50 Ω terminator. The combined loads will equal 25 Ω which could allow ~135 mA of output current. This will damage the output driver of the PDA.

6. Power the PDAPC4 on. When the unit is on, the power indicator LED will be illuminated yellow. If the LED is green or red, this indicates only one power rail, either positive or negative, respectively, is connected. In that case, the user would need to check the power inputs to make sure both power rails are on and connected correctly.
7. Apply a light source to the detector, then adjust the gain controls to the desired setting.
8. During alignment, the user should take appropriate precautions. For example, ensuring the incident power is within safe operating power. Additionally, the user should have proper eye and skin protection as recommended by the light source manufacturer.

Chapter 4 Operation

4.1. Theory of Operation

Thorlabs PDA series are ideal for measuring both pulsed and CW light sources. The PDAPC4 includes a reverse-biased PIN photodiode, mated to a switchable gain transimpedance amplifier, and packaged in a rugged housing.

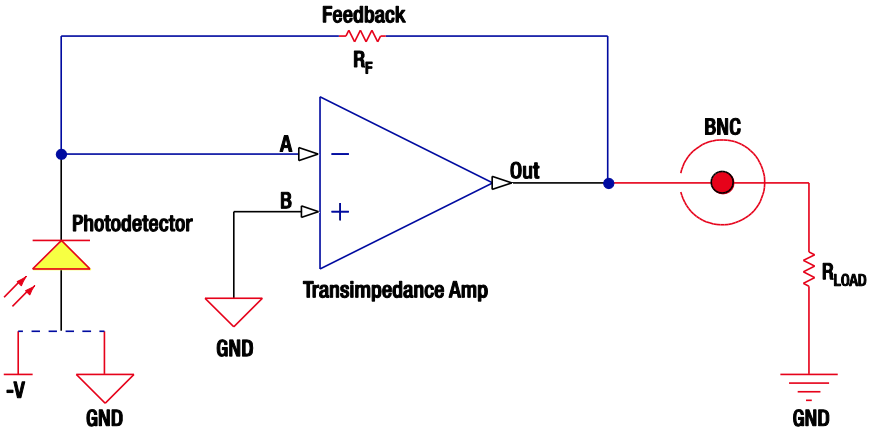

4.2. Responsivity

The responsivity of a photodiode can be defined as a ratio of generated photocurrent (I_{PD}) to the incident light power (P) at a given wavelength:

$$R(\lambda) = \frac{I_{PD}}{P}$$

4.3. Dark Current

Dark current is leakage current which flows when a bias voltage is applied to a photodiode. The PDA with Transimpedance Amplifier does control the dark current flowing out. Looking at the figure above, it can be noted that Point B is held at ground and the amplifier will try to hold point A to “Virtual Ground”. This minimizes the effects of dark current present in the system.

The dark current present is also affected by the photodiode material and the size of the active area. Silicon devices generally produce low dark current compared to germanium devices which have high dark currents. The table below lists several photodiode materials and their relative dark currents, speeds, sensitivity, and costs. Please note that sensitivity values in the table are typical values; Thorlabs offers photodetectors with sensitivity ranges that vary from those shown below.

Material	Dark Current	Speed	Sensitivity ¹	Cost
Silicon (Si)	Low	High	400 - 1000 nm	Low
Germanium (Ge)	High	Low	900 - 1600 nm	Low
Gallium Phosphide (GaP)	Low	High	150 - 550 nm	Med
Indium Gallium Arsenide (InGaAs)	Low	High	800 - 1800 nm	Med
Extended Range: Indium Gallium Arsenide (InGaAs)	High	High	1200 - 2600 nm	High

4.4. Bandwidth and Response

For the PDA detectors, the gain of the detector is dependent on the feedback element (R_f). The bandwidth of the detector can be calculated using the following:

$$f(-3dB) = \sqrt{\frac{GBP}{4\pi R_f \times C_D}}$$

Where GBP is the amplifier gain bandwidth product and C_D is the sum of the photodiode junction capacitance and the amplifier capacitance.

4.5. Terminating Resistance

The maximum output of the PDAPC4 is 10 V for high impedance loads (i.e. $R_{Load} > 5 \text{ k}\Omega$) and 5 V for 50 Ω loads. Adjust the gain so that the measured signal level out of the PDAPC4 is below 10 V (5 V with a 50 Ω load) to avoid saturation.

For low terminating resistors, $< 5 \text{ k}\Omega$ or 1% error, an additional factor needs to be considered. The output of the PDA includes a 50 Ω series resistor (R_s). The output load creates a voltage divider with the 50 Ω series resistor as follows:

$$Scale\ Factor = \frac{R_{Load}}{R_{Load} + R_s}$$

$$V_{OUT} = \mathcal{R}(\lambda) * Transimpedance\ Gain * Scale\ Factor * Input\ Power\ (W)$$

Note that we already include the scale factor in our specification for the gain at 50 Ω . Refer to the table in Chapter 6 for additional performance specifications.

4.6. Gain Adjustment

The PDAPC4 includes a low noise, low offset, high gain transimpedance amplifier that allows gain adjustment over a 70 dB range. The gain is adjusted by selecting the correct gain switch settings (see page 3). There are 8 gain positions incremented in 10 dB steps. It is important to note that the bandwidth will decrease as the gain increases. See the specifications table on page 11 to choose the best gain versus bandwidth for a given input signal.

¹ Approximate values; actual wavelength values will vary.

Chapter 5 Troubleshooting

Problem	Suggested Solutions
There is no signal response.	Verify that the power is switched on and all connections are secure.
	Verify the proper terminating resistor is installed if using a Voltage measurement device.
	Verify that the optical signal wavelength is within the specified wavelength range.
	Verify that the optical signal is illuminating the detector active area.
Output Voltage will not increase. Detector Output is skewed.	Check to make sure the detector is not saturated. Refer to the Output Voltage specification in the table on page 11.

Chapter 6 Specifications

All performance specifications are typical, performed at 25 °C ambient temperature, and assume a 50 Ω load, unless stated otherwise.

Performance Specifications ²			
0 dB Setting		40 dB Setting	
Gain (Hi-Z)	1.51×10^3 V/A $\pm 2\%$	Gain (Hi-Z)	1.51×10^5 V/A $\pm 2\%$
Gain (50 Ω)	0.75×10^3 V/A $\pm 2\%$	Gain (50 Ω)	0.75×10^5 V/A $\pm 2\%$
Bandwidth	11 MHz	Bandwidth	90 kHz
Noise (RMS)	286 μV	Noise (RMS)	240 μV
NEP (@ λ _p)	6.1×10^{-11} W/√Hz	NEP (@ λ _p)	1.95×10^{-12} W/√Hz
Offset	±8 mV (Typ.) ±12 mV (Max)	Offset	±8 mV (Typ.) ±12 mV (Max)
10 dB Setting		50 dB Setting	
Gain (Hi-Z)	4.75×10^3 V/A $\pm 2\%$	Gain (Hi-Z)	4.75×10^5 V/A $\pm 2\%$
Gain (50 Ω)	2.38×10^3 V/A $\pm 2\%$	Gain (50 Ω)	2.38×10^5 V/A $\pm 2\%$
Bandwidth	1.5 MHz	Bandwidth	28 kHz
Noise (RMS)	201 μV	Noise (RMS)	260 μV
NEP (@ λ _p)	5.7×10^{-12} W/√Hz	NEP (@ λ _p)	2.24×10^{-12} W/√Hz
Offset	±8 mV (Typ.) ±12 mV (Max)	Offset	±8 mV (Typ.) ±12 mV (Max)
20 dB Setting		60 dB Setting	
Gain (Hi-Z)	1.5×10^4 V/A $\pm 2\%$	Gain (Hi-Z)	1.5×10^6 V/A $\pm 5\%$
Gain (50 Ω)	0.75×10^4 V/A $\pm 2\%$	Gain (50 Ω)	0.75×10^6 V/A $\pm 5\%$
Bandwidth	1 MHz	Bandwidth	9 kHz
Noise (RMS)	236 μV	Noise (RMS)	300 μV
NEP (@ λ _p)	2.93×10^{-12} W/√Hz	NEP (@ λ _p)	2.25×10^{-12} W/√Hz
Offset	±8 mV (Typ.) ±12 mV (Max)	Offset:	±8 mV (Typ.) ±12 mV (Max)
30 dB Setting		70 dB Setting	
Gain (Hi-Z)	4.75×10^4 V/A $\pm 2\%$	Gain (Hi-Z)	4.75×10^6 V/A $\pm 5\%$
Gain (50 Ω)	2.38×10^4 V/A $\pm 2\%$	Gain (50 Ω)	2.38×10^6 V/A $\pm 5\%$
Bandwidth	260 kHz	Bandwidth	3 kHz
Noise (RMS)	234 μV	Noise (RMS)	396 μV
NEP (@ λ _p)	2.19×10^{-12} W/√Hz	NEP (@ λ _p)	2.28×10^{-12} W/√Hz
Offset	±8 mV (Typ.) ±12 mV (Max)	Offset	±8 mV (Typ.) ±12 mV (Max)

² The PDAPC4 has a 50 Ω series terminator resistor (i.e. in series with amplifier output). This forms a voltage divider with any load impedance (e.g. 50 Ω load divides signal in half).

Electrical Specifications		
Detector	-	InGaAs
Active Area	-	Ø2.0 mm (3.14 mm ²)
Wavelength Range	λ	800 to 1700 nm
Peak Wavelength	λ_p	1590 nm (Typ.)
Peak Response	$\mathcal{R}(\lambda_p)$	1.04 A/W (Typ.)
Amplifier GBP	-	600 MHz
Output Impedance	-	50 Ω
Max Output Current	I_{OUT}	100 mA
Load Impedance	-	50 Ω to Hi-Z
Gain Adjustment Range	-	0 dB to 70 dB
Gain Steps	-	8 x 10 dB Steps
Output Voltage	V_{OUT}	0 to 5 V (50 Ω) 0 to 10 V (Hi-Z)

General	
PCB Size	1.47" x 1.47" (37.34 mm x 37.34 mm)
Operating Temperature	10 to 40 °C
Storage Temperature	-20 to 70 °C

6.1. Response Curve

PDAPC4 Responsivity

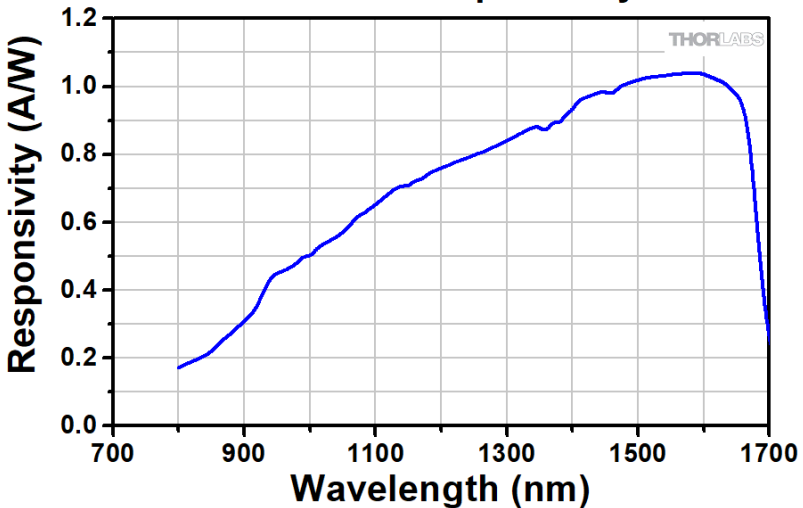

6.2. Mechanical Drawing

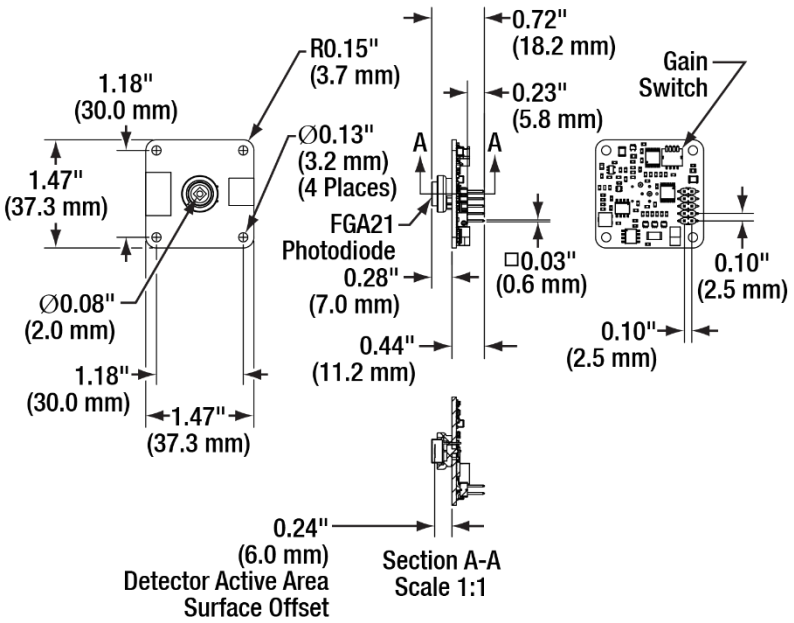

Chapter 7 Regulatory

As required by the WEEE (Waste Electrical and Electronic Equipment Directive) of the European Community and the corresponding national laws, Thorlabs offers all end users in the EC the possibility to return “end of life” units without incurring disposal charges.

- This offer is valid for Thorlabs electrical and electronic equipment:
- Sold after August 13, 2005
- Marked correspondingly with the crossed out “wheelie bin” logo (see right)
- Sold to a company or institute within the EC
- Currently owned by a company or institute within the EC
- Still complete, not disassembled and not contaminated

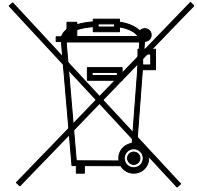

As the WEEE directive applies to self contained operational electrical and electronic products, this end of life take back service does not refer to other Thorlabs products, such as:

- Pure OEM products, that means assemblies to be built into a unit by the user (e.g. OEM laser driver cards)
- Components
- Mechanics and optics
- Left over parts of units disassembled by the user (PCB's, housings etc.).

If you wish to return a Thorlabs unit for waste recovery, please contact Thorlabs or your nearest dealer for further information.

Waste Treatment is Your Own Responsibility

If you do not return an “end of life” unit to Thorlabs, you must hand it to a company specialized in waste recovery. Do not dispose of the unit in a litter bin or at a public waste disposal site.

Ecological Background

It is well known that WEEE pollutes the environment by releasing toxic products during decomposition. The aim of the European RoHS directive is to reduce the content of toxic substances in electronic products in the future.

The intent of the WEEE directive is to enforce the recycling of WEEE. A controlled recycling of end of life products will thereby avoid negative impacts on the environment.

Chapter 8 Thorlabs Worldwide Contacts

For technical support or sales inquiries, please visit us at www.thorlabs.com/contact for our most up-to-date contact information.



USA, Canada, and South America

Thorlabs, Inc.
sales@thorlabs.com
techsupport@thorlabs.com

Europe

Thorlabs GmbH
europe@thorlabs.com

France

Thorlabs SAS
sales.fr@thorlabs.com

Japan

Thorlabs Japan, Inc.
sales@thorlabs.jp

UK and Ireland

Thorlabs Ltd.
sales.uk@thorlabs.com
techsupport.uk@thorlabs.com

Scandinavia

Thorlabs Sweden AB
scandinavia@thorlabs.com

Brazil

Thorlabs Vendas de Fotônicos Ltda.
brasil@thorlabs.com

China

Thorlabs China
chinasales@thorlabs.com



THORLABS

www.thorlabs.com
