

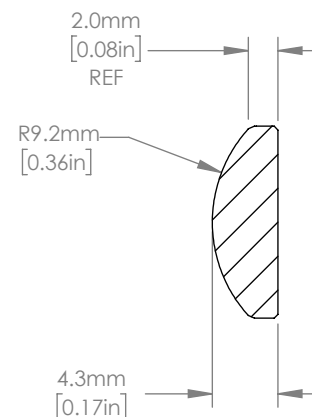

ISOMETRIC VIEW  
SCALE: 2:1

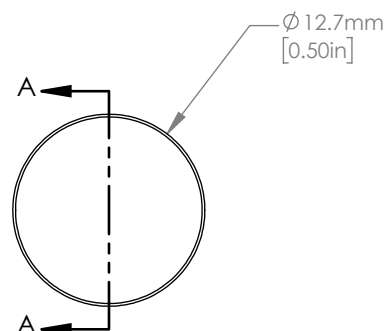

SECTION A-A

NOTES/SPECIFICATIONS:

1. DESIGN WAVELENGTH: 587.6 nm
2. FOCAL LENGTH:  $f=20.1\text{ mm} \pm 1\%$
3. BACK FOCAL LENGTH(REF):  $bf=17.1\text{ mm}$
4. CLEAR APERTURE:  $> \varnothing 11.43\text{ mm}$
5. SURFACE QUALITY: 20-10 SCRATCH-DIG
6. CENTRATION:  $< 3\text{arcmin}$
7. DIAMETER TOLERANCE:  $+0.0/-0.1\text{ mm}$
8. THICKNESS TOLERANCE:  $\pm 0.1\text{ mm}$
9. COATING: VAR R<0.25% PER SURFACE FOR 633 nm

FOR INFORMATION ONLY  
NOT FOR MANUFACTURING PURPOSES

DRAWING PROJECTION			<b>THORLABS</b> www.thorlabs.com	
NAME	DATE	$\varnothing 12.7\text{ mm } f=20\text{ mm}$ FUSED SILICA PLANO CONVEX LENS, -633 nm COAT		
DRAWN	YB	26/NOV/19	MATERIAL	REV
APPROVAL	ST	11/DEC/19	UV FUSED SILICA	A
COPYRIGHT © 2019 BY THORLABS			ITEM #	APPROX WEIGHT
VALUES IN PARENTHESIS ARE CALCULATED AND MAY CONTAIN ROUND OFF ERRORS			LA4647-633	0.87 g