

NOTES:

1. SUBSTRATE MATERIAL:  
FLOAT GLASS
2. COATING (APPLW ACROSS CLEAR APERTURE):  
S1: BARE ALUMINUM  
S2: NONE
3. BLAZE ANGLE: 13° 00'  
NOMINAL BLAZE WAVELENGTH: 500nm  
EFFICIENCY: 60-80% @ BLAZE WAVELENGTH

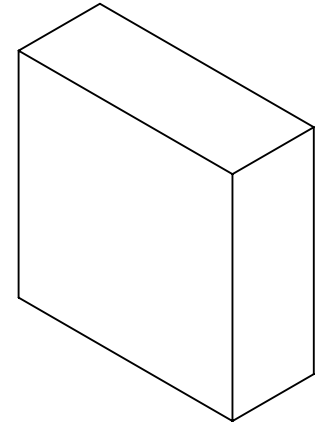

4. EDGES GROUND
5. RoHS COMPLIANT

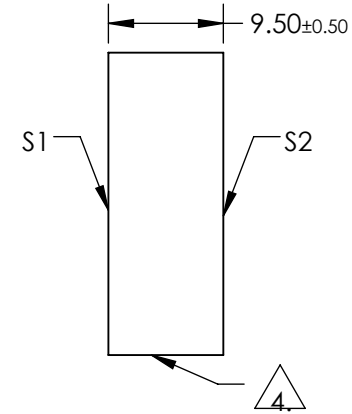
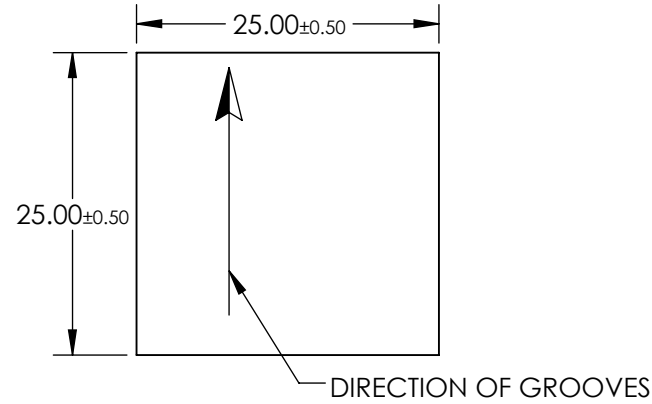

**FOR INFORMATION ONLY:  
DO NOT MANUFACTURE  
PARTS TO THIS DRAWING**

SPECIFICATIONS SUBJECT TO CHANGE WITHOUT NOTICE  
DIMENSIONS ARE FOR REFERENCE ONLY

**EO**® Edmund Optics®

	S1	S2	THIRD ANGLE PROJECTION		TITLE	GRATING DIFF 900GR 500nm 25x25	
SHAPE	PLANO	PLANO	ALL DIMS IN	mm	DWG NO	64404	SHEET 1 OF 1
CLEAR APERTURE	22.5 x 22.5	22.5 x 22.5					