

NOTES:

1. SUBSTRATE:
FUSED SILICA
2. S2 TO BE PARALLEL WITH S1 TO WITHIN < 1 ARCMIN
3. COATING (APPLY ACROSS CLEAR APERTURE)
S1 & S2: R(AVG) ≤ 1.5% FROM 250-700nm
R(ABS) ≤ 1.0% FROM 350-450nm
4. FINE GRIND SURFACE
5. RoHS COMPLIANT

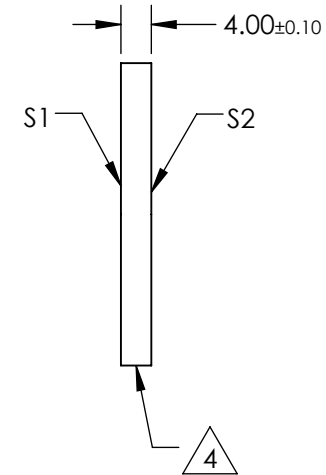
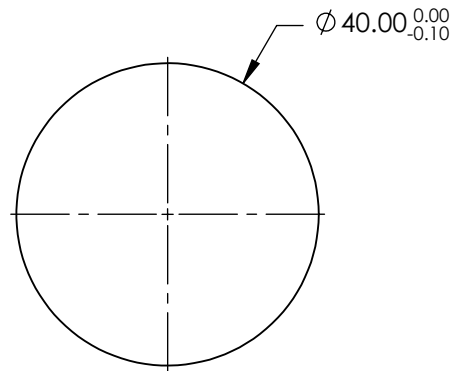
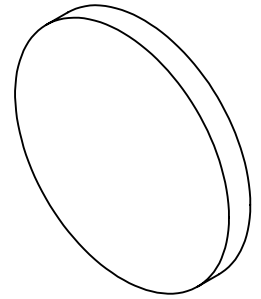

**FOR INFORMATION ONLY:
DO NOT MANUFACTURE
PARTS TO THIS DRAWING**

SPECIFICATIONS SUBJECT TO CHANGE WITHOUT NOTICE
DIMENSIONS ARE FOR REFERENCE ONLY

	S1	S2
SHAPE	PLANO	PLANO
SURFACE QUALITY	40-20	40-20
CLEAR APERTURE (mm)	Ø36.00	Ø36.00
BEVEL	PROTECTIVE AS NEEDED	PROTECTIVE AS NEEDED



ALL DIMS IN mm

EO® Edmund Optics®

TITLE

40mm DIA., 4mm THICK, UV-VIS COATED,
λ/4 FUSED SILICA WINDOW

DWG NO

14978

SHEET
1 OF 1