

NOTES:

1. SUBSTRATE:
Fused Silica (Corning 7980)
2. TEMPERATURE RANGE:
-40 TO +170 °C

**FOR INFORMATION ONLY:
DO NOT MANUFACTURE
PARTS TO THIS DRAWING**

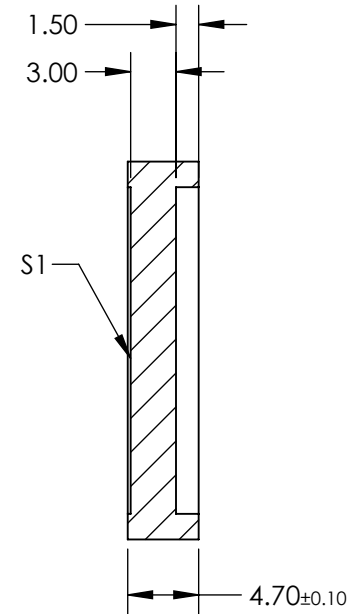
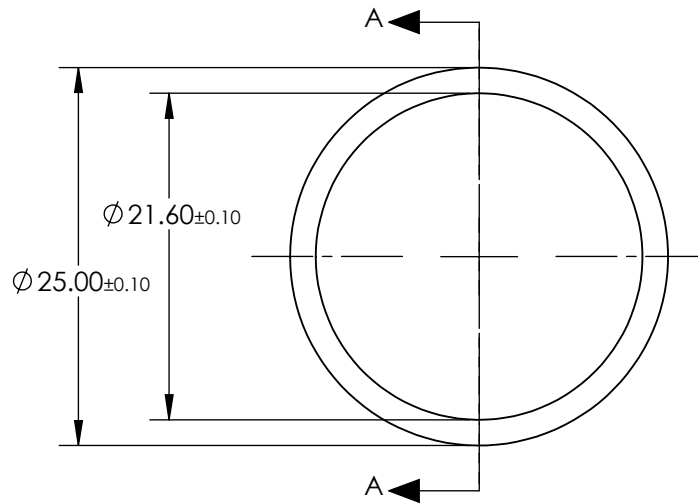
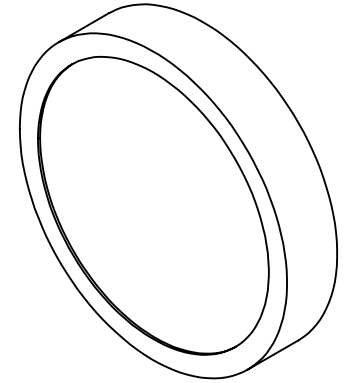

SECTION A-A

SPECIFICATIONS SUBJECT TO CHANGE WITHOUT NOTICE
DIMENSIONS ARE FOR REFERENCE ONLY

	S1
SPECTRAL RANGE	200 - 1500nm
CLEAR APERTURE (mm)	$\varnothing 21.6 \pm 0.1$
DIFFUSING ANGLE	$2 \pm 1^\circ$
TRANSMISSION EFFICIENCY	90%



ALL DIMS IN

mm

EO® **Edmund Optics**®

TITLE

5° DIFFUSING ANGLE 25mm DIA., UV
HOLOGRAPHIC DIFFUSER

DWG NO

55849

SHEET
1 OF 1