

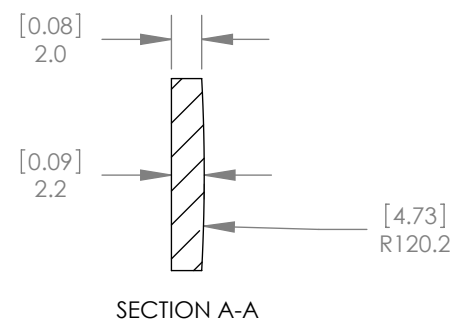

1:1 ISOMETRIC VIEW FOR REFERENCE ONLY

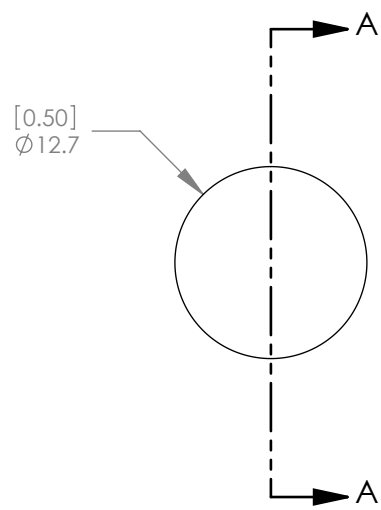

NOTES/SPECIFICATIONS:

- DESIGN WAVELENGTH: 10.6µm
- FOCAL LENGTH: 40.00mm ± 1%
- BACK FOCAL LENGTH (REF): 39.46mm
- CLEAR APERTURE: >80%
- SURFACE QUALITY: 60-40 SCRATCH-DIG
- CENTRATION: <3 arcmin
- DIAMETER TOLERANCE: +0.0/-0.1mm
- THICKNESS TOLERANCE: ± 0.1mm
- COATING: BBAR Ravg <1.5% FROM 8µm-12µm, 0° AOI, ON BOTH OPTICAL SURFACES

ALL DIMENSIONS ARE IN THE FORM  $\frac{[in]}{mm}$ .  
THIS DRAWING IS FOR INFORMATION ONLY  
NOT INTENDED FOR MANUFACTURING

**THORLABS INC.** PO BOX 366  
NEWTON NJ

	NAME	DATE
DRAWN	WD	8/27/2009
ENG APPR.	BW	9/03/2009
MFG APPR.	PM	9/08/2009

TITLE: Ge Plano-Convex Lens, f = 40.00 mm,  
DIA = 12.70 mm, BBAR: 8-12µm

**PROPRIETARY AND CONFIDENTIAL**  
THE INFORMATION CONTAINED IN THIS DRAWING IS THE SOLE PROPERTY OF THORLABS, INC. ANY REPRODUCTION IN PART OR AS A WHOLE WITHOUT THE WRITTEN PERMISSION OF THORLABS, INC. IS PROHIBITED.

MATERIAL: GERMANIUM	SIZE A	REV. A
SCALE: 2:1	SHEET 1 OF 1	
DWG. NO. 20115-E01	PART NO. LA9280-F	