

PDA10JT - May 19, 2021

Item # PDA10JT was discontinued on May 19, 2021. For informational purposes, this is a copy of the website content at that time and is valid only for the stated product.

HGCDTE (MCT) AMPLIFIED PHOTODETECTOR WITH TEC

- ▶ Mid-IR Wavelength Range (2.0 - 5.4 μm)
- ▶ Built-In TEC Reduces Thermal Noise
- ▶ Adjustable Gain and Bandwidth Selection



PDA10JT
Post Not Included

Power Supply
Included with
Detector



Side Mounted,
Post Not Included



PDA10JT
Side View,
Post Not Included

[Hide Overview](#)

OVERVIEW

Features

- Sensitive to Mid-IR (MIR) Light from 2.0 - 5.4 μm
- Max Bandwidth of Detector Package: 160 kHz
- Built-In Thermoelectric Cooler Improves Sensitivity
- 1 mm x 1 mm Detector Element
- Post Mountable in Two Orientations
- Internally SM1 (1.035" -40) Threaded
- Location-Specific Power Adapter Included

Thorlabs' PDA10JT(-EC) Amplified Detector is a thermoelectrically cooled photoconductive HgCdTe (mercury cadmium telluride, MCT) detector. It is sensitive to light in the mid-IR spectral range from 2.0 to 5.4 μm . Two rotary switches control the gain amplifier and detector package bandwidth, allowing performance to be optimized for a variety of applications. The gain switch features eight discrete steps from 0 - 40 dB, while the bandwidth switch provides eight discrete steps from 1.25 - 160 kHz. The thermoelectric cooler (TEC) uses a thermistor feedback loop to hold the temperature of the detector element at -30 $^{\circ}\text{C}$, minimizing thermal contributions to the output signal.

For best results, we recommend connecting the output cable (not included) to a 50 Ω termination. Because the detector is AC coupled, it requires a pulsed or chopped input signal. AC-coupled detectors will not see unchopped CW light because they are only sensitive to intensity changes, not absolute intensity.

The detector package incorporates many of the same mechanical features as our other mounted photodetectors. An internal SM1 (1.035" -40) threading allows $\text{\O}1"$ lens tubes to be mounted in front of the detector element. Two 8-32 (M4 in the -EC version) tapped holes connect a $\text{\O}1/2"$ post to the housing in

MIR Photodetector Selection Guide^a

Item # (Detector)	Wavelength Range	Maximum Bandwidth	Thermoelectric Cooler
PDA10DT (InGaAs)	0.9 - 2.57 μm	1,000 kHz	Yes
PDA10D2 (InGaAs)	0.9 - 2.6 μm	25,000 kHz	No
PDA10PT (InAsSb)	1.0 - 5.8 μm	1,600 kHz	Yes
PDA07P2 (InAsSb)	2.7 - 5.3 μm	9 MHz	No
PDA10JT (HgCdTe)	2.0 - 5.4 μm	160 kHz	Yes
PDAVJ8 (HgCdTe)	2.0 - 8.0 μm	100 MHz	No
PDAVJ10 (HgCdTe)	2.0 - 10.6 μm	100 MHz	No
PDAVJ5 (HgCdTe)	2.7 - 5.0 μm	1 MHz	No

- See the *Cross Reference* tab for our full selection of photodetectors.



Click to Enlarge
Side View Showing
Gain and Bandwidth
Adjusters



Click to Enlarge
Top View Showing
Signal Output and
Power Input

one of two perpendicular orientations, as shown in the image at the top of the page. The PDA10JT(-EC) includes a 100 - 240 VAC power adapter. If you require a different adapter plug, please contact Tech Support prior to ordering. An SM1RR Retaining Ring is also included.

This detector's output signal depends nonlinearly on the optical input power; for a plot of this, see the *Graphs* tab. Please note that inhomogeneities at the edges of the active area of the detector can generate unwanted capacitance and resistance effects that distort the time-domain response of the output. Thorlabs therefore recommends that the incident light is well centered on the active area. The SM1 (1.035" -40) threading on the housing can be connected to an SM1 lens tube; the lens tube can be used to mount an iris or pinhole in front of the detector element. Because the detector package protrudes 3.9 mm beyond the front of the threading, optics and optomechanics cannot be attached directly to the housing.

In addition to the HgCdTe detector sold here, Thorlabs manufactures a InAsSb detector with broader wavelength sensitivity and higher bandwidth at the expense of a higher NEP. If a more compact detector housing is desired, we also offer room-temperature amplified photodetectors.

[Hide Specs](#)

S P E C S

All values given below are for a 50 Ω load, unless otherwise stated.

Item #	PDA10JT(-EC)
Optical Specifications	
Wavelength Range	2.0 - 5.4 μm
Peak Wavelength (λ _p)	4.8 μm
Peak Responsivity	300 V/W (Typ.) at Peak Wavelength
Electrical Specifications	
Gain Settings	0, 4, 10, 16, 22, 28, 34, 40 dB (8 Steps)
Bandwidth Settings	1.25, 2.5, 5, 10, 20, 40, 80, or 160 kHz (8 Steps)
Output Voltage ^a	0 - 5 V at 50 Ω 0 - 10 V at High Z
Output Impedance	50 Ω
Output Current	100 mA (Max)
Load Impedance	50 Ω to High Z
Output Offset ^b	20 mV (Typ.) 45 mV (Max)
Thermoelectric Cooler Specifications	
TEC Temperature	-30 °C
TEC Current	0.6 A (Typ.) 1.0 A (Max)
Thermistor	10 kΩ
Physical Specifications	
Detector Element	HgCdTe (MCT)
Active Area	1 mm × 1 mm
Surface Depth	0.11" ± 0.02" (2.90 ± 0.40 mm)
Output	BNC
Detector Size	3" × 2.2" × 2.2" (76.2 mm × 55.9 mm × 55.9 mm)
Weight	Detector: 0.42 lbs (191 g) Power Supply: 0.82 lbs (372 g)
Power Supply	27 W, Location-Specific Power Cord Included
Input Power	100 - 240 VAC, 50 - 60 Hz

Gain (High Z) ^c	
0 dB	0.8 V/V
4 dB	1.6 V/V
10 dB	3.2 V/V
16 dB	6.3 V/V
22 dB	12.6 V/V
28 dB	25.2 V/V
34 dB	50.1 V/V
40 dB	100 V/V

c. The gain for a 50 Ω impedance is one-half of the gain for high Z.

Noise-Equivalent Power (NEP) Values ^d	
Gain	NEP
0 dB	1.43 × 10 ⁻⁹ W/Hz ^{1/2}
4 dB	7.62 × 10 ⁻¹⁰ W/Hz ^{1/2}
10 dB	4.05 × 10 ⁻¹⁰ W/Hz ^{1/2}
16 dB	2.78 × 10 ⁻¹⁰ W/Hz ^{1/2}
22 dB	2.15 × 10 ⁻¹⁰ W/Hz ^{1/2}
28 dB	2.10 × 10 ⁻¹⁰ W/Hz ^{1/2}
34 dB	1.97 × 10 ⁻¹⁰ W/Hz ^{1/2}
40 dB	1.84 × 10 ⁻¹⁰ W/Hz ^{1/2}

d. Measured at λ_p with a 160 kHz bandwidth and a 50 Ω impedance.

Storage Temperature	0 to 85 °C
Operating Temperature	0 to 30 °C

- Saturation of the output voltage may cause damage to the HgCdTe (MCT) detector element.
- Offset after the temperature has stabilized at each gain step. The worst-case offset is for the 40 dB gain step.

[Hide Graphs](#)

GRAPHS

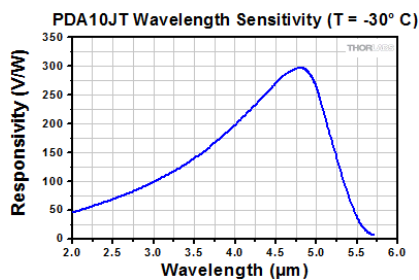

Click to Enlarge
Excel Spreadsheet Containing Raw Data
The graph above is for the 0 dB gain setting.

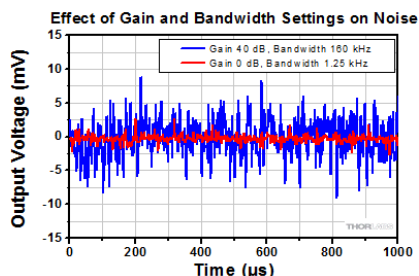

Click to Enlarge
These traces compare the noise level for the lowest gain and bandwidth settings to the noise level for the highest gain and bandwidth settings.

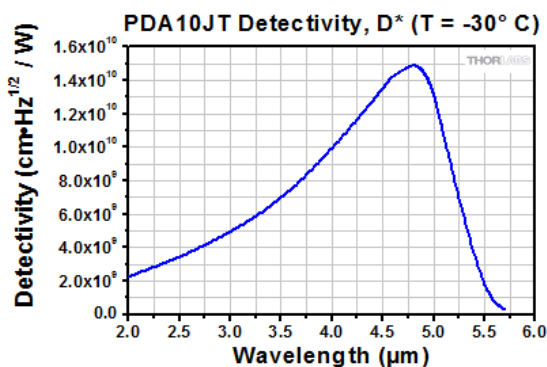

Click to Enlarge
The graph above is for the 0 dB gain setting.

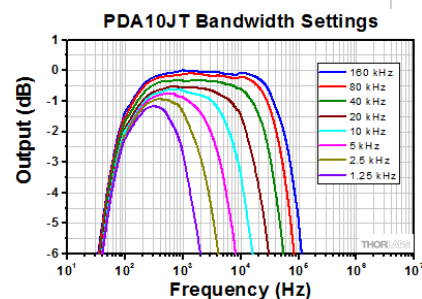

Click to Enlarge
Excel Spreadsheet Containing Raw Data

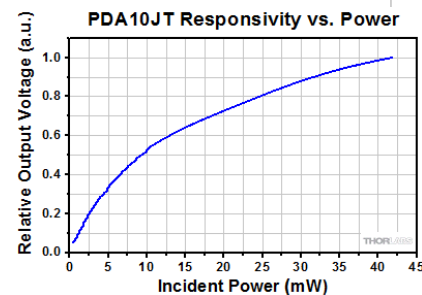

Click to Enlarge
This trace shows that the responsivity varies with input power. For example, increasing the power from 2.5 mW to 5 mW (a difference of 2.5 mW) produces a greater signal change than increasing the power from 25 mW to 27.5 mW (also a difference of 2.5 mW).

Detectivity, D^* , is defined as:

$$D^* = \frac{\sqrt{A \cdot \Delta f}}{NEP}$$

where A is the area of the photosensitive region of the detector, Δf is the effective noise bandwidth, and NEP is the noise-equivalent power.

[Hide Pin Diagrams](#)

PIN DIAGRAMS

Output Signal
BNC Female

Power Input
4-Pin Female

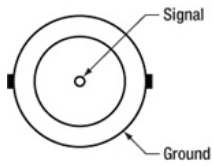

0 - 5 V at 50 Ω
 0 - 10 V at High Z
 100 mA Max Current

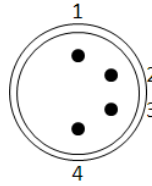

Pin	Connection
1	-12 V
2	Ground
3	+5 V
4	+12 V

[Hide Photodiode Tutorial](#)

PHOTODIODE TUTORIAL

Photodiode Tutorial

Theory of Operation

A junction photodiode is an intrinsic device that behaves similarly to an ordinary signal diode, but it generates a photocurrent when light is absorbed in the depleted region of the junction semiconductor. A photodiode is a fast, highly linear device that exhibits high quantum efficiency based upon the application and may be used in a variety of different applications.

It is necessary to be able to correctly determine the level of the output current to expect and the responsivity based upon the incident light. Depicted in Figure 1 is a junction photodiode model with basic discrete components to help visualize the main characteristics and gain a better understanding of the operation of Thorlabs' photodiodes.

$$I_{OUT} = I_{DARK} + I_{PD}$$

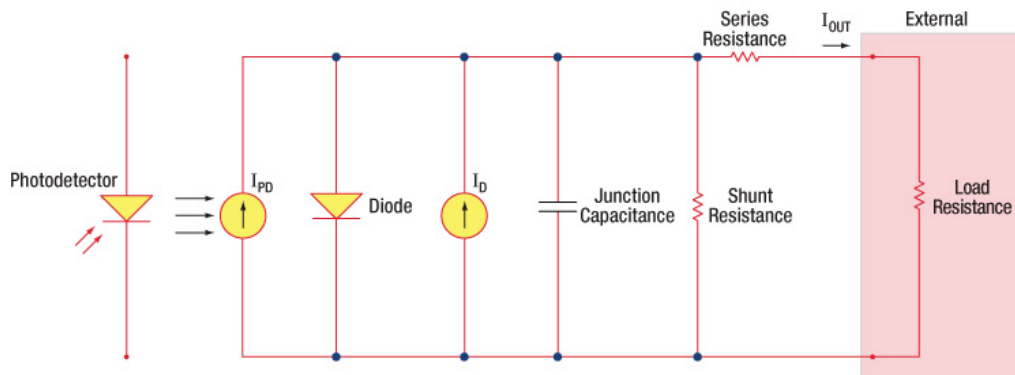

Figure 1: Photodiode Model

Photodiode Terminology

Responsivity

The responsivity of a photodiode can be defined as a ratio of generated photocurrent (I_{PD}) to the incident light power (P) at a given wavelength:

$$R(\lambda) = \frac{I_{PD}}{P}$$

Modes of Operation (Photoconductive vs. Photovoltaic)

A photodiode can be operated in one of two modes: photoconductive (reverse bias) or photovoltaic (zero-bias). Mode selection depends upon the application's speed requirements and the amount of tolerable dark current (leakage current).

Photoconductive

In photoconductive mode, an external reverse bias is applied, which is the basis for our DET series detectors. The current measured through the circuit indicates illumination of the device; the measured output current is linearly proportional to the input optical power. Applying a reverse bias increases the width of the depletion junction producing an increased responsivity with a decrease in junction capacitance and produces a very linear response. Operating under these conditions does tend to produce a larger dark current, but this can be limited based upon the photodiode material. (Note: Our DET detectors are reverse biased and cannot be operated under a forward bias.)

Photovoltaic

In photovoltaic mode the photodiode is zero biased. The flow of current out of the device is restricted and a voltage builds up. This mode of operation exploits the photovoltaic effect, which is the basis for solar cells. The amount of dark current is kept at a minimum when operating in photovoltaic mode.

Dark Current

Dark current is leakage current that flows when a bias voltage is applied to a photodiode. When operating in a photoconductive mode, there tends to be a higher dark current that varies directly with temperature. Dark current approximately doubles for every 10 °C increase in temperature, and shunt resistance tends to double for every 6 °C rise. Of course, applying a higher bias will decrease the junction capacitance but will increase the amount of dark current present.

The dark current present is also affected by the photodiode material and the size of the active area. Silicon devices generally produce low dark current compared to germanium devices which have high dark currents. The table below lists several photodiode materials and their relative dark currents, speeds, sensitivity, and costs.

Material	Dark Current	Speed	Spectral Range	Cost
Silicon (Si)	Low	High Speed	Visible to NIR	Low
Germanium (Ge)	High	Low Speed	NIR	Low
Gallium Phosphide (GaP)	Low	High Speed	UV to Visible	Moderate
Indium Gallium Arsenide (InGaAs)	Low	High Speed	NIR	Moderate
Indium Arsenide Antimonide (InAsSb)	High	Low Speed	NIR to MIR	High
Extended Range Indium Gallium Arsenide (InGaAs)	High	High Speed	NIR	High
Mercury Cadmium Telluride (MCT, HgCdTe)	High	Low Speed	NIR to MIR	High

Junction Capacitance

Junction capacitance (C_j) is an important property of a photodiode as this can have a profound impact on the photodiode's bandwidth and response. It should be noted that larger diode areas encompass a greater junction volume with increased charge capacity. In a reverse bias application, the depletion width of the junction is increased, thus effectively reducing the junction capacitance and increasing the response speed.

Bandwidth and Response

A load resistor will react with the photodetector junction capacitance to limit the bandwidth. For best frequency response, a 50 Ω terminator should be used in conjunction with a 50 Ω coaxial cable. The bandwidth (f_{BW}) and the rise time response (t_r) can be approximated using the junction capacitance (C_j) and the load resistance (R_{LOAD}):

$$f_{BW} = 1 / (2 * \pi * R_{LOAD} * C_j)$$

$$t_r = 0.35 / f_{BW}$$

Noise Equivalent Power

The noise equivalent power (NEP) is the generated RMS signal voltage generated when the signal to noise ratio is equal to one. This is useful, as the NEP determines the ability of the detector to detect low level light. In general, the NEP increases with the active area of the detector and is given by the following equation:

$$NEP = \frac{\text{Incident Energy} * \text{Area}}{\frac{S}{N} * \sqrt{\Delta f}}$$

Here, S/N is the Signal to Noise Ratio, Δf is the Noise Bandwidth, and Incident Energy has units of W/cm². For more information on NEP, please see Thorlabs' Noise Equivalent Power White Paper.

Terminating Resistance

A load resistance is used to convert the generated photocurrent into a voltage (V_{OUT}) for viewing on an oscilloscope:

$$V_{OUT} = I_{OUT} * R_{LOAD}$$

Depending on the type of the photodiode, load resistance can affect the response speed. For maximum bandwidth, we recommend using a 50 Ω coaxial cable with a 50 Ω terminating resistor at the opposite end of the cable. This will minimize ringing by matching the cable with its characteristic impedance. If bandwidth is not important, you may increase the amount of voltage for a given light level by increasing R_{LOAD} . In an unmatched termination, the length of the coaxial cable can have a profound impact on the response, so it is recommended to keep the cable as short as possible.

Shunt Resistance

Shunt resistance represents the resistance of the zero-biased photodiode junction. An ideal photodiode will have an infinite shunt resistance, but actual values may range from the order of ten Ω to thousands of $M\Omega$ and is dependent on the photodiode material. For example, an InGaAs detector has a shunt resistance on the order of 10 $M\Omega$ while a Ge detector is in the $k\Omega$ range. This can significantly impact the noise current on the photodiode. For most applications, however, the high resistance produces little effect and can be ignored.

Series Resistance

Series resistance is the resistance of the semiconductor material, and this low resistance can generally be ignored. The series resistance arises from the contacts and the wire bonds of the photodiode and is used to mainly determine the linearity of the photodiode under zero bias conditions.

Common Operating Circuits

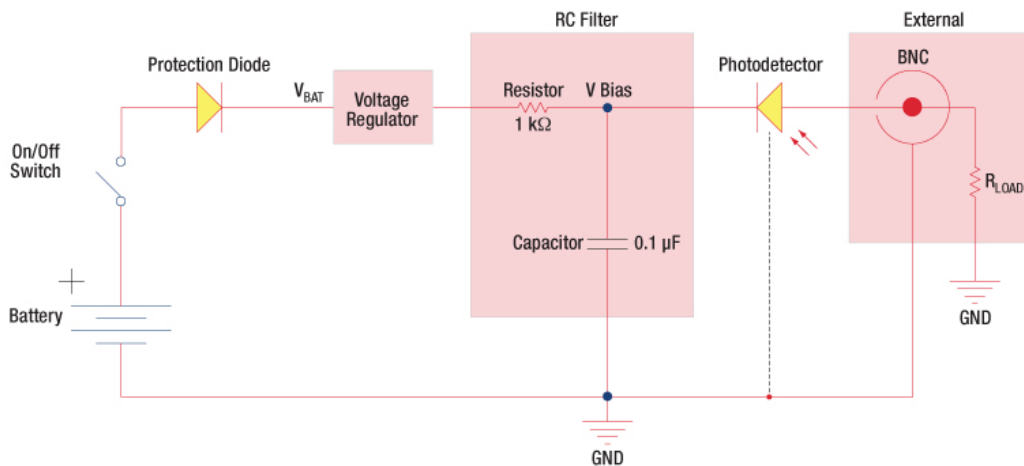

Figure 2: Reverse-Biased Circuit (DET Series Detectors)

The DET series detectors are modeled with the circuit depicted above. The detector is reverse biased to produce a linear response to the applied input light. The amount of photocurrent generated is based upon the incident light and wavelength and can be viewed on an oscilloscope by attaching a load resistance on the output. The function of the RC filter is to filter any high-frequency noise from the input supply that may contribute to a noisy output.

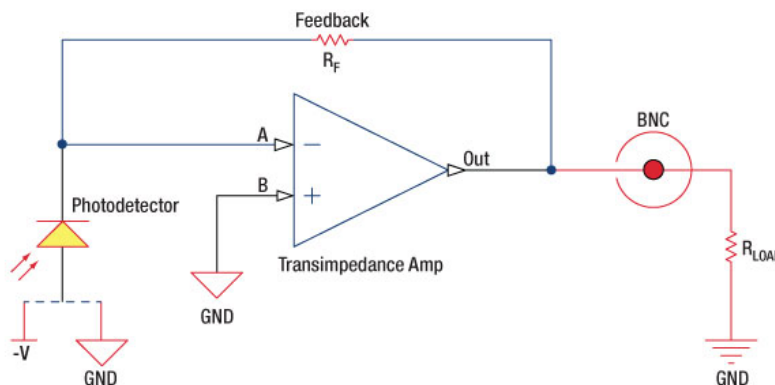

Figure 3: Amplified Detector Circuit

One can also use a photodetector with an amplifier for the purpose of achieving high gain. The user can choose whether to operate in Photovoltaic or Photoconductive modes. There are a few benefits of choosing this active circuit:

- Photovoltaic mode: The circuit is held at zero volts across the photodiode, since point A is held at the same potential as point B by the operational amplifier. This eliminates the possibility of dark current.
- Photoconductive mode: The photodiode is reversed biased, thus improving the bandwidth while lowering the junction capacitance. The gain of the detector is dependent on the feedback element (R_f). The bandwidth of the detector can be calculated using the following:

$$f(-3dB) = \sqrt{\frac{GBP}{4\pi * R_f * C_D}}$$

where GBP is the amplifier gain bandwidth product and C_D is the sum of the junction capacitance and amplifier capacitance.

Effects of Chopping Frequency

The photoconductor signal will remain constant up to the time constant response limit. Many detectors, including PbS, PbSe, HgCdTe (MCT), and InAsSb, have a typical $1/f$ noise spectrum (i.e., the noise decreases as chopping frequency increases), which has a profound impact on the time constant at lower frequencies.

The detector will exhibit lower responsivity at lower chopping frequencies. Frequency response and detectivity are maximized for

$$f_c = \frac{1}{2\pi\tau_r}$$

[Hide Cross Reference](#)

CROSS REFERENCE

The following table lists Thorlabs' selection of photodiodes and photoconductive detectors. Item numbers in the same row contain the same detector element.

Photodetector Cross Reference						
Wavelength	Material	Unmounted Photodiode	Mounted Photodiode	Biased Detector	Amplified Detector	Amplified Detector, OEM Package
150 - 550 nm	GaP	-	SM05PD7A	DET25K2	PDA25K2	-
200 - 1100 nm	Si	FDS010	SM05PD2A SM05PD2B	DET10A2	PDA10A2	-
	Si	-	SM1PD2A	-	-	-
320 - 1000 nm	Si	-	-	-	PDA8A2	-
320 - 1100 nm	Si	FD11A	SM05PD3A	-	PDF10A2	-
	Si	- ^a	-	DET100A2 ^a	PDA100A2 ^a	PDAPC2 ^a
340 - 1100 nm	Si	FDS10X10	-	-	-	-
350 - 1100 nm	Si	FDS100 FDS100-CAL ^b	SM05PD1A SM05PD1B	DET36A2	PDA36A2	PDAPC1
	Si	FDS1010 FDS1010-CAL ^b	SM1PD1A SM1PD1B	-	-	-
400 - 1000 nm	Si	-	-	-	PDA015A(M) FPD310-FS-VIS FPD310-FC-VIS FPD510-FC-VIS FPD510-FS-VIS FPD610-FC-VIS FPD610-FS-VIS	-

400 - 1100 nm	Si	FDS015 ^c	-	-	-	-
	Si	FDS025 ^c FDS02 ^d	-	DET02AFC(/M) DET025AFC(/M) DET025A(/M) DET025AL(/M)	-	-
400 - 1700 nm	Si & InGaAs	DSD2	-	-	-	-
500 - 1700 nm	InGaAs	-	-	DET10N2	-	-
750 - 1650 nm	InGaAs	-	-	-	PDA8GS	-
800 - 1700 nm	InGaAs	FGA015	-	-	PDA015C(/M)	-
	InGaAs	FGA21 FGA21-CAL ^b	SM05PD5A	DET20C2	PDA20C2 PDA20CS2	-
	InGaAs	FGA01 ^c FGA01FC ^d	-	DET01CFC(/M)	-	-
	InGaAs	FDGA05 ^c	-	-	PDA05CF2	-
	InGaAs	-	-	DET08CFC(/M) DET08C(/M) DET08CL(/M)	PDF10C/M	-
800 - 1800 nm	Ge	FDG03 FDG03-CAL ^b	SM05PD6A	DET30B2	PDA30B2	-
	Ge	FDG50	-	DET50B2	PDA50B2	-
	Ge	FDG05	-	-	-	-
900 - 1700 nm	InGaAs	FGA10	SM05PD4A	DET10C2	PDA10CS2	-
900 - 2600 nm	InGaAs	FD05D	-	DET05D2	-	-
		FD10D	-	DET10D2	PDA10D2	-
950 - 1650 nm	InGaAs	-	-	-	FPD310-FC-NIR FPD310-FS-NIR FPD510-FC-NIR FPD510-FS-NIR FPD610-FC-NIR FPD610-FS-NIR	-
1.0 - 5.8 μ m	InAsSb	-	-	-	PDA10PT(-EC)	-
2.0 - 5.4 μ m	HgCdTe (MCT)	-	-	-	PDA10JT(-EC)	-
2.0 - 8.0 μ m	HgCdTe (MCT)	VML8T0 VML8T4 ^e	-	-	PDAVJ8	-
2.0 - 10.6 μ m	HgCdTe (MCT)	VML10T0 VML10T4 ^e	-	-	PDAVJ10	-
2.7 - 5.0 μ m	HgCdTe (MCT)	VL5T0	-	-	PDAVJ5	-
2.7 - 5.3 μ m	InAsSb	-	-	-	PDA07P2	-

- If you are interested in purchasing the bare photodiode incorporated in these detectors without the printed circuit board, please contact Tech Support.
- ^a Calibrated Unmounted Photodiode
- ^b Unmounted TO-46 Can Photodiode
- ^c Unmounted TO-46 Can Photodiode with FC/PC Bulkhead
- ^d Photovoltaic Detector with Thermoelectric Cooler

[Hide HgCdTe \(MCT\) Detector with TEC: 2.0 - 5.4 \$\mu\$ m](#)

HgCdTe (MCT) Detector with TEC: 2.0 - 5.4 μ m

Item #	PDA10JT(-EC)
Click Image to Enlarge	

- ▶ Sensitive to Chopped or Pulsed Mid-IR Light from 2.0 μ m to 5.4 μ m
- ▶ Detector is Cooled to -30 °C to Reduce Thermal Noise
- ▶ 1 mm x 1 mm Active Area
- ▶ Variable Gain Amplifier (0.8 V/V to 100 V/V)
- ▶ Variable Bandwidth (1.25 kHz to 160 kHz)
- ▶ Internal SM1 (1.035"-40) Threading
- ▶ Nonlinear Dependence of Output Voltage on Optical Power (See *Graphs* Tab for Details)



► Location-Specific Power Adapter Included

Detector Material	HgCdTe (MCT)
Wavelength Range (λ_P)	2.0 - 5.4 μm
Peak Wavelength	4.8 μm
Peak Responsivity	300 V/W (Typ.) at λ_P
Active Area	1 mm x 1 mm
Window Material	Borosilicate Glass
Gain Settings	8 Steps: 0, 4, 10, 16, 22, 28, 34, or 40 dB
Bandwidth Settings	8 Steps from 1.25 kHz to 160 kHz
Noise-Equivalent Power (NEP)	$1.84 \times 10^{-10} \text{ W/Hz}^{1/2}$ (for 40 dB Gain and 160 kHz Bandwidth)

More detailed specifications are available in the *Specs* tab.

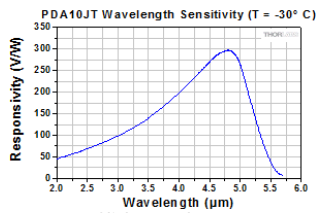

Click to Enlarge

[Click Here for Raw Data](#)

The graph above is for the 0 dB gain setting.

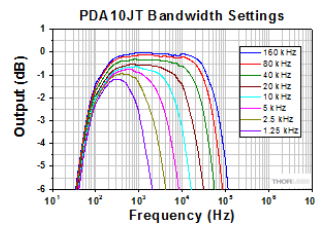

Click to Enlarge

[Click Here for Raw Data](#)

Part Number	Description	Price	Availability
PDA10JT-EC	HgCdTe Amplified Detector with TEC, 2.0 - 5.4 μm , AC-Coupled Amplifier, 1 mm ² , 100 - 240 VAC	\$4,448.59	Today
PDA10JT	HgCdTe Amplified Detector with TEC, 2.0 - 5.4 μm , AC-Coupled Amplifier, 1 mm ² , 100 - 240 VAC	\$4,448.59	Lead Time



THORLABS
www.thorlabs.com

PDA10JT
Temperature Controlled
MCT Amplified Detector
2.0 - 5.4 μm

CE

OUTPUT

POWER IN





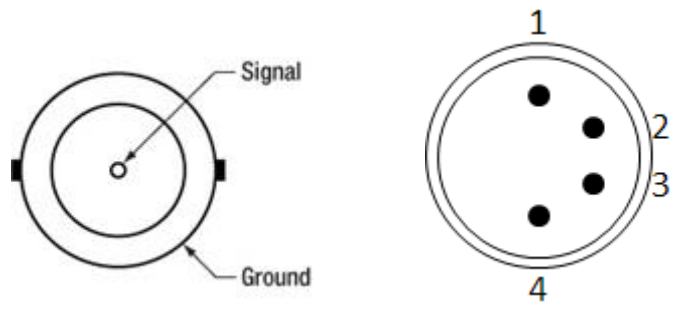
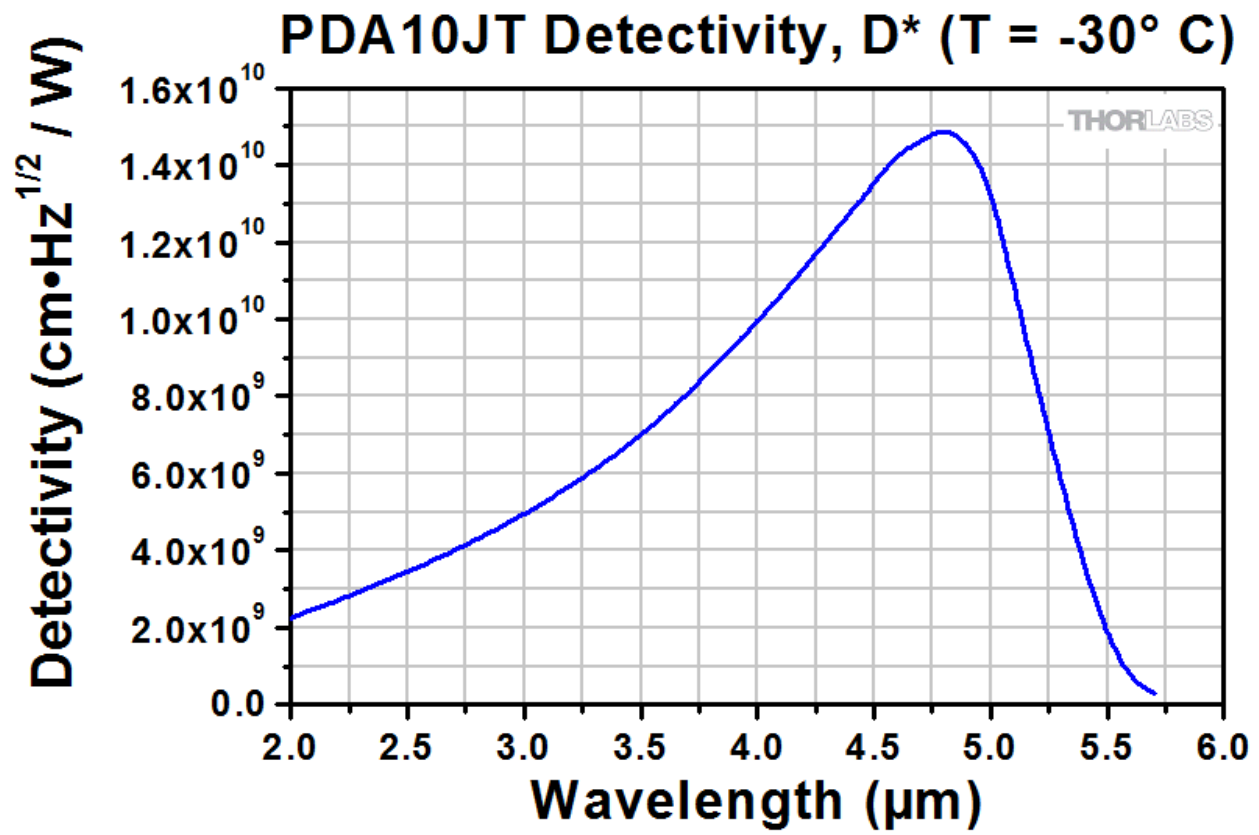

PDA10JT Wavelength Sensitivity (T = -30° C)

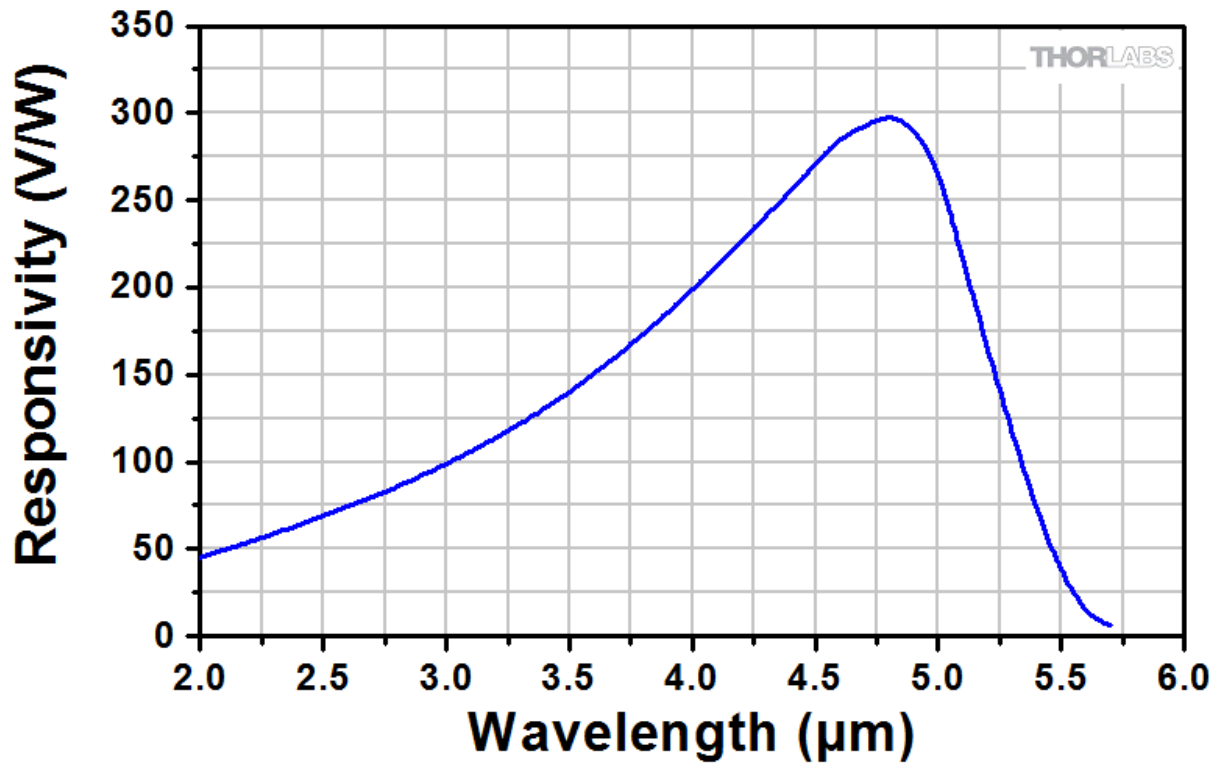

PDA10JT Bandwidth Settings

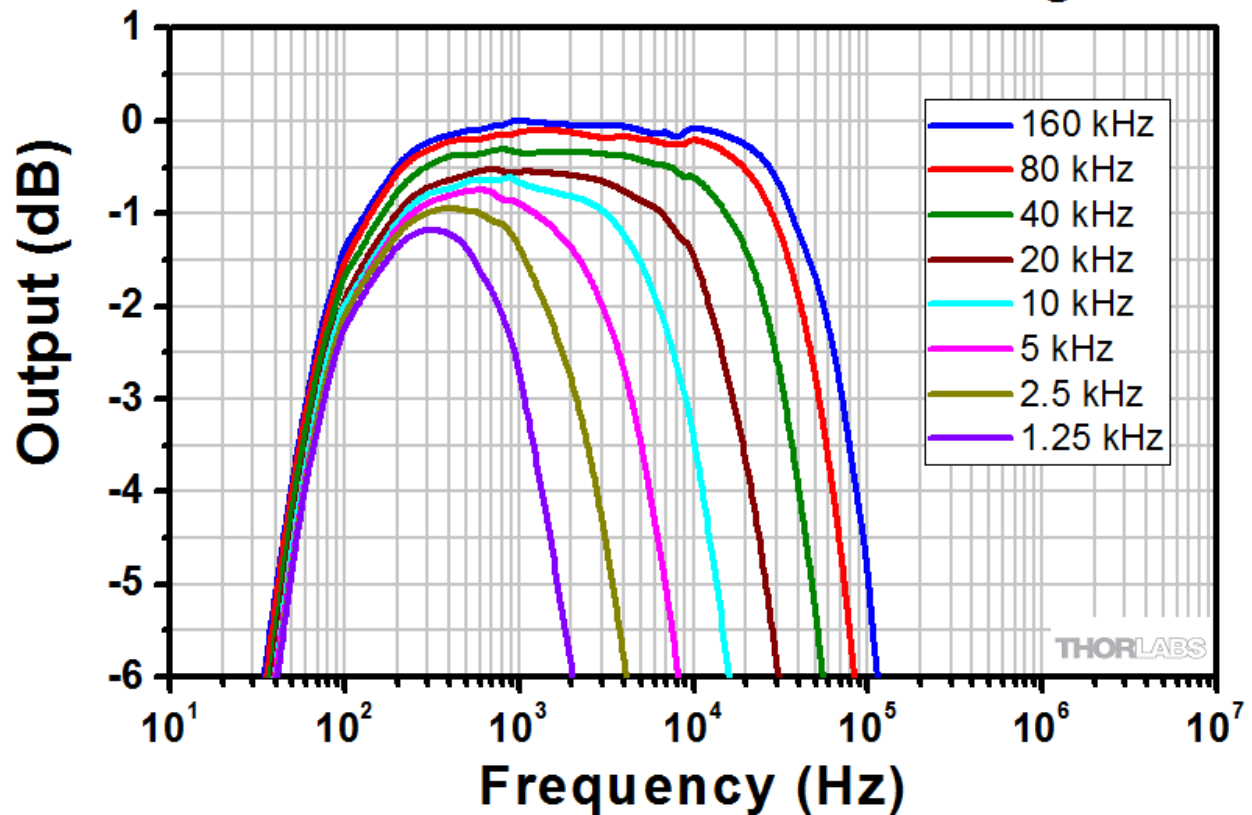

Effect of Gain and Bandwidth Settings on Noise

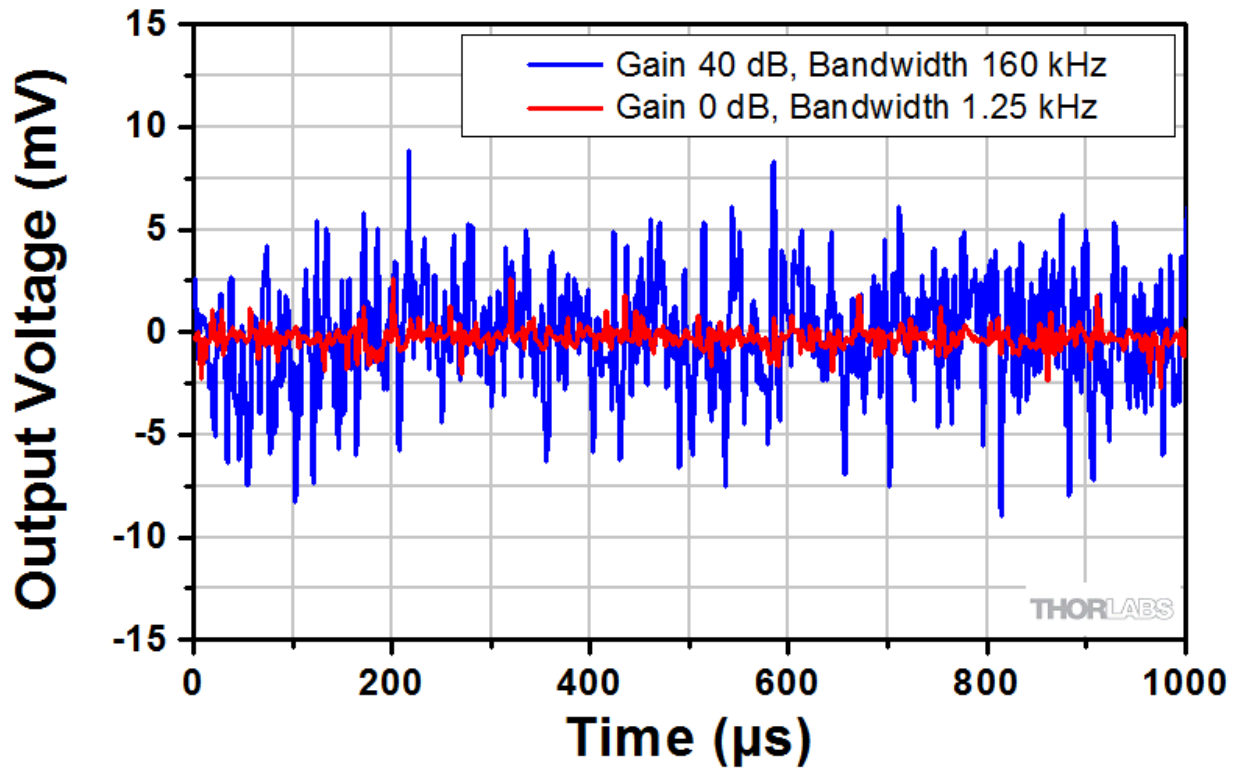

PDA10JT Responsivity vs. Power

