

NOTES:

1. SUBSTRATE: FUSED SILICA
2. SURFACE S2 TO BE PARALLEL TO SURFACE S1 TO WITHIN <3 ARCMIN

3. COATING (APPLY ACROSS COATING APERTURE)

S1: Laser V-Coat (532nm)
 R(ABS) <0.25% @ 532nm @ 0 ±5° AOI

DAMAGE THRESHOLD,
 PULSED: 10 J/cm² @ 532nm, 20ns, 20Hz

S2: NONE

△ 4. FINE GRIND SURFACE

5. ROHS: COMPLIANT

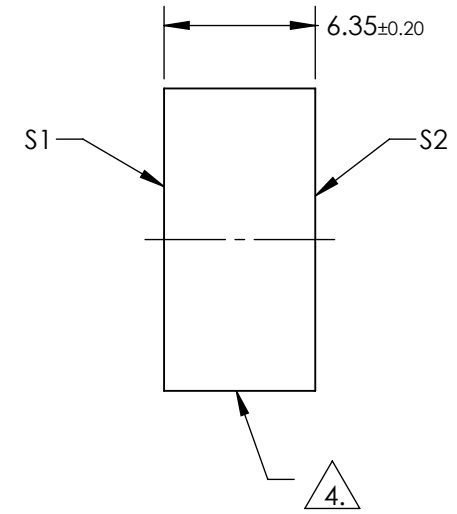
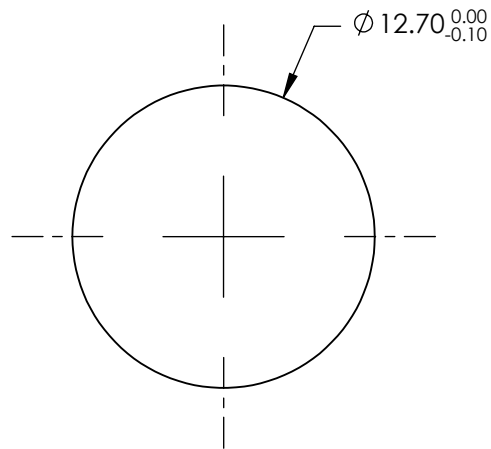

**FOR INFORMATION ONLY:
 DO NOT MANUFACTURE
 PARTS TO THIS DRAWING**

SPECIFICATIONS SUBJECT TO CHANGE WITHOUT NOTICE
 DIMENSIONS ARE FOR REFERENCE ONLY

	S1	S2
SHAPE	PLANO	PLANO
SURFACE QUALITY	10-5	10-5
CLEAR APERTURE	90 %	90 %
BEVEL	PROTECTIVE AS NEEDED	PROTECTIVE AS NEEDED



ALL DIMS IN mm

EO® Edmund Optics®

TITLE 12.7mm Dia. 532nm, Nd:YAG Laser Line Beam Sampler

DWG NO 39008 SHEET 1 OF 1