

## PDA20C/M - February 27, 2019

Item # PDA20C/M was discontinued on February 27, 2019. For informational purposes, this is a copy of the website content at that time and is valid only for the stated product.

### INGAAS FREE-SPACE AMPLIFIED PHOTODETECTORS

Wavelength Ranges Between 800 - 2600 nm  
Maximum Bandwidths up to 1.5 GHz  
Sensitivities Down to Femtowatt Powers  
Fixed and Switchable Gain Versions

#### Application Idea

PDA Series Detector with  $\varnothing 1"$  Lens  
Tube Attached to a 30 mm Cage  
System



**PDA10CS2**  
Switchable Gain  
13 MHz Max Bandwidth



**PDA015C**  
Fixed Gain  
380 MHz Max Bandwidth



**FPD310-FS-NIR**  
Switchable Gain  
1.5 GHz Max Bandwidth



**Features**

- Wavelength Ranges within 800 to 2600 nm
- Low-Noise Amplification with Fixed or Switchable Gain
- Load Impedances 50 Ω and Higher for ≥3 kHz Bandwidth Versions
- Free-Space Optical Coupling

We offer a selection of Indium Gallium Arsenide (InGaAs) Free-Space Amplified Photodetectors that are sensitive to light in the NIR wavelength range. Thorlabs' amplified photodetectors feature a built-in, low-noise transimpedance amplifier (TIA) which, for select detectors, is followed by a voltage amplifier. Menlo Systems' FPD series amplified photodetectors have a built-in radio frequency (RF) or transimpedance amplifier. We offer fixed-gain versions that possess a fixed maximum bandwidth and total transimpedance gain, as well as switchable-gain versions with two or eight gain settings.

Thorlabs' photodetectors are designed to meet a range of requirements, with offerings that include the 380 MHz PDA015C with an impulse response of 1 ns, the high-sensitivity PDF10C with a noise equivalent power (NEP) of 7.5 fW/Hz<sup>1/2</sup>, and the switchable-gain PDA20CS2 with eight switchable maximum gain (bandwidth) combinations from 1.51 kV/A (11 MHz) to 4.75 MV/A (3 kHz). The PDF10C with femtowatt sensitivity is a low-frequency device that should only be terminated into high impedance (Hi-Z) loads, while all other of our InGaAs PDA amplified photodetectors are capable of driving loads from 50 Ω to Hi-Z.



Click to Enlarge  
The PDA05CF2 with the  
Included ±12 V Power Supply.  
Replacement power supplies  
are sold below.

Every PDA and PDF detector has internal SM05 (0.535"-40) threading and external SM1 (1.035"-40) threading. Except for some select detectors, each unit's housing features 8-32 tapped holes (M4 for -EC and /M models). The PDA05CF2, PDA10D2, PDA10CS2, and PDA20CS2 feature a new housing with two universal mounting holes that accept both 8-32 and M4 threads. For more information about the location of these mounting points and mounting these units, please see the *Housing Features* and *Mounting Options* tabs.

Menlo Systems' FPD series photodetectors are easy-to-use InGaAs-PIN photodiode packages with an integrated high-gain, low-noise RF (FPD310-FS-NIR) or transimpedance (FPD510-FS-NIR and FPD610-FS-NIR) amplifier. The FPD310-FS-NIR is recommended, in particular, for applications like pulse shape and low-noise radio frequency extraction. This photodetector is optimized for high gain, high bandwidths, extremely short rise times, and high signal-to-noise ratio. It has a 0.5 ns rise time and a switchable gain between two settings, allowing for an optimal performance for the user's application. The FPD510-FS-NIR and FPD610-FS-NIR have a fixed gain and are optimized for highest signal-to-noise-ratio for detection of low level optical beat signals at frequencies up to 250 MHz and 600 MHz, respectively. The FPD510-FS-NIR has a rise time of 2 ns, while the FPD610-FS-NIR has a 1 ns rise time. The 3 dB bandwidth of these DC-coupled devices is 200 MHz for the FPD510-FS-NIR and 500 MHz for the FPD610-FS-NIR. The compact design of the FPD detectors allows for easy OEM integration. The housing of each Menlo detector features one M4 tapped hole for post mounting.

**Power Supply**

A ±12 V linear power supply is included with each amplified photodetector. A power supply that supports input voltages of 115 and 230 VAC and is compatible with these detectors is also available separately below. Before connecting the power supply to the mains, ensure that the line voltage switch on the power supply module is set to the proper voltage range. The power supplies should always be powered up using the power switch on the power supply itself. Hot plugging the unit is not recommended.

Menlo's FPD510-FS-NIR, FPD610-FS-NIR and FPD310-FS-NIR include a low-noise power supply.

For detectors with a fiber coupled input, see InGaAs Fiber-Coupled Amplified Photodetectors.

Item #	Wavelength Range	Bandwidth	NEP
<b>Fixed Gain</b>			
PDA015C(/M)	800 - 1700 nm	DC - 380 MHz	20 pW/Hz <sup>1/2</sup>
PDA05CF2	800 - 1700 nm	DC - 150 MHz	12.6 pW/Hz <sup>1/2</sup>
PDF10C(/M)	800 - 1700 nm	DC - 25 Hz	7.5 x 10 <sup>-3</sup> pW/Hz <sup>1/2</sup>
PDA20C/M	800 - 1700 nm	DC - 5 MHz	22 pW/Hz <sup>1/2</sup>
PDA10D2	900 - 2600 nm	DC - 25 MHz	10.1 pW/Hz <sup>1/2</sup>
FPD510-FS-NIR	950 - 1650 nm	DC - 250 MHz	3.2 pW/Hz <sup>1/2</sup>
FPD610-FS-NIR	950 - 1650 nm	DC - 600 MHz	6.6 pW/Hz <sup>1/2</sup>
<b>Switchable Gain</b>			
PDA20CS2 <sup>a</sup>	800 - 1700 nm	DC - 11 MHz	1.95 - 61 pW/Hz <sup>1/2</sup>
PDA10CS2 <sup>a</sup>	900 - 1700 nm	DC - 13 MHz	1.91 - 46 pW/Hz <sup>1/2</sup>
FPD310-FS-NIR <sup>b</sup>	950 - 1650 nm	1 - 1500 MHz	14.1 pW/Hz <sup>1/2</sup>

- <sup>a</sup> • Switchable with 8 x 10 dB steps.
- <sup>b</sup> • Switchable with 2 steps, 0 and 20 dB.



Click to Enlarge  
Menlo Systems' Detectors  
Include a Location-Specific  
±12 V Power Supply

### Performance Specifications

Item #	Wavelength	Bandwidth	Rise Time	Peak Responsivity	Noise Equivalent Power (NEP) <sup>a</sup>	Active Area	Operating Temperature Range
<b>Fixed Gain</b>							
PDA015C(/M)	800 - 1700 nm	DC - 380 MHz	1.0 ns	0.95 A/W @ 1550 nm	20 pW/Hz <sup>1/2</sup>	0.018 mm <sup>2</sup> (Ø150 µm)	10 to 40 °C
PDA05CF2 <sup>b</sup>	800 - 1700 nm	DC - 150 MHz	2.3 ns	1.04 A/W @ 1590 nm	12.6 pW/Hz <sup>1/2</sup>	0.2 mm <sup>2</sup> (Ø0.5 mm)	10 to 50 °C
PDF10C(/M)	800 - 1700 nm	DC - 25 Hz	19 ms	1.0 A/W @ 1550 nm	7.5 x 10 <sup>-3</sup> pW/Hz <sup>1/2</sup>	0.2 mm <sup>2</sup> (Ø0.5 mm)	18 to 28 °C
PDA20C/M	800 - 1700 nm	DC - 5 MHz	70 ns	1 A/W @ 1550 nm	22 pW/Hz <sup>1/2</sup>	3.14 mm <sup>2</sup> (Ø2.0 mm)	10 to 50 °C
PDA10D2 <sup>b</sup>	900 - 2600 nm	DC - 25 MHz	15 ns	1.35 A/W @ 2300 nm	10.1 pW/Hz <sup>1/2</sup>	0.8 mm <sup>2</sup> (Ø1.0 mm)	10 to 50 °C
FPD510-FS-NIR	950 - 1650 nm	DC - 250 MHz	2 ns	-	3.2 pW/Hz <sup>1/2</sup>	0.07 mm <sup>2</sup> (Ø0.3 mm)	10 to 40 °C
FPD610-FS-NIR	950 - 1650 nm	DC - 600 MHz	1 ns	-	6.6 pW/Hz <sup>1/2</sup>	5 x 10 <sup>-3</sup> mm <sup>2</sup> (Ø0.08 mm)	10 to 40 °C
<b>Switchable Gain</b>							
PDA20CS2 <sup>b</sup>	800 - 1700 nm	DC - 11 MHz <sup>c</sup>	N/A <sup>d</sup>	1.04 A/W @ 1590 nm	1.95 - 61 pW/Hz <sup>1/2</sup>	3.14 mm <sup>2</sup> (Ø2.0 mm)	10 to 40 °C
PDA10CS2 <sup>b</sup>	900 - 1700 nm	DC - 13 MHz <sup>c</sup>	N/A <sup>d</sup>	1.05 A/W @ 1550 nm	1.91 - 46 pW/Hz <sup>1/2</sup>	0.8 mm <sup>2</sup> (Ø1.0 mm)	10 to 40 °C
FPD310-FS-NIR	950 - 1650 nm	1 - 1500 MHz	0.5 ns	-	14.1 pW/Hz <sup>1/2</sup>	5 x 10 <sup>-3</sup> mm <sup>2</sup> (Ø0.08 mm)	10 to 40 °C

- a. NEP is specified at the peak responsivity wavelength. As NEP changes with the gain setting for the switchable-gain versions, an NEP range is given for these.
- b. This detector has a 50 Ω terminator resistor that is in series with the amplifier output. This forms a voltage divider with any load impedance (e.g. 50 Ω load divides signal in half).
- c. This is the maximum possible bandwidth for these amplified photodetectors. Bandwidth varies as a function of gain. For more information see the *Switchable Gain* table below.
- d. Rise times depend on the chosen gain level and wavelength. As one increases the gain of a given optical amplifier, the bandwidth is reduced, and hence, the rise time increases. Please refer to the photodiode tutorial for information on calculating the rise time. Bandwidth specifications for each adjustable photodetector may be found in the table below.

### Gain Specifications

#### Fixed Gain

Item #	Gain w/ Hi-Z Load	Gain w/ 50 Ω Load	Offset (±)	Output Voltage w/ Hi-Z Load	Output Voltage w/ 50 Ω Load
PDA015C(/M)	50 kV/A	25 kV/A	20 mV	0 to 10 V <sup>a</sup>	0 to 5 V <sup>a</sup>
PDA05CF2	10 kV/A	5 kV/A	20 mV	0 to 10 V	0 to 5 V
PDA20C/M	500 kV/A	175 kV/A	25 mV	0 to 10 V	0 to 3.5 V
PDF10C(/M) <sup>b</sup>	1x10 <sup>8</sup> kV/A	-	<150 mV	0 to 10 V	-
PDA10D2	10 kV/A	5 kV/A	75 mV (375 mV Max)	0 to 10 V	0 to 5 V
FPD510-FS-NIR	-	1.5 x 10 <sup>5</sup> V/W	-	-	0 to 1 V
FPD610-FS-NIR	-	2 x 10 <sup>6</sup> V/W	-	-	0 to 1 V

- a. Linear operating range is restricted due to slew rate limitations at maximum bandwidth. See the manual for more details.
- b. Due to its 25 Hz cutoff frequency, operating the PDF10C(/M) with less than high impedance loading is not recommended.

#### Switchable Gain

Item #	Gain Step	Gain w/ Hi-Z Load <sup>a</sup>	Gain w/ 50 Ω Load <sup>a</sup>	Bandwidth	Noise (RMS)	NEP <sup>b</sup>	Offset (±)	Output Voltage w/ Hi-Z Load	Output Voltage w/ 50 Ω Load
PDA20CS2	0	1.51 kV/A	0.75 kV/A	11 MHz	286 µV	61 pW/Hz <sup>1/2</sup>	5 mV (10 mV Max)	0 to 10 V	0 to 5 V
	10	4.75 kV/A	2.38 kV/A	1.5 MHz	201 µV	5.7 pW/Hz <sup>1/2</sup>	6 mV (10 mV Max)		
	20	15 kV/A	7.5 kV/A	1 MHz	236 µV	2.93 pW/Hz <sup>1/2</sup>	6 mV (10 mV Max)		
	30	47.5 kV/A	23.8 kV/A	260 kHz	234 µV	2.19 pW/Hz <sup>1/2</sup>	6 mV (10 mV Max)		
	40	151 kV/A	75 kV/A	90 kHz	240 µV	1.95 pW/Hz <sup>1/2</sup>	6 mV (10 mV Max)		
	50	475 kV/A	238 kV/A	28 kHz	260 µV	2.24 pW/Hz <sup>1/2</sup>	6 mV (10 mV Max)		

Item #	Gain Step	Gain w/ Hi-Z Load <sup>a</sup>	Gain w/ 50 Ω Load <sup>a</sup>	Bandwidth	Noise (RMS)	NEP <sup>b</sup>	Offset (±)	Output Voltage w/ Hi-Z Load	Output Voltage w/ 50 Ω Load
	60	1.5 MV/A	0.75 MV/A	9 kHz	300 μV	2.25 pW/Hz <sup>1/2</sup>	6 mV (10 mV Max)		
	70	4.75 MV/A	2.38 MV/A	3 kHz	396 μV	2.28 pW/Hz <sup>1/2</sup>	8 mV (12 mV Max)		
PDA10CS2	0	1.51 kV/A	0.75 kV/A	13 MHz	264 μV	46 pW/Hz <sup>1/2</sup>	5 mV (10 mV Max)	0 to 10 V	0 to 5 V
	10	4.75 kV/A	2.38 kV/A	1.7 MHz	190 μV	3.7 pW/Hz <sup>1/2</sup>	6 mV (10 mV Max)		
	20	15 kV/A	7.5 kV/A	1.1 MHz	208 μV	2.15 pW/Hz <sup>1/2</sup>	6 mV (10 mV Max)		
	30	47.5 kV/A	23.8 kV/A	300 kHz	212 μV	1.95 pW/Hz <sup>1/2</sup>	6 mV (10 mV Max)		
	40	151 kV/A	75 kV/A	90 kHz	220 μV	1.91 pW/Hz <sup>1/2</sup>	6 mV (10 mV Max)		
	50	475 kV/A	238 kV/A	28 kHz	235 μV	2.17 pW/Hz <sup>1/2</sup>	6 mV (10 mV Max)		
	60	1.5 MV/A	0.75 MV/A	9 kHz	270 μV	2.3 pW/Hz <sup>1/2</sup>	6 mV (10 mV Max)		
	70	4.75 MV/A	2.38 MV/A	3 kHz	361 μV	2.24 pW/Hz <sup>1/2</sup>	8 mV (12 mV Max)		
FPD310-FS-NIR	0	-	$2 \times 10^4 V_{pp}/W$	1 - 1500 MHz	.c,d	14.1 pW/Hz <sup>1/2</sup>	N/A (AC Coupling)	-	200 to 800 mV
	20	-	$2 \times 10^3 V_{pp}/W$					-	20 to 80 mV

- a. Gain figures can also be expressed in units of Ω.
- b. The Noise Equivalent Power is specified at the peak wavelength.
- c. The Dark State Noise Level is -100 dBm (up to 5 MHz).
- d. The Dark State Noise Level is -130 dBm (5 to 1500 MHz).

## Housing Features of the Amplified InGaAs Photodetectors

Please refer to the table below for detailed drawings of each detector.

### PDA and PDF Detectors

Thorlabs' Amplified Photodiode series feature a slim design with many common elements. Each housing features internal SM05 (0.535"-40) threading and external SM1 (1.035"-40) threading, and includes a detachable SM1T1 internally SM1-threaded adapter, as shown to the right. The SM1T1 can hold up to 0.1" (2.8 mm) thick optics. An SM1RR retaining ring is included with every detector, except the PDF10C(M) and PDA20C(M). Each detector can be mounted using a 1/2" Post, as shown in the images below. The PDF10C(M) also includes the TRE(TRE/M) electrically isolated Ø1/2" post adapter. Detectors with universal taps (refer to the table below) have a new housing design that features the active area flush with the front of the housing, simplifying alignments within optomechanical systems. As a convenience, the back panels of these detectors are engraved with the responsivity curve of the photodiodes.

### Lens Tube Compatibility

These detectors can be integrated into various optomechanical systems using the internal SM05 and external SM1 threads. A lens tube can be directly attached to the SM1 threads, making the detectors compatible with lens tube systems. The SM1T1 adapter can be used to mount Ø1" (Ø25.4 mm) optical components, such as optical filters and lenses.

### Cage System Compatibility

The detectors are also cage system compatible, as shown in the two images below right. A CP02 cage plate can be attached directly to the SM1 threads. This attachment method does not require an adapter piece and allows the diode to be as close as possible to the cage plate, which can be important in setups where the light is divergent. Another method for integrating a detector into a cage system is using the included SM1T1 with an SM1T2 adapter. This allows more freedom in choosing the orientation of the detector. Additionally, these detectors can be used with SM1-threaded fiber adapters (sold below).

### Post Mounting

Threaded holes on the housings of the detectors allow the units to be mounted in a horizontal or vertical orientation using a 1/2" Post. This gives the user the option to route the power and BNC cables from above or alongside the beam path, as shown below left. We offer detectors that have metric and imperial versions, as well as detectors that have universal mounting holes that accept 8-32 and M4 threads. Please see the table below for the specific mounting taps of each detector.



Click to Enlarge  
The housings of Thorlabs' detectors feature internal SM05 and external SM1 threads. An SM1T1 SM1 Adapter with internal threads is included with each amplified photodetector, and an SM1RR Retaining Ring is included with the PDA015C, PDA10D2, PDA05CF2, PDA10CS2, and PDA20CS2.



Click to Enlarge  
Top of the housing on our PDA and PDF detector housings. The Power In connector, Output BNC connector, and power indicator LED are located at the top of the housing. The PDA015C detector is shown.



Click to Enlarge  
PDA Photodetector Mounted Horizontally



Click to Enlarge  
[APPLIST]  
[APPLIST]  
PDA Photodetector Connected to an SM1 Lens Tube in a 30 mm Cage System









Click to Enlarge  
[APPLIST]  
[APPLIST]  
PDA Photodetector Integrated into a 30 mm Cage System Using the External SM1 Threads



Click to Enlarge  
[APPLIST]  
[APPLIST]  
PDA Photodetector Integrated into a 30 mm Cage System Using the SM1T1 (included) and SM1T2 Adapter

## FPD Detectors

The housing of each of Menlo Systems' FPD detectors feature one M4 tapped hole on the bottom for post mounting. The power supply connector and output SMA connector are located on the side of the housing.

Detectors	Housing Drawing (Click Icon for Details)	Mounting Taps	SM Thread Compatibility	Dimensions	Output Connector
<b>PDA/PDF Fixed Gain</b>					
PDA05CF2, PDA10D2		Two Universal Taps for 8-32 and M4	Internal SM05 (0.535"-40) External SM1 (1.035"-40)	1.96" x 0.89" x 2.79" (49.8 mm x 22.5 mm x 70.9 mm)	BNC
PDA015C		Two 8-32 Taps (M4 for Metric Version)		1.89" x 0.83" x 2.76" (48.0 mm x 21.1 mm x 70.2 mm)	
PDF10C		Three 8-32 Taps (M4 for Metric Version)		1.70" x 0.83" x 2.57" (43.2 mm x 21.1 mm x 65.3 mm)	
PDA20C/M		Three M4 Taps		43.2 mm x 21.1 mm x 65.3 mm (1.70" x 0.83" x 2.57")	
<b>FPD Fixed Gain</b>					
FPD510-FS-NIR, FPD610-FS-NIR		One M4 Tap	N/A	2.36" x 0.79" x 1.97" (60.0 mm x 20.0 mm x 50.0 mm)	SMA
<b>PDA Switchable Gain</b>					
PDA10CS2, PDA20CS2		Two Universal Taps for 8-32 and M4	Internal SM05 (0.535"-40) External SM1 (1.035"-40)	2.07" x 0.89" x 2.79" (52.5 mm x 22.5 mm x 70.9 mm)	BNC
<b>FPD Switchable Gain</b>					
FPD310-FS-NIR		One M4 Tap	N/A	2.36" x 0.79" x 1.97" (60.0 mm x 20.0 mm x 50.0 mm)	SMA

PDA and PDF Series Detectors

**BNC Female 0 - 10 V Output (Photodetector)**

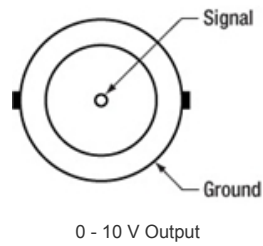

**Male (Power Cables)**

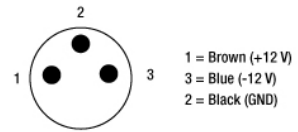

**Female Power IN (Photodetector)**

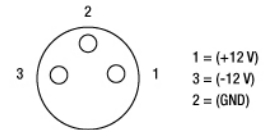

FPD Series Detectors

**Signal Out- SMA Female (Photodetector)**

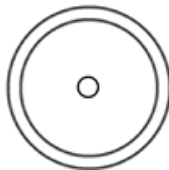

For connection to a suitable monitoring device, e.g. oscilloscope or RF-spectrum-analyzer, with 50 Ω impedance.

**Female (Power Cables)**

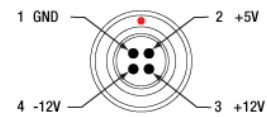

**Male Power IN (Photodetector)**

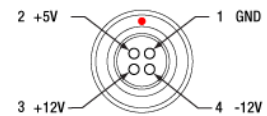

## Photodiode Tutorial

### Theory of Operation

A junction photodiode is an intrinsic device that behaves similarly to an ordinary signal diode, but it generates a photocurrent when light is absorbed in the depleted region of the junction semiconductor. A photodiode is a fast, highly linear device that exhibits high quantum efficiency based upon the application and may be used in a variety of different applications.

It is necessary to be able to correctly determine the level of the output current to expect and the responsivity based upon the incident light. Depicted in Figure 1 is a junction photodiode model with basic discrete components to help visualize the main characteristics and gain a better understanding of the operation of Thorlabs' photodiodes.

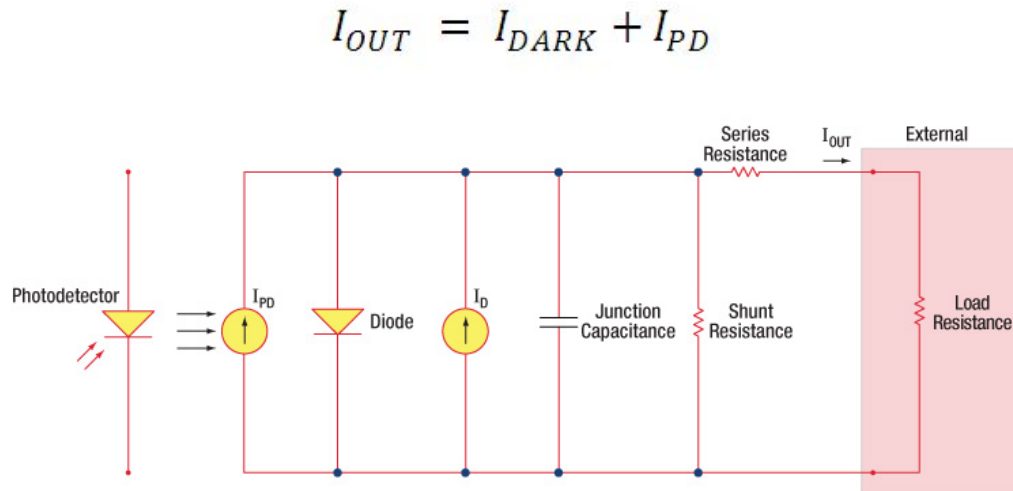

Figure 1: Photodiode Model

### Photodiode Terminology

#### Responsivity

The responsivity of a photodiode can be defined as a ratio of generated photocurrent ( $I_{PD}$ ) to the incident light power ( $P$ ) at a given wavelength:

$$R(\lambda) = \frac{I_{PD}}{P}$$

#### Modes of Operation (Photoconductive vs. Photovoltaic)

A photodiode can be operated in one of two modes: photoconductive (reverse bias) or photovoltaic (zero-bias). Mode selection depends upon the application's speed requirements and the amount of tolerable dark current (leakage current).

##### Photoconductive

In photoconductive mode, an external reverse bias is applied, which is the basis for our DET series detectors. The current measured through the circuit indicates illumination of the device; the measured output current is linearly proportional to the input optical power. Applying a reverse bias increases the width of the depletion junction producing an increased responsivity with a decrease in junction capacitance and produces a very linear response. Operating under these conditions does tend to produce a larger dark current, but this can be limited based upon the photodiode material. (Note: Our DET detectors are reverse biased and cannot be operated under a forward bias.)

##### Photovoltaic

In photovoltaic mode the photodiode is zero biased. The flow of current out of the device is restricted and a voltage builds up. This mode of operation exploits the photovoltaic effect, which is the basis for solar cells. The amount of dark current is kept at a minimum when operating in photovoltaic mode.

##### Dark Current

Dark current is leakage current that flows when a bias voltage is applied to a photodiode. When operating in a photoconductive mode, there tends to be a higher dark current that varies directly with temperature. Dark current approximately doubles for every 10 °C increase in temperature, and shunt resistance tends to double for every 6 °C rise. Of course, applying a higher bias will decrease the junction capacitance but will increase the amount of dark current present.

The dark current present is also affected by the photodiode material and the size of the active area. Silicon devices generally produce low dark current compared to germanium devices which have high dark currents. The table below lists several photodiode materials and their relative dark currents, speeds, sensitivity, and costs.



Material	Dark Current	Speed	Spectral Range	Cost
Silicon (Si)	Low	High Speed	Visible to NIR	Low
Germanium (Ge)	High	Low Speed	NIR	Low
Gallium Phosphide (GaP)	Low	High Speed	UV to Visible	Moderate
Indium Gallium Arsenide (InGaAs)	Low	High Speed	NIR	Moderate
Indium Arsenide Antimonide (InAsSb)	High	Low Speed	NIR to MIR	High
Extended Range Indium Gallium Arsenide (InGaAs)	High	High Speed	NIR	High
Mercury Cadmium Telluride (MCT, HgCdTe)	High	Low Speed	NIR to MIR	High

#### Junction Capacitance

Junction capacitance ( $C_j$ ) is an important property of a photodiode as this can have a profound impact on the photodiode's bandwidth and response. It should be noted that larger diode areas encompass a greater junction volume with increased charge capacity. In a reverse bias application, the depletion width of the junction is increased, thus effectively reducing the junction capacitance and increasing the response speed.

#### Bandwidth and Response

A load resistor will react with the photodetector junction capacitance to limit the bandwidth. For best frequency response, a 50  $\Omega$  terminator should be used in conjunction with a 50  $\Omega$  coaxial cable. The bandwidth ( $f_{BW}$ ) and the rise time response ( $t_r$ ) can be approximated using the junction capacitance ( $C_j$ ) and the load resistance ( $R_{LOAD}$ ):

$$f_{BW} = 1 / (2 * \pi * R_{LOAD} * C_j)$$

$$t_r = 0.35 / f_{BW}$$

#### Noise Equivalent Power

The noise equivalent power (NEP) is the generated RMS signal voltage generated when the signal to noise ratio is equal to one. This is useful, as the NEP determines the ability of the detector to detect low level light. In general, the NEP increases with the active area of the detector and is given by the following equation:

$$NEP = \frac{\text{Incident Energy} * \text{Area}}{\frac{S}{N} * \sqrt{\Delta f}}$$

Here, S/N is the Signal to Noise Ratio,  $\Delta f$  is the Noise Bandwidth, and Incident Energy has units of  $W/cm^2$ . For more information on NEP, please see Thorlabs' Noise Equivalent Power White Paper.

#### Terminating Resistance

A load resistance is used to convert the generated photocurrent into a voltage ( $V_{OUT}$ ) for viewing on an oscilloscope:

$$V_{OUT} = I_{OUT} * R_{LOAD}$$

Depending on the type of the photodiode, load resistance can affect the response speed. For maximum bandwidth, we recommend using a 50  $\Omega$  coaxial cable with a 50  $\Omega$  terminating resistor at the opposite end of the cable. This will minimize ringing by matching the cable with its characteristic impedance. If bandwidth is not important, you may increase the amount of voltage for a given light level by increasing  $R_{LOAD}$ . In an unmatched termination, the length of the coaxial cable can have a profound impact on the response, so it is recommended to keep the cable as short as possible.

#### Shunt Resistance

Shunt resistance represents the resistance of the zero-biased photodiode junction. An ideal photodiode will have an infinite shunt resistance, but actual values may range from the order of ten  $\Omega$  to thousands of  $M\Omega$  and is dependent on the photodiode material. For example, an InGaAs detector has a shunt resistance on the order of 10  $M\Omega$  while a Ge detector is in the  $k\Omega$  range. This can significantly impact the noise current on the photodiode. For most applications, however, the high resistance produces little effect and can be ignored.

#### Series Resistance

Series resistance is the resistance of the semiconductor material, and this low resistance can generally be ignored. The series resistance arises from the contacts and the wire bonds of the photodiode and is used to mainly determine the linearity of the photodiode under zero bias conditions.

## Common Operating Circuits

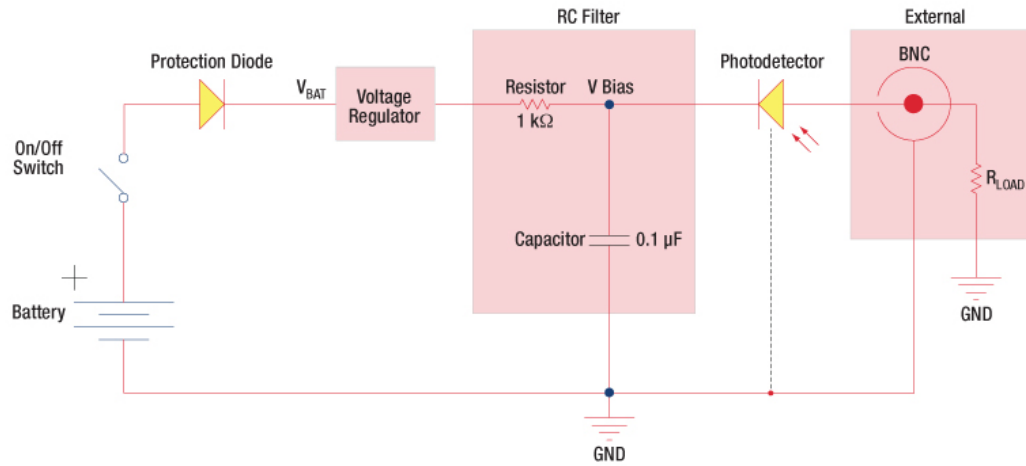

Figure 2: Reverse-Biased Circuit (DET Series Detectors)

The DET series detectors are modeled with the circuit depicted above. The detector is reverse biased to produce a linear response to the applied input light. The amount of photocurrent generated is based upon the incident light and wavelength and can be viewed on an oscilloscope by attaching a load resistance on the output. The function of the RC filter is to filter any high-frequency noise from the input supply that may contribute to a noisy output.

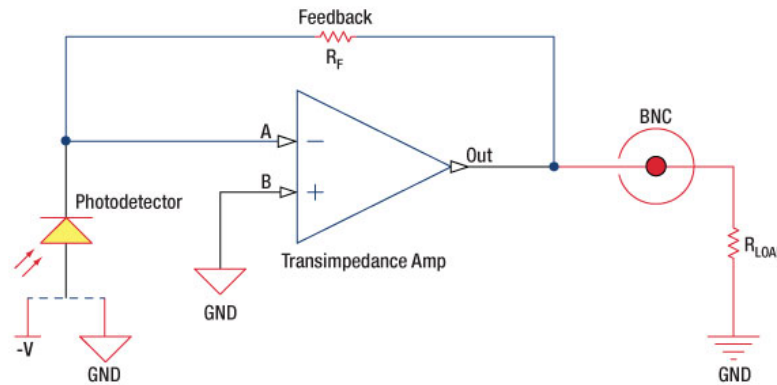

Figure 3: Amplified Detector Circuit

One can also use a photodiode with an amplifier for the purpose of achieving high gain. The user can choose whether to operate in Photovoltaic or Photoconductive modes. There are a few benefits of choosing this active circuit:

- Photovoltaic mode: The circuit is held at zero volts across the photodiode, since point A is held at the same potential as point B by the operational amplifier. This eliminates the possibility of dark current.
- Photoconductive mode: The photodiode is reverse biased, thus improving the bandwidth while lowering the junction capacitance. The gain of the detector is dependent on the feedback element ( $R_f$ ). The bandwidth of the detector can be calculated using the following:

$$f(-3dB) = \sqrt{\frac{GBP}{4\pi * R_f * C_D}}$$

where GBP is the amplifier gain bandwidth product and  $C_D$  is the sum of the junction capacitance and amplifier capacitance.

### Effects of Chopping Frequency

The photoconductor signal will remain constant up to the time constant response limit. Many detectors, including PbS, PbSe, HgCdTe (MCT), and InAsSb, have a typical 1/f noise spectrum (i.e., the noise decreases as chopping frequency increases), which has a profound impact on the time constant at lower frequencies.

The detector will exhibit lower responsivity at lower chopping frequencies. Frequency response and detectivity are maximized for

$$f_c = \frac{1}{2\pi\tau_r}$$

PREVIOUS GENERATION & NBSP ;

The following table lists Thorlab's selection of previous and current generation PDA and DET detectors.

Previous Generation Cross Reference of PDA and DET Detectors					
Wavelength	Material	Biased Detector		Amplified Detector	
		Current Generation	Previous Generation	Current Generation	Previous Generation
150 - 550 nm	GaP	DET25K2	DET25K(/M)	PDA25K2	PDA25K(-EC)
200 - 1100 nm	Si	DET10A2	DET10A(/M)	PDA10A2	PDA10A(-EC)
320 - 1100 nm	Si	DET100A2	DET100A(/M) <sup>a</sup>	PDA100A2	PDA100A(-EC) <sup>b</sup>
350 - 1100 nm	Si	DET36A2	DET36A(/M)	PDA36A2	PDA36A(-EC)
500 - 1700 nm	InGaAs	DET10N2	DET10N(/M)	-	-
800 - 1700 nm	InGaAs	DET20C2	DET20C(/M)	PDA20CS2	PDA20CS(-EC)
		-	-	PDA05CF2	PDA10CF(-EC)
800 - 1800 nm	Ge	DET30B2	DET30B(/M)	PDA30B2	PDA30B(-EC)
		DET50B2	DET50B(/M)	PDA50B2	PDA50B(-EC)
900 - 1700 nm	InGaAs	DET10C2	DET10C(/M)	PDA10CS2	PDA10CS(-EC)
900 - 2600 nm	InGaAs	DET05D2	DET05D(/M) <sup>c</sup>	PDA10D2	PDA10D(-EC) <sup>c</sup>
		DET10D2	DET10D(/M) <sup>c</sup>	-	-

a.

b.

c.

The DET100A(/M) wavelength range is 350 - 1100 nm.  
 The PDA100A(-EC) wavelength range is 340 - 1100 nm.  
 The DET05D(/M), PDA10D(-EC), and DET10D(/M) wavelength range is 800 - 2600 nm.

The following table lists Thorlabs' selection of photodiodes and photoconductive detectors. Item numbers in the same row contain the same detector element.

Photodetector Cross Reference						
Wavelength	Material	Unmounted Photodiode	Unmounted Photoconductor	Mounted Photodiode	Biased Detector	Amplified Detector
150 - 550 nm	GaP	FGAP71	-	SM05PD7A	DET25K2	PDA25K2
200 - 1100 nm	Si	FDS010	-	SM05PD2A SM05PD2B	DET10A2	PDA10A2
	Si	-	-	SM1PD2A	-	-
320 - 1000 nm	Si	-	-	-	-	PDA8A(/M)
320 - 1100 nm	Si	FD11A	-	SM05PD3A	-	PDF10A(/M)
	Si	-	-	-	DET100A2	PDA100A2
340 - 1100 nm	Si	FDS10X10	-	-	-	-
350 - 1100 nm	Si	FDS100 FDS100-CAL <sup>a</sup>	-	SM05PD1A SM05PD1B	DET36A2	PDA36A2
	Si	FDS1010 FDS1010-CAL <sup>a</sup>	-	SM1PD1A SM1PD1B	-	-
400 - 1000 nm	Si	-	-	-	-	PDA015A(/M) FPD310-FS-VIS FPD310-FC-VIS FPD510-FC-VIS FPD510-FS-VIS FPD610-FC-VIS FPD610-FS-VIS
400 - 1100 nm	Si	FDS015 <sup>b</sup>	-	-	-	-
	Si	FDS025 <sup>b</sup> FDS02 <sup>c</sup>	-	-	DET02AFC(/M) DET025AFC(/M) DET025A(/M) DET025AL(/M)	-
400 - 1700 nm	Si & InGaAs	DSD2	-	-	-	-
500 - 1700 nm	InGaAs	-	-	-	DET10N2	-
750 - 1650 nm	InGaAs	-	-	-	-	PDA8GS
800 - 1700 nm	InGaAs	FGA015	-	-	-	PDA015C(/M)
	InGaAs	FGA21 FGA21-CAL <sup>a</sup>	-	SM05PD5A	DET20C2	PDA20C/M PDA20CS2
	InGaAs	FGA01 <sup>b</sup> FGA01FC <sup>c</sup>	-	-	DET01CFC(/M)	-
	InGaAs	FDGA05 <sup>b</sup>	-	-	-	PDA05CF2
	InGaAs	-	-	-	DET08CFC(/M) DET08C(/M) DET08CL(/M)	PDF10C(/M)
800 - 1800 nm	Ge	FDG03 FDG03-CAL <sup>a</sup>	-	SM05PD6A	DET30B2	PDA30B2
	Ge	FDG50	-	-	DET50B2	PDA50B2
	Ge	FDG05	-	-	-	-
900 - 1700 nm	InGaAs	FGA10	-	SM05PD4A	DET10C2	PDA10CS2
900 - 2600 nm	InGaAs	FD05D	-	-	DET05D2	-
		FD10D	-	-	DET10D2	PDA10D2
950 - 1650 nm	InGaAs	-	-	-	-	FPD310-FC-NIR FPD310-FS-NIR FPD510-FC-NIR FPD510-FS-NIR FPD610-FC-NIR FPD610-FS-NIR
1.0 - 2.9 $\mu$ m	PbS	-	FDPS3X3	-	-	PDA30G(-EC)
1.0 - 5.8 $\mu$ m	InAsSb	-	-	-	-	PDA10PT(-EC)
1.5 - 4.8 $\mu$ m	PbSe	-	FDPSE2X2	-	-	PDA20H(-EC)
2.0 - 5.4 $\mu$ m	HgCdTe (MCT)	-	-	-	-	PDA10JT(-EC)















**Photodetector Cross Reference**

Wavelength	Material	Unmounted Photodiode	Unmounted Photoconductor	Mounted Photodiode	Biased Detector	Amplified Detector
2.0 - 8.0 μm	HgCdTe (MCT)	VML8T0 VML8T4 <sup>d</sup>	-	-	-	PDAVJ8
2.0 - 10.6 μm	HgCdTe (MCT)	VML10T0 VML10T4 <sup>d</sup>	-	-	-	PDAVJ10
2.7 - 5.0 μm	HgCdTe (MCT)	VL5T0	-	-	-	PDAVJ5
2.7 - 5.3 μm	InAsSb	-	-	-	-	PDA07P2

- a.
- b.
- c.
- d.

Calibrated Unmounted Photodiode  
 Unmounted TO-46 Can Photodiode  
 Unmounted TO-46 Can Photodiode with FC/PC Bulkhead  
 Photovoltaic Detector with Thermoelectric Cooler







**InGaAs Amplified Photodetectors, Fixed Gain**

Item # <sup>a</sup>	Housing Features <sup>b</sup>	Wavelength Range	Bandwidth Range	Rise Time	Gain		NEP	Typical Performance Graphs	Active Area <sup>c</sup>	Operating Temperature Range
					Hi-Z Load	50 Ω Load				
PDA015C/M		800 - 1700 nm	DC - 380 MHz	1.0 ns	50 kV/A	25 kV/A	20 pW/Hz <sup>1/2</sup>		0.018 mm <sup>2</sup> (Ø150 μm)	10 to 40 °C
PDA05CF2		800 - 1700 nm	DC - 150 MHz	2.3 ns	10 kV/A	5 kV/A	12.6 pW/Hz <sup>1/2</sup>		0.2 mm <sup>2</sup> (Ø0.5 mm) <sup>d</sup>	10 to 50 °C
PDF10C/M		800 - 1700 nm	DC - 25 Hz	19 ms	1 x 10 <sup>8</sup> kV/A	-	7.5 x 10 <sup>-3</sup> pW/Hz <sup>1/2</sup>		0.2 mm <sup>2</sup> (Ø0.5 mm)	18 to 28 °C
PDA20C/M		800 - 1700 nm	DC - 5 MHz	70 ns	500 kV/A	175 kV/A	22 pW/Hz <sup>1/2</sup>		3.14 mm <sup>2</sup> (Ø2.0 mm)	10 to 50 °C
PDA10D2		900 - 2600 nm	DC - 25 MHz	15 ns	10 kV/A	5 kV/A	10.1 pW/Hz <sup>1/2</sup>		0.8 mm <sup>2</sup> (Ø1.0 mm) <sup>d</sup>	10 to 50 °C
FPD510-FS-NIR		950 - 1650 nm	DC - 250 MHz	2 ns	-	1.5 x 10 <sup>5</sup> V/W	3.2 pW/Hz <sup>1/2</sup>		0.07 mm <sup>2</sup> (Ø0.3 mm)	10 to 40 °C
FPD610-FS-NIR		950 - 1650 nm	DC - 600 MHz	1 ns	-	2 x 10 <sup>6</sup> V/W	6.6 pW/Hz <sup>1/2</sup>		5 x 10 <sup>-3</sup> mm <sup>2</sup> (Ø0.08 mm)	10 to 40 °C

- a. Click on the links to view photos of the items.
- b. Click the icons for details of the housing.
- c. Click on the links to view an image of the detector element.
- d. The detector active area surface is flush with the front of the housing.

Part Number	Description	Price	Availability
PDA015C/M	InGaAs Fixed Gain Amplified Detector, 800 - 1700 nm, 380 MHz BW, 0.018 mm <sup>2</sup> , M4 Mounting Holes	\$1,014.55	Today
PDF10C/M	InGaAs fW Sensitivity Fixed Gain Amplified Detector, 800 - 1700 nm, 25 Hz, 0.2 mm <sup>2</sup> , M4 Mounting Holes	\$889.86	Today
PDA20C/M	Customer Inspired! InGaAs Fixed Gain Amplified Detector, 800 - 1700 nm, 5 MHz BW, 3.14 mm <sup>2</sup> , M4 Mounting Holes	\$611.45	Today
FPD510-FS-NIR	InGaAs Fixed Gain, High-Sensitivity PIN Amplified Detector, 950 - 1650 nm, DC - 250 MHz, 0.07 mm <sup>2</sup> , M4 Mounting Hole	\$1,870.19	Today
FPD610-FS-NIR	InGaAs Fixed Gain, High-Sensitivity PIN Amplified Detector, 950 - 1650 nm, DC - 600 MHz, 0.005 mm <sup>2</sup> , M4 Mounting Hole	\$1,870.19	Today
PDA05CF2	InGaAs Fixed Gain Amplified Detector, 800 - 1700 nm, 150 MHz BW, 0.2 mm <sup>2</sup> , Universal 8-32 / M4 Mounting Holes	\$421.29	Today
PDA10D2	InGaAs Fixed Gain Amplified Detector, 900 - 2600 nm, 25 MHz BW, 0.8 mm <sup>2</sup> , Universal 8-32 / M4 Mounting Holes	\$551.57	Today
PDA015C	InGaAs Fixed Gain Amplified Detector, 800 - 1700 nm, 380 MHz BW, 0.018 mm <sup>2</sup> , 8-32 Mounting Holes	\$1,014.55	Today
PDF10C	InGaAs fW Sensitivity Fixed Gain Amplified Detector, 800 - 1700 nm, 25 Hz, 0.2 mm <sup>2</sup> , 8-32 Mounting Holes	\$889.86	Today

## InGaAs Amplified Photodetector, Switchable Gain

Item # <sup>a</sup>	Housing Features <sup>b</sup>	Wavelength Range	Bandwidth Range	Gain <sup>c</sup>		NEP	Typical Performance Graphs	ActiveArea <sup>d</sup>	Operating Temperature Range	Power Supply Included
				Hi-Z Load	50 Ω Load					
PDA20CS2		800 - 1700 nm	DC - 11 MHz	1.51 kV/A - 4.75 MV/A	0.75 kVA - 2.38 MV/A	1.95 - 61 pW/Hz <sup>1/2</sup>		3.14 mm <sup>2</sup> (Ø2.0 mm) <sup>e</sup>	10 to 40 °C	Yes
PDA10CS2		900 - 1700 nm	DC - 13 MHz	1.51 kV/A - 4.75 MV/A	0.75 kVA - 2.38 MV/A	1.91 - 46 pW/Hz <sup>1/2</sup>		0.8 mm <sup>2</sup> (Ø1.0 mm) <sup>e</sup>	10 to 40 °C	Yes
FPD310-FS-NIR		950 - 1650 nm	1 MHz - 1.5 GHz	-	2 x 10 <sup>3</sup> - 2 x 10 <sup>4</sup> V <sub>pp</sub> /W	14.1 pW/Hz <sup>1/2</sup>		5 x 10 <sup>-3</sup> mm <sup>2</sup> (Ø0.08 mm)	10 to 40 °C	Yes

- a. Click on the Item #'s to view an image of the detector.
- b. Click the icons for details of the housing.
- c. For complete Gain Specifications, see the Specs tab.
- d. Click on the links to view an image of the detector element.
- e. The detector active area surface is flush with the front of the housing.

Part Number	Description	Price	Availability
FPD310-FS-NIR	InGaAs Switchable Gain, High Sensitivity PIN Amplified Detector, 950 - 1650 nm, 1 MHz - 1.5 GHz BW, 0.005 mm <sup>2</sup> , M4 Mounting Hole	\$1,870.19	Today
PDA20CS2	InGaAs Switchable Gain Amplified Detector, 800 - 1700 nm, 11 MHz BW, 3.14 mm <sup>2</sup> , Universal 8-32 / M4 Mounting Holes	\$558.92	Today
PDA10CS2	InGaAs Switchable Gain Amplified Detector, 900 - 1700 nm, 13 MHz BW, 0.8 mm <sup>2</sup> , Universal 8-32 / M4 Mounting Holes	\$421.29	Today

### PDA Power Supply Cable

The PDA-C-72 power cord is offered for the PDA line of amplified photodetectors when using with a power supply other than the one included with the detector. The cord has tinned leads on one end and a PDA-compatible 3-pin connector on the other end. It can be used to power the PDA series of amplified photodetectors with any power supply that provides a DC voltage. The pin descriptions are shown to the right.

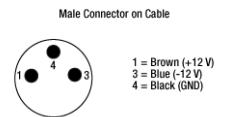

Part Number	Description	Price	Availability
PDA-C-72	72" PDA Power Supply Cable, 3-Pin Connector	\$20.49	Today

### ±12 VDC Regulated Linear Power Supply

- Replacement Power Supply for the PDA and PDF Amplified Photodetectors Sold Above
- ±12 VDC Power Output
- Current Limit Enabling Short Circuit and Overload Protection
- On/Off Switch with LED Indicator
- Switchable AC Input Voltage (100, 120, or 230 VAC)
- 2 m (6.6 ft) Cable with LUMBERG RSMV3 Male Connector
- UL and CE Compliant

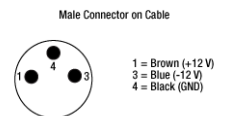





The LDS12B ±12 VDC Regulated Linear Power Supply is intended as a replacement for the supply that comes with our PDA and PDF line of amplified photodetectors sold on this page. The cord has three pins: one for ground, one for +12 V, and one for -12 V (see diagram above). A region-specific power cord is shipped with the LDS12B power supply based on your location. This power supply can also be used with the PDB series of balanced photodetectors, PMM series of photomultiplier modules, APD series of avalanche photodetectors, and the FSAC autocorrelator for femtosecond lasers.

Part Number	Description	Price	Availability
LDS12B	±12 VDC Regulated Linear Power Supply, 6 W, 100/120/230 VAC	\$82.74	Today

## Internally SM1-Threaded Fiber Adapters

These internally SM1-threaded (1.035"-40) adapters mate terminated fiber to any of our externally SM1-threaded components, including our photodiode power sensors, our thermal power sensors, and our photodetectors. These adapters are compatible with the housing of the photodetectors on this page.

The APC adapter has two dimples in the front surface that allow it to be tightened with the SPW909 or SPW801 spanner wrench. The dimples do not go all the way through the disk so that the adapter can be used in light-tight applications when paired with SM1 lens tubes.

Item #	S120-APC <sup>a</sup>	S120-SMA	S120-ST	S120-SC	S120-LC
Adapter Image (Click the Image to Enlarge)					
Fiber Connector Type <sup>b</sup>	FC/APC <sup>c</sup>	SMA	ST	SC	LC
Thread	Internal SM1 (1.035"-40)				

a. The S120-APC is designed with a 4° mechanical angle to compensate for the refraction angle of the output beam.

b. Other Connector Types Available upon Request

c. This connector uses a wide key (2.2 mm).







Part Number	Description	Price	Availability
S120-APC	NEW! Customer Inspired! FC/APC Fiber Adapter Cap with Internal SM1 (1.035"-40) Threads	\$32.00	Lead Time
S120-SMA	SMA Fiber Adapter Cap with Internal SM1 (1.035"-40) Threads	\$40.97	Today
S120-ST	ST/PC Fiber Adapter Cap with Internal SM1 (1.035"-40) Threads	\$40.97	Today
S120-SC	SC/PC Fiber Adapter Cap with Internal SM1 (1.035"-40) Threads	\$51.48	Today
S120-LC	LC/PC Fiber Adapter Cap with Internal SM1 (1.035"-40) Threads	\$51.48	Today

## Externally SM1-Threaded Fiber Adapters

- Externally SM1-Threaded (1.035"-40) Disks with FC/PC, FC/APC, SMA, ST/PC, SC/PC, or LC/PC Receptacle
- Light-Tight When Used with SM1 Lens Tubes
- Compatible with Many of Our 30 mm Cage Plates and Photodetectors

Each disk has four dimples, two in the front surface and two in the back surface, that allow it to be tightened from either side with the SPW909 or SPW801 spanner wrench. The dimples do not go all the way through the disk so that the adapters can be used in light-tight applications when paired with SM1 lens tubes. Once the

adapter is at the desired position, use an SM1RR retaining ring to secure it in place.

Item #	SM1FC	SM1FCA <sup>a</sup>	SM1SMA	SM1ST	SM1SC1	SM1LC
Adapter Image (Click the Image to Enlarge)						
Connector Type	FC/PC	FC/APC <sup>b</sup>	SMA	ST/PC	SC/PC	LC/PC
Threading	External SM1 (1.035"-40)					

a. The SM1FCA is designed with a 4° mechanical angle to compensate for the refraction angle of the output beam.

b. This connector uses a wide key (2.2 mm).

Part Number	Description	Price	Availability
SM1FC	FC/PC Fiber Adapter Plate with External SM1 (1.035"-40) Threads	\$30.47	Today
SM1FCA	FC/APC Fiber Adapter Plate with External SM1 (1.035"-40) Threads	\$32.31	Today
SM1SMA	SMA Fiber Adapter Plate with External SM1 (1.035"-40) Threads	\$30.47	Today
SM1ST	ST/PC Fiber Adapter Plate with External SM1 (1.035"-40) Threads	\$28.33	Today
SM1SC1	NEW! SC/PC Fiber Adapter Plate with External SM1 (1.035"-40) Threads	\$58.00	Today
SM1LC	NEW! LC/PC Fiber Adapter Plate with External SM1 (1.035"-40) Threads	\$58.00	Today

Responsivity Curve

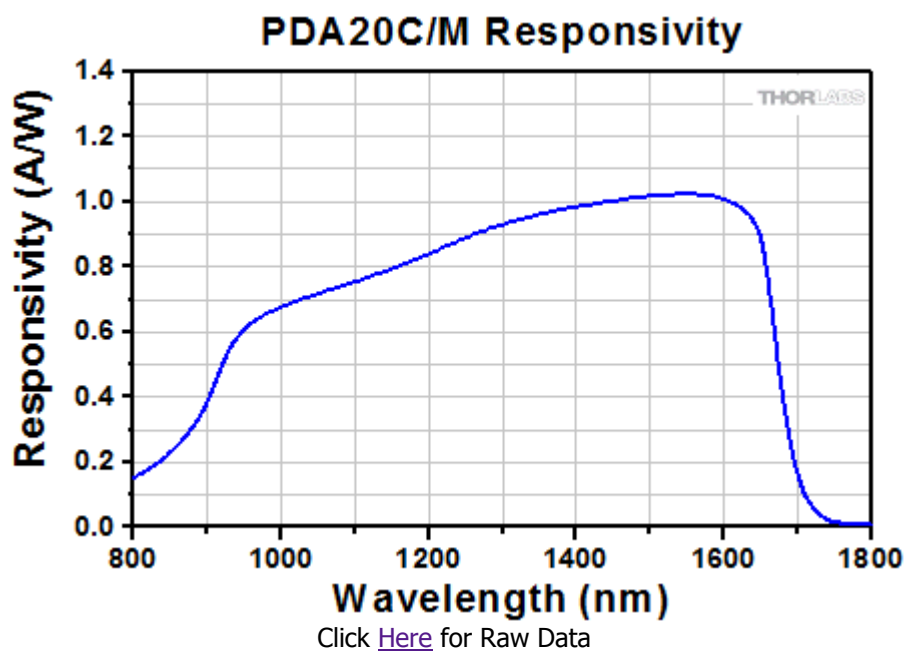





**THORLABS**

[www.thorlabs.com](http://www.thorlabs.com)

**PDF10C/M**

**Femtowatt Photoreceiver**  
800-1700nm

**CE**

OUTPUT  
0-10V

IN

M4