

NOTES:

1. SUBSTRATE:
N-BK7
2. S2 TO BE PARALLEL WITH S1 TO <1 ARCMIN
3. COATING (APPLY ACROSS CLEAR APERTURE)
S1 & S2: RABS ≤0.25% @ 880nm
RAVG ≤1.25% @ 400 - 870nm
RAVG ≤1.25% @ 890 - 1000nm

4. FINE GRIND SURFACE

5. RoHS COMPLIANT

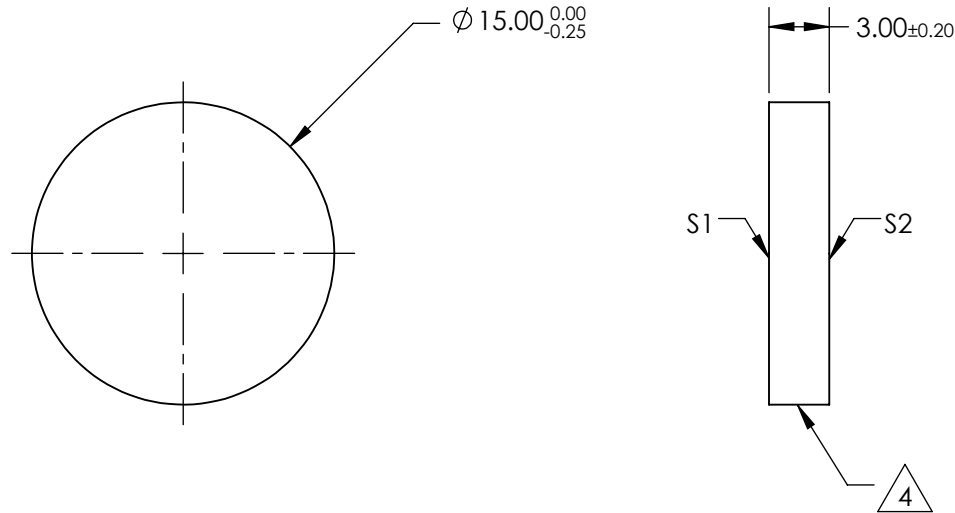
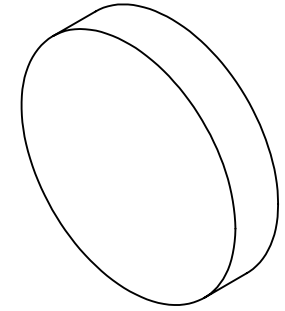

**FOR INFORMATION ONLY:
DO NOT MANUFACTURE
PARTS TO THIS DRAWING**

SPECIFICATIONS SUBJECT TO CHANGE WITHOUT NOTICE
DIMENSIONS ARE FOR REFERENCE ONLY

	S1	S2
SHAPE	PLANO	PLANO
SURFACE QUALITY	60-40	60-40
CLEAR APERTURE	Ø13.50	Ø13.50
BEVEL	PROTECTIVE AS NEEDED	PROTECTIVE AS NEEDED

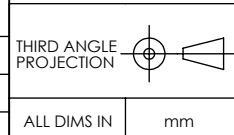

EO® Edmund Optics®

TITLE	15mm DIA., 3mm THICK, VIS-NIR COATED λ/4 N-BK7 WINDOW		
DWG NO	45659	SHEET	1 OF 1