



DET08CFC(/M)

**Fiber Input
InGaAs Biased Detector**

User Guide



















Table of Contents

Chapter 1	Warning Symbol Definitions	1
Chapter 2	Description.....	2
Chapter 3	Setup.....	3
Chapter 4	Operation.....	4
	4.1. Theory of Operation.....	4
	4.2. Responsivity	4
	4.3. Modes of Operation.....	4
	4.3.1. Photoconductive	5
	4.3.2. Photovoltaic	5
	4.4. Dark Current	5
	4.5. Junction Capacitance	6
	4.6. Bandwidth and Response.....	6
	4.7. Terminating Resistance.....	7
	4.8. Shunt Resistance.....	7
	4.9. Series Resistance	7
	4.10. Damage Threshold.....	7
	4.11. Battery Replacement	8
Chapter 5	Common Operating Circuits	9
Chapter 6	Specifications	11
	6.1. Response Curve.....	12
	6.2. Typical Response	12
	6.3. Mechanical Drawing.....	13
Chapter 7	Troubleshooting	14
Chapter 8	Certificate of Conformance	15
Chapter 9	Regulatory.....	16
Chapter 10	Thorlabs Worldwide Contacts.....	17

Chapter 1 Warning Symbol Definitions

Below is a list of warning symbols you may encounter in this manual or on your device.

Symbol	Description
	Direct Current
	Alternating Current
	Both Direct and Alternating Current
	Earth Ground Terminal
	Protective Conductor Terminal
	Frame or Chassis Terminal
	Equipotentiality
	On (Supply)
	Off (Supply)
	In Position of a Bi-Stable Push Control
	Out Position of a Bi-Stable Push Control
	Caution: Risk of Electric Shock
	Caution: Hot Surface
	Caution: Risk of Danger
	Warning: Laser Radiation
	Caution: ESD Sensitive Components

Chapter 2 Description

The DET08CFC(/M) is a ready-to-use, high-speed InGaAs photodetector for use with FC/PC-terminated fiber optic cables in NIR optical systems. This photodetector unit features an FC/PC bulkhead and includes 12 V bias battery, all in a compact aluminum housing. The FC/PC connector provides easy coupling to fiber-based light sources. The output uses an SMA jack to minimize size and maximize frequency response. The maximum bandwidth is 5 GHz and will operate over the spectral range of 800 - 1700 nm. A visible version, the DET025AFC(/M), is also available for operation in the 400 - 1100 nm spectral range.



ESD Caution



The components inside this instrument are ESD sensitive. Take all appropriate precautions to discharge personnel and equipment before making any electrical connections to the unit.

Chapter 3 Setup

The detector can be set up in many different ways using our extensive line of adapters. However, the detector should always be mounted and secured for best operation. Step 1 in the setup instructions below outline how to mount the detector onto a post.

1. Unpack the optical head, install either an imperial or metric optical post into one of the 8-32 (M4 on the /M version) tapped holes located on the bottom and side of the housing, and mount using post holder.
2. Attach a 50 Ω SMA-to-coaxial cable (i.e., Item # CA28xx) to the output of the detector. Select and provide a terminating resistor to the remaining end of the cable. See Chapter 4, page 7, to determine resistor values. Thorlabs sells a 50 Ω terminator (Item # T4119) for best frequency performance and a variable terminator (Item # VT2) for output voltage flexibility. Note the input impedance of your measurement device, since this will act as a terminating resistor. A load resistor is not necessary when using current-measuring devices.

Note: For fastest response, terminate with a 50 Ω load.

3. During alignment, take appropriate precautions, such as using reduced radiation power, or other precautions, and use proper eye and/or skin protection as recommended by the radiation source manufacturer.
4. Apply a light source to the detector.

Chapter 4 Operation

4.1. Theory of Operation

A junction photodiode is an intrinsic device, which behaves similarly to an ordinary signal diode, but it generates a photocurrent when light is absorbed in the depleted region of the junction semiconductor. A photodiode is a fast, linear device that exhibits high quantum efficiency based upon the application used in a variety of different applications.

It is necessary to be able to determine correctly the expected level of the output current and the responsivity based upon the incident light. Depicted in Figure 1 is a junction photodiode model with basic discrete components to help visualize the main characteristics and gain a better understanding of the operation of Thorlabs' photodiodes.

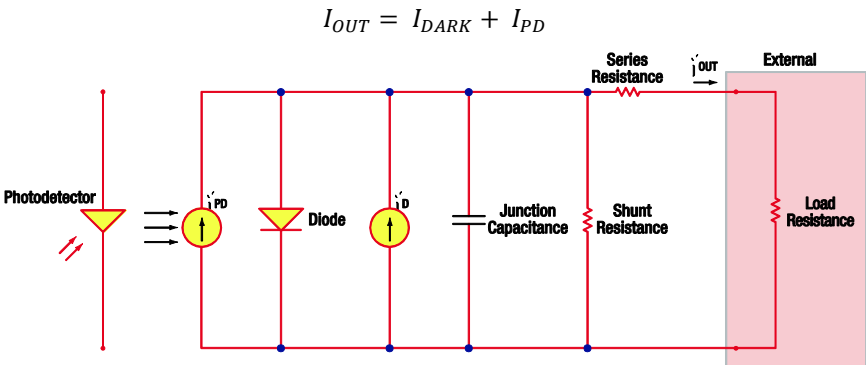

Figure 1 Photodiode Model

4.2. Responsivity

The definition of photodiode responsivity is the ratio of generated photocurrent (I_{PD}) to the incident light power (P) at a given wavelength:

$$R(\lambda) = \frac{I_{PD}}{P}$$

4.3. Modes of Operation

The photodiode can operate in one of two modes: photoconductive (reverse bias) or photovoltaic (zero-bias). Mode selection depends upon the speed requirements of, and the amount of tolerable dark current (leakage current) within, each individual application.

4.3.1. Photoconductive

In photoconductive mode, a reverse external bias is applied, which is the basis for our DET series detectors. The current measured through the circuit indicates illumination of the device; the measured output current is linearly proportional to the input optical power. Applying a reverse bias increases the width of the depletion junction producing an increased responsivity and a decrease in junction capacitance: a linear response. Operating under these conditions tends to produce a larger dark current, but this can be limited by selecting an appropriate photodiode material. **Note: This detector is reverse biased and cannot be operated under a forward bias.**

4.3.2. Photovoltaic

In photovoltaic mode, the photodiode is zero biased. The flow of current out of the device is restricted causing a buildup of voltage. This mode of operation exploits the photovoltaic effect, which is the basis for solar cells. When operating in photovoltaic mode, the amount of dark current is at a minimum setting.

4.4. Dark Current

When a bias voltage is applied to a photodiode, a leakage current, called dark current, is produced. Photoconductive mode tends to generate a higher dark current that varies directly with temperature. Dark current approximately doubles every 10 °C increase in temperature, and shunt resistance doubles every 6 °C rise. Applying a higher bias will decrease the junction capacitance but will also increase the amount of dark current present.

The photodiode material, and the size of the active area, also affect the amount of dark current present. Silicon devices generally produce low dark current compared to germanium devices, which have high dark currents. The table on the next page lists several photodiode materials and their relative dark currents, speeds, sensitivities, and costs.

The table below compares five common types of detector materials.

Material	Dark Current	Speed	Sensitivity ¹ (nm)	Cost
Silicon (Si)	Low	High	400 - 1000	Low
Germanium (Ge)	High	Low	900 - 1600	Low
Gallium Phosphide (GaP)	Low	High	150 - 550	Med
Indium Gallium Arsenide (InGaAs)	Low	High	800 - 1800	Med
Extended Range: Indium Gallium Arsenide (InGaAs)	High	High	1200 - 2600	High

4.5. Junction Capacitance

Junction capacitance (C_J) is an important property of a photodiode as it can have a profound impact on the photodiode's bandwidth and response. It reaffirms that larger diode areas encompass a greater junction volume with increased charge capacity. In a reverse bias application, the depletion width of the junction increases; thus, effectively reducing the junction capacitance and increasing the response speed.

4.6. Bandwidth and Response

A load resistor will react with the photodetector junction capacitance to limit the bandwidth. For best frequency response, a 50Ω terminator should be used in conjunction with a 50Ω coaxial cable. The bandwidth (f_{BW}) and the rise time response (t_r) can be approximated using the junction capacitance (C_J) and the load resistance (R_{LOAD}):

$$f_{BW} = \frac{1}{(2\pi R_{LOAD} \times C_J)}$$

$$t_r = \frac{0.35}{f_{BW}}$$

¹ Approximate values, actual wavelength values will vary from unit to unit.

4.7. Terminating Resistance

A load resistance is used to convert the generated photocurrent into a voltage (V_{OUT}) for viewing on an oscilloscope:

$$V_{OUT} = I_{OUT} \times R_{LOAD}$$

Depending on the type of photodiode, the load resistance can affect the response speed. For maximum bandwidth, we recommend using a 50 Ω coaxial cable with a 50 Ω terminating resistor at the opposite end of the cable. This will minimize ringing by matching the cable with its characteristic impedance. If bandwidth is not important, you may increase the amount of voltage for a given light level by increasing R_{LOAD} . In an unmatched termination, the length of the coaxial cable can have a profound impact on the response; thus, we recommend the cable length to be as short as possible.

4.8. Shunt Resistance

Shunt resistance represents the resistance of the zero-biased photodiode junction. An ideal photodiode has an infinite shunt resistance, but actual values may range from the order of 10 Ω to thousands of $M\Omega$, and is dependent on the photodiode material. For example, an InGaAs detector has a shunt resistance on the order of 10 $M\Omega$ while a Ge detector is in the $k\Omega$ range. This can significantly affect the noise current on the photodiode. For most applications; however, the high resistance produces little effect and can be ignored.

4.9. Series Resistance

Series resistance models the resistance of the semiconductor material. This resistance is typically very low and can be ignored. The series resistance arises from the contacts and the wire bonds of the photodiode. It mainly determines the linearity of the photodiode under zero bias conditions.

4.10. Damage Threshold

Exposure to an intense light source can easily damage a photodiode. One of the main characteristics of a damaged photodiode is the presence of increased dark current, along with burn spots on the detector active area. The damage threshold may vary from photodiode to photodiode, as this is generally dependent on material. Silicon devices tend to be more durable than InGaAs and can handle higher energy levels.

The formula below calculates the energy of each pulse, using the average power and the repetition rate. If the pulse width is given, the peak power can also be determined.

$$Pulse_{Energy} = Average\ Power * T_{pulse}$$

$$Peak\ Power = \frac{Pulse_{Energy}}{Pulse\ Width}$$

4.11. Battery Replacement

Thorlabs delivers each detector with an A23 12 V battery installed. This battery is readily available at most retail stores, as well as through Thorlabs. The supplied battery will deliver about 40 hours of operation with a 1 mA load, which is roughly equivalent to a continuous 1.5 mW light source at peak wavelength. When no light is applied, the supply current is very small and the battery hardly degrades.

Locate the battery cap directly above the output BNC. Unthread the cap and remove the battery. Install the new battery into the cap, negative side in, and thread the cap back into the detector. Be careful not to cross thread the cap into the housing. This detector **does not** include a protection diode to prevent damage if the battery is installed backwards. The correct battery direction is also indicated on the housing.



Chapter 5 Common Operating Circuits

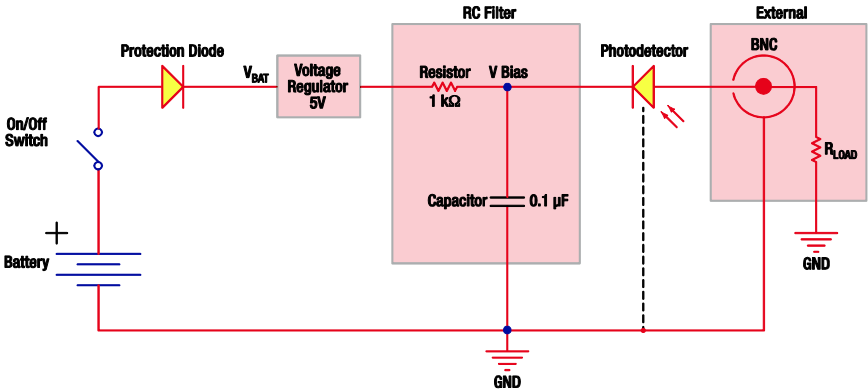

Figure 2 Basic DET Circuit

The DET Series Detectors are designed according to the circuit depicted above. The detector is reverse biased to produce a linear response with applied input light. The generated photocurrent is based upon the incident light and its wavelength and can be viewed on an oscilloscope by attaching a load resistance on the output of the detector. The RC Filter removes all high frequency noise from the input supply, which otherwise may contribute to a noisy output.

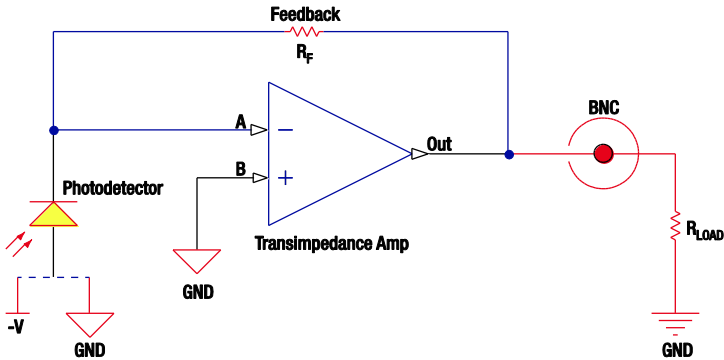

Figure 3 Amplified Detector

One can also use a photodetector with an amplifier for the purpose of achieving high gain. The user can choose whether to operate in Photovoltaic or Photoconductive modes. There are a few benefits of choosing this active circuit:

- **Photovoltaic Mode:** The circuit is maintained at zero volts across the photodiode, holding point A at the same potential as point B by the operational amplifier. This eliminates the possibility of dark current.
- **Photoconductive Mode:** The photodiode is reverse biased improving the bandwidth while lowering the junction capacitance. The gain of the detector is dependent on the feedback element (R_F). The bandwidth of the detector can be calculated using the following equation:

$$f(-3 \text{ dB}) = \sqrt{\frac{GBP}{4\pi R_f \times C_D}}$$

Where GBP is the amplifier product gain-bandwidth and C_D is the sum of the junction capacitance, amplifier capacitance, and feedback capacitance.

Chapter 6 Specifications

All measurements are performed at 25 °C unless stated otherwise.

Electrical Specifications		
Parameter	Symbol	Value
Detector	-	InGaAs PIN
Active Area Diameter	-	Ø80 µm
Wavelength Range	λ	800 to 1700 nm
Peak Wavelength	λ_p	1550 nm
Peak Response ²	$\mathcal{R}(\lambda_p)$	0.90 A/W (Typ.)
Diode Capacitance	C_J	0.3 pF
Bandwidth ^{2,3,4} (-3 dB)	-	5 GHz
Rise Time ^{2,3,4} (20/80%) @ 952 nm	-	70 ps (Typ.)
Fall Time ^{2,3,4} (80/20%) @ 952 nm	-	110 ps (Typ.)
NEP (λ_p) @ 1550 nm	-	$2 \times 10^{-15} \text{ W/Hz}^{1/2}$
Output Voltage ⁵	V_{OUT}	2 V (Max)
After-Pulse Ringing	-	<20% of Maximum
Bias Voltage	V_R	12 V
Dark Current ^{2,6}	I_D	1.5 nA
General		
Input	FC/PC Fiber Connector	
Output	SMA (DC Coupled)	
Package Size	2.21" x 1.40" x 0.80" (56.1 mm x 35.6 mm x 20.3 mm)	
Ball Lens Diameter	0.059" (1.50 mm)	
Ball Lens Clear Aperture	Ø0.8 mm	
Weight	0.18 kg	
Storage Temp	0 to 40 °C	
Operating Temp	0 to 40 °C	
Battery	A23, 12 V _{DC} , 40 mAh	
Replacement Battery	Energizer No. A23	

Bandwidth is defined as the boundary at which the output of the circuit is 3 dB below the nominal output.

² Measured with a specified bias voltage of 12 V.

³ For a 50 Ω Load

⁴ Low battery voltage will result in slower rise times and decreased bandwidth.

⁵ A higher output voltage will decrease the bandwidth.

⁶ For a 1 MΩ Load

6.1. Response Curve

Typical Spectral Response

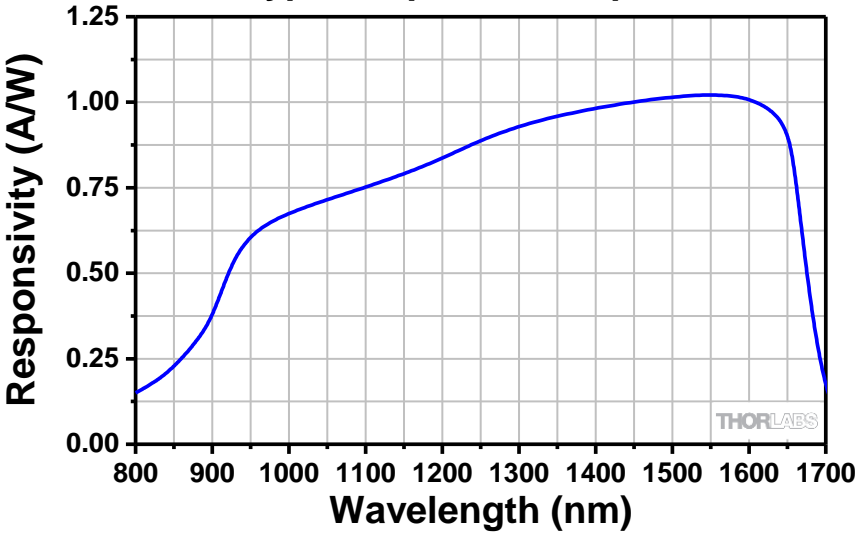

6.2. Typical Response

Typical Pulse Response

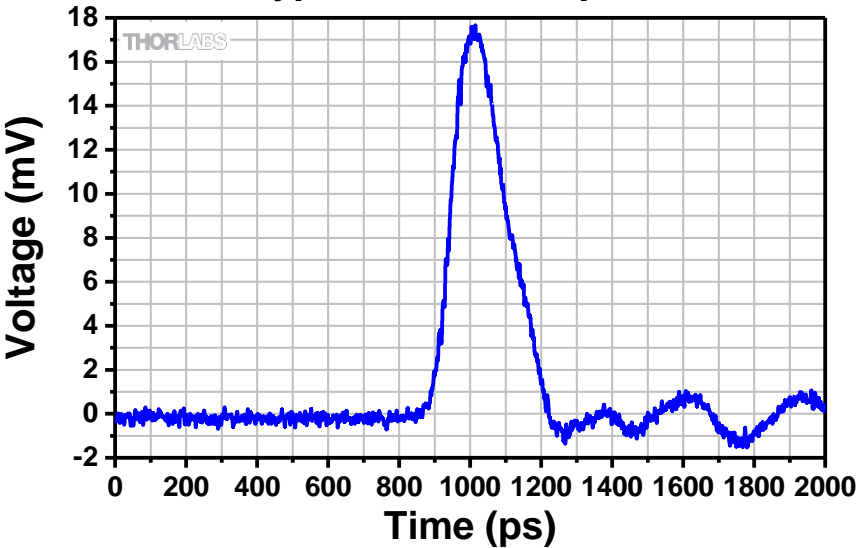

6.3. Mechanical Drawing

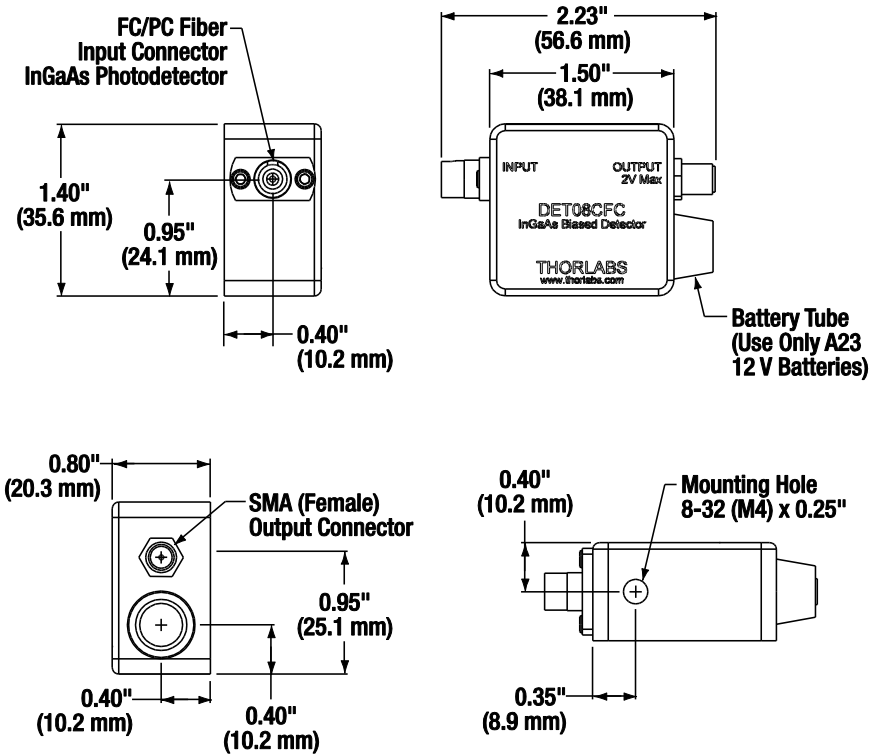

Chapter 7 Troubleshooting

Problem	Suggested Solutions
<p>There is no signal response or response is slower than expected.</p>	<p>Verify that the battery is inserted and has sufficient power (>9 V).</p> <p>Verify the proper terminating resistor is installed if using a Voltage measurement device.</p> <p>Verify that the optical signal wavelength is within the specified wavelength range.</p> <p>Verify that the optical signal is illuminating the detector active area.</p> <p>Connect the detector to an oscilloscope without a terminating resistor installed. Most general purpose oscilloscopes will have a 1 MΩ input impedance. Point the detector toward a fluorescent light and verify that a 60 Hz (50 Hz outside the US) signal appears on the scope. If so the device should be operating properly and the problem may be with the light source or alignment.</p>
<p>There is an AC signal present when the unit is turned off.</p>	<p>The detector has an AC path to ground even with the switch in the OFF position. It is normal to see an output response to an AC signal with the switch in this state. However, because the detector is unbiased, operation in this mode is not recommended.</p>
<p>The output appears AC coupled with long rise times and the power switch ON.</p>	<p>This is usually an indication that the battery level is low and needs to be changed. See Battery Replacement Section for more details.</p>
<p>Skewed Rise and Fall Times</p>	<p>Check to see if the battery voltage is 9 V or greater. Make sure you are not saturating the detector as this can lead to permanent damage.</p>

Chapter 8 Certificate of Conformance



EU Declaration of Conformity

in accordance with EN ISO 17050-1:2010

We: Thorlabs Inc.
 Of: 56 Sparta Avenue, Newton, New Jersey, 07860, USA

in accordance with the following Directive(s):

- 2014/35/EU Low Voltage Directive (LVD)
- 2014/30/EU Electromagnetic Compatibility (EMC) Directive
- 2011/65/EU Restriction of Use of Certain Hazardous Substances (RoHS)

hereby declare that:

Model: PDA10A, PDA8A, PDF10A, PDA36A, PDA100A, PDARA/M, PDF10A/M, PDA36A-EC, PDA10AEC, PDA100A-EC, PDA10CF, PDA10CS, PDF10C, PDA10D, PDA10CF-EC, PDA10CS-EC, PDF10C/M, PDA10D-EC, PDA50B, PDA50B-EC, PDA50G, PDA20H, PDA30G-EC, PDA20H-EC, PDA25K, PDA25K-EC, DET125K, DET125K/M, DET15A, DET15A/M, DET100A, DET100A/M, DET10A/M, DET15A/M, DET150B, DET150B/M, DET120C, DET120C/M, DET150B, DET150B/M, PDA50B, PDA50B-EC, DET10D, DET10D/M, PDA20C, PDA20C/M, PDA20CS-EC, DET101CFC, DET101CFC/M, DET02AFC, DET02AFC/M, DET08CFC, DET08C, DET08CL, DET08CFC/M, DET08C/M, DET08CL/M, DET025AFC, DET025AL, DET025A, DET025AFC/M, DET025AL/M, DET025A/M

Equipment: Fixed and Switchable Gain Detectors

is in conformity with the applicable requirements of the following documents:

EN 61010-1	Safety Requirements for Electrical Equipment for Measurement, Control and Laboratory Use.	2010
EN 61326-1	Electrical Equipment for Measurement, Control and Laboratory Use - EMC Requirements	2013

and which, issued under the sole responsibility of Thorlabs, is in conformity with Directive 2011/65/EU of the European Parliament and of the Council of 8th June 2011 on the restriction of the use of certain hazardous substances in electrical and electronic equipment, for the reason stated below:

does not contain substances in excess of the maximum concentration values tolerated by weight in homogenous materials as listed in Annex II of the Directive

I hereby declare that the equipment named has been designed to comply with the relevant sections of the above referenced specifications, and complies with all applicable Essential Requirements of the Directives.

Signed:  On: 13 January 2017

Name: Ann Strachan
 Position: Compliance Manager EDC - PDA and DET family products -2017...



Chapter 9 Regulatory

As required by the WEEE (Waste Electrical and Electronic Equipment Directive) of the European Community and the corresponding national laws, Thorlabs offers all end users in the EC the possibility to return “end of life” units without incurring disposal charges.

- This offer is valid for Thorlabs electrical and electronic equipment:
- Sold after August 13, 2005
- Marked correspondingly with the crossed out “wheelie bin” logo (see right)
- Sold to a company or institute within the EC
- Currently owned by a company or institute within the EC
- Still complete, not disassembled and not contaminated

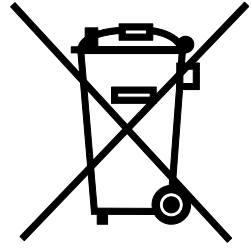

Wheelie Bin Logo

As the WEEE directive applies to self-contained operational electrical and electronic products, this end of life take back service does not refer to other Thorlabs products, such as:

- Pure OEM products, that means assemblies to be built into a unit by the user (e.g. OEM laser driver cards)
- Components
- Mechanics and optics
- Left over parts of units disassembled by the user (PCB's, housings, etc.).

If you wish to return a Thorlabs unit for waste recovery, please contact Thorlabs or your nearest dealer for further information.

Waste Treatment is Your Own Responsibility

If you do not return an “end of life” unit to Thorlabs, you must hand it to a company specialized in waste recovery. Do not dispose of the unit in a litter bin or at a public waste disposal site.

Ecological Background

It is well known that WEEE pollutes the environment by releasing toxic products during decomposition. The aim of the European RoHS directive is to reduce the content of toxic substances in electronic products in the future.

The intent of the WEEE directive is to enforce the recycling of WEEE. A controlled recycling of end of life products will thereby avoid negative impacts on the environment.

Chapter 10 Thorlabs Worldwide Contacts

For technical support or sales inquiries, please visit us at www.thorlabs.com/contact for our most up-to-date contact information.



USA, Canada, and South America

Thorlabs, Inc.
sales@thorlabs.com
techsupport@thorlabs.com

UK and Ireland

Thorlabs Ltd.
sales.uk@thorlabs.com
techsupport.uk@thorlabs.com

Europe

Thorlabs GmbH
europe@thorlabs.com

Scandinavia

Thorlabs Sweden AB
scandinavia@thorlabs.com

France

Thorlabs SAS
sales.fr@thorlabs.com

Brazil

Thorlabs Vendas de Fotônicos Ltda.
brasil@thorlabs.com

Japan

Thorlabs Japan, Inc.
sales@thorlabs.jp

China

Thorlabs China
chinasales@thorlabs.com



THORLABS

www.thorlabs.com
