

NOTES:

1. SUBSTRATE:
SILICON (Si)
2. SURFACE S2 TO BE PARALLEL TO S1 WITHIN <3 ARCMIN
3. COATING (APPLY ACROSS CLEAR APERTURE)
S1 & S2: RAVG <3.0% @ 3 - 5µm

4. FINE GRIND SURFACE

5. RoHS COMPLIANT

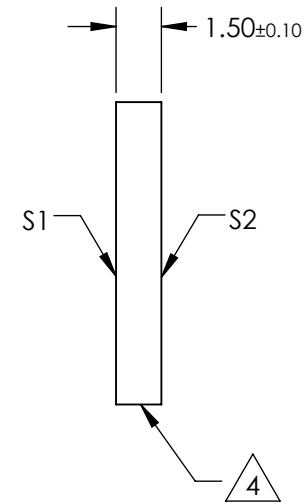
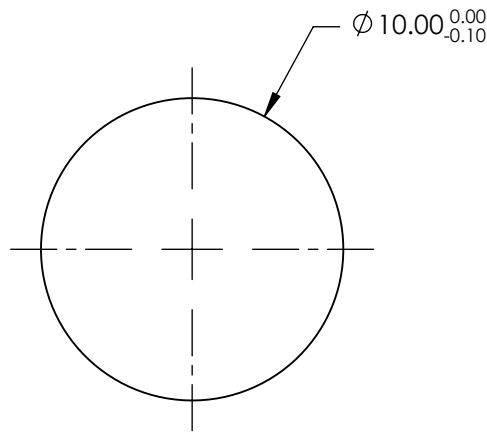
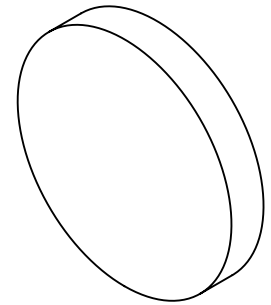

**FOR INFORMATION ONLY:
DO NOT MANUFACTURE
PARTS TO THIS DRAWING**

SPECIFICATIONS SUBJECT TO CHANGE WITHOUT NOTICE
DIMENSIONS ARE FOR REFERENCE ONLY

	S1	S2
SHAPE	PLANO	PLANO
CLEAR APERTURE	90%	90%
SURFACE QUALITY	60-40	60-40
SURFACE FLATNESS	1λ	1λ
BEVEL	PROTECTIVE AS NEEDED	PROTECTIVE AS NEEDED

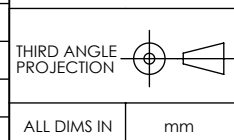

EO® Edmund Optics®

TITLE: 10mm DIA. x 1.5mm THICKNESS 3-5µm COATED SILICON WINDOW

DWG NO: 47940

SHEET 1 OF 1