

NOTES:

1. SUBSTRATE MATERIAL:  
FLOAT GLASS
2. COATING (APPLW ACROSS CLEAR APERTURE):  
S1: BARE ALUMINUM  
S2: NONE
3. BLAZE ANGLE: 2° 34'  
NOMINAL BLAZE WAVELENGTH: 300nm  
EFFICIENCY: 60-80% @ BLAZE WAVELENGTH

4. EDGES GROUND
5. RoHS COMPLIANT

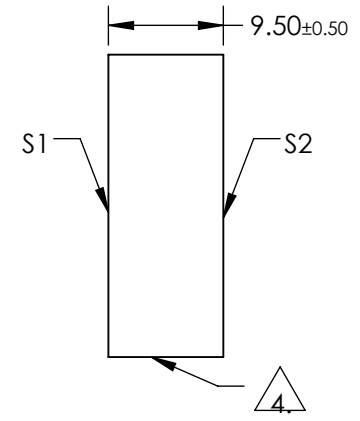
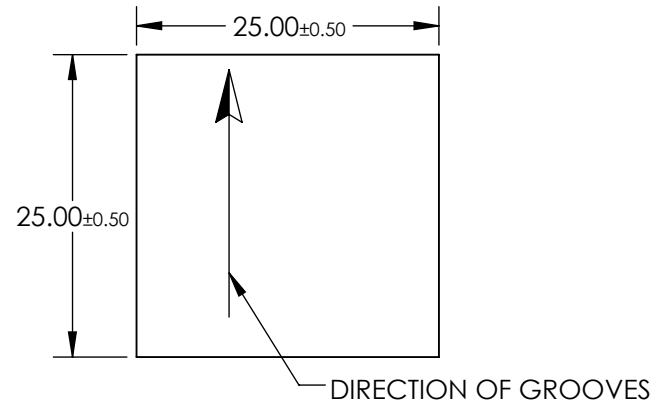
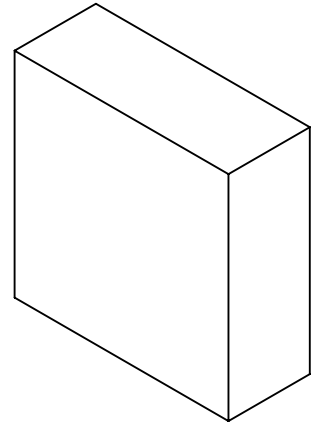

**FOR INFORMATION ONLY:  
DO NOT MANUFACTURE  
PARTS TO THIS DRAWING**

SPECIFICATIONS SUBJECT TO CHANGE WITHOUT NOTICE  
DIMENSIONS ARE FOR REFERENCE ONLY



	S1	S2	THIRD ANGLE PROJECTION		TITLE	GRATING DIFF 300GR 300nm 25 x 25	
SHAPE	PLANO	PLANO	ALL DIMS IN	mm	DWG NO	43738	SHEET 1 OF 1
CLEAR APERTURE	22.5 x 22.5	22.5 x 22.5					