

NOTES:

1. MATERIAL:  
HOUSING: STAINLESS STEEL  
LENS: D-ZLcF52LA
2. COATING (APPLY ACROSS CLEAR APERTURE)  
R(AVG) <0.4% @ 600 - 1050nm
3. CLEAR APERTURE: 5.00 mm
4. RoHS: COMPLIANT

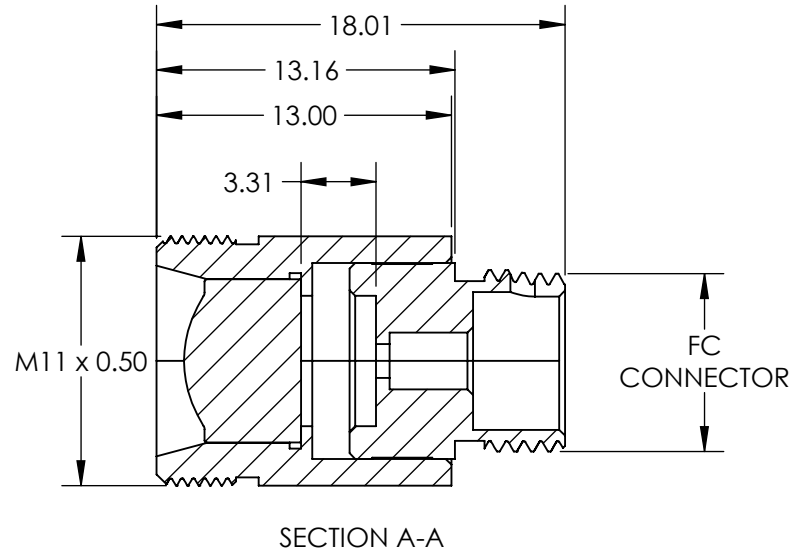
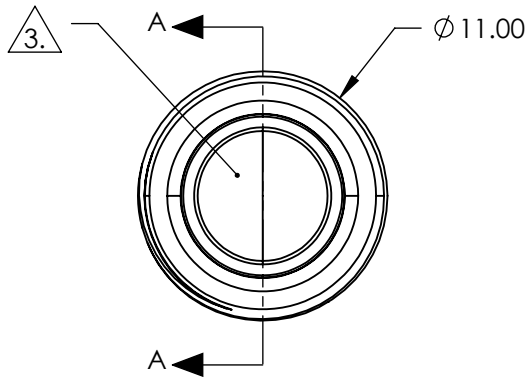
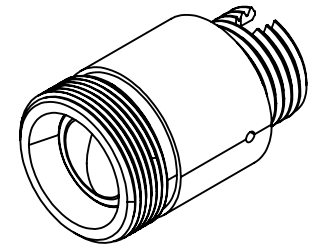

SPECIFICATIONS SUBJECT TO CHANGE WITHOUT NOTICE  
DIMENSIONS ARE FOR REFERENCE ONLY

**EO**® Edmund Optics®

**FOR INFORMATION ONLY:  
DO NOT MANUFACTURE  
PARTS TO THIS DRAWING**

THIRD ANGLE PROJECTION		TITLE	780nm Alignment, 0.40 NA Fiber Collimator w/ FC Connector	
ALL DIMS IN	mm	DWG NO	64771	SHEET 1 OF 1