

# TECHSPEC® RefIX™ OBJECTIVES

#58-421 • 23.75mm WD • 15X/0.28NA  
UV ENHANCED ALUMINUM

Reflective Objectives are commonly used in applications requiring superior image quality or focusing performance over a broad spectral range. The schwarzschild-style objective exhibits near-diffraction limited performance over the full reflecting range of the chosen coating. By eliminating the problems of chromatic aberration and material absorption associated with standard microscope objectives, these components are ideal for applications requiring high throughput and excellent resolution in the UV or IR, including FTIR spectroscopy, ellipsometry, photolithography, and semiconductor inspection.



<b>Style:</b>	Finite Conjugate
<b>Magnification:</b>	15X
<b>Numerical Aperture NA:</b>	0.28
<b>Working Distance (mm):</b>	23.75
<b>Focal Length FL (mm):</b>	13.3
<b>Field of View, 2/3" Sensor:</b>	0.59 x 0.44mm
<b>Field of View, 1/2" Sensor:</b>	0.43 x 0.32mm
<b>Transmitted Wavefront, RMS:</b>	$\lambda/10$
<b>Obscuration (%):</b>	27
<b>Entrance Pupil (mm):</b>	7.4 (Diameter)

<b>Aperture Diameter (mm):</b>	8.5
<b>Diameter of Small Mirror (mm):</b>	8.8
<b>Reflection (%):</b>	0.85
<b>Coating:</b>	UV Enhanced Aluminum
<b>Coating Specification:</b>	$R_{avg} > 85\%$ @ 250 - 700nm
<b>Mounting Threads:</b>	RMS
<b>Type:</b>	Microscope Objective
<b>Wavelength Range (<math>\mu\text{m}</math>):</b>	0.2 - 11
<b>Wavelength Range (nm):</b>	200 - 11000
<b>Manufacturer:</b>	EO

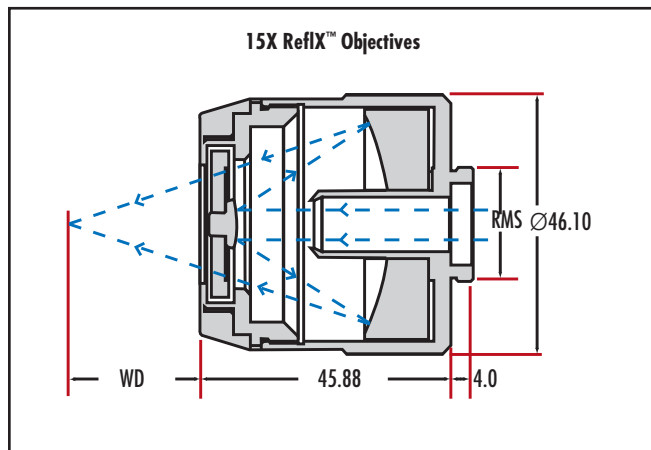

Figure 1: Dimensions of Objective.

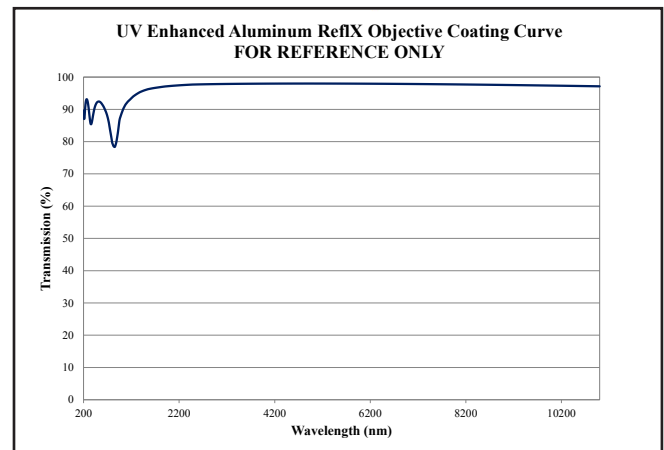

Figure 2: Spectral Reflectance Curve.