

NOTES:

1. SUBSTRATE:  
BOROFLOAT ®
2. COATING (APPLY ACROSS CLEAR APERTURE)  
S1 & S2: UNCOATED
3.  GROUND EDGES
4. ROHS COMPLIANT

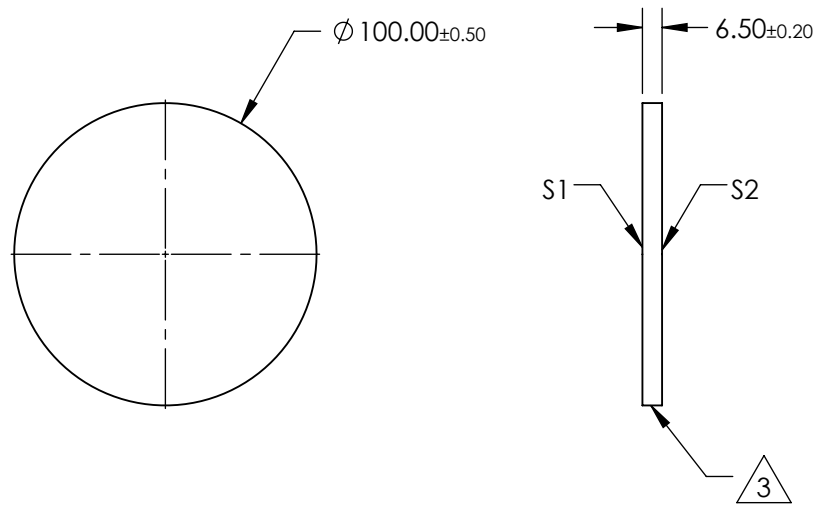
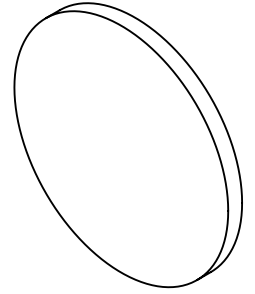

**FOR INFORMATION ONLY:  
DO NOT MANUFACTURE  
PARTS TO THIS DRAWING**

SPECIFICATIONS SUBJECT TO CHANGE WITHOUT NOTICE  
DIMENSIONS ARE FOR REFERENCE ONLY

	S1	S2
SHAPE	PLANO	PLANO
SURFACE QUALITY	80-50	80-50
CLEAR APERTURE	≥90%	≥90%
BEVEL	PROTECTIVE AS NEEDED	PROTECTIVE AS NEEDED



ALL DIMS IN mm

**EO**® **Edmund Optics**®

TITLE

Ø100 x 6.5mm, UNCOATED, BOROFLOAT ®  
WINDOW

DWG NO

43895

SHEET  
1 OF 1