

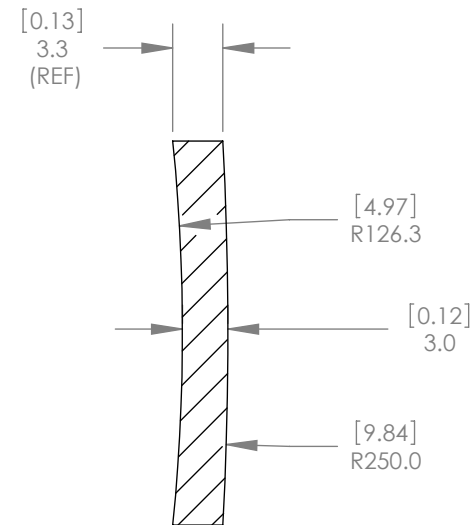

1:1 ISOMETRIC VIEW FOR REFERENCE ONLY

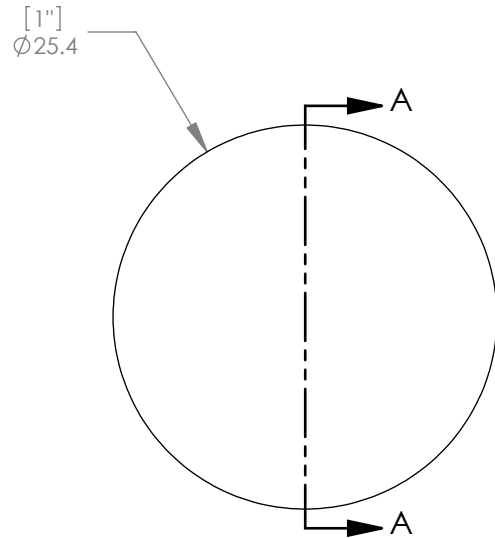

SECTION A-A

NOTES/SPECIFICATIONS:

1. DESIGN WAVELENGTH: 587.6nm
2. FOCAL LENGTH: $f = -498.4\text{mm} \pm 1\%$
3. BACK FOCAL LENGTH(REF): $bf = -496.3\text{mm}$
4. CLEAR APERTURE: >90%
5. SURFACE QUALITY: 40-20 SCRATCH-DIG
6. CENTRATION: <3arcmin
7. DIAMETER TOLERANCE: +0.0/-0.1mm
8. THICKNESS TOLERANCE: $\pm 0.1\text{mm}$
9. COATING: BBAR $R_{avg} < 0.5\%$ FROM 350nm-700nm, 0° AOI, ON OUTER OPTICAL SURFACES

ALL DIMENSIONS ARE IN THE FORM [in]
mm:
THIS DRAWING IS FOR INFORMATION ONLY
NOT INTENDED FOR MANUFACTURING

THORLABS INC. PO BOX 366
NEWTON NJ

TITLE: D=25.4 F=-500.0 N-BK7 A
COAT - MENISCUS LENS

MATERIAL: N-BK7 SIZE A REV. B

SCALE: 2:1 SHEET 1 OF 1

DWG. NO. 4876-E01 PART NO. LF1988-A

	NAME	DATE
DRAWN	WD	11/19/2009
ENG APPR.	BW	11/24/2009
MFG APPR.	DD	12/09/2009

PROPRIETARY AND CONFIDENTIAL

THE INFORMATION CONTAINED IN THIS DRAWING IS THE SOLE PROPERTY OF THORLABS, INC. ANY REPRODUCTION IN PART OR AS A WHOLE WITHOUT THE WRITTEN PERMISSION OF THORLABS, INC. IS PROHIBITED.