

TLK-L1900M - December 26, 2017

Item # TLK-L1900M was discontinued on December 26, 2017. For informational purposes, this is a copy of the website content at that time and is valid only for the stated product.

TUNABLE LASERS: PREALIGNED LITTROW AND LITTMAN KITS

- ▶ **Modular External Cavity Laser Kits Offer Highly Customizable Solutions**
- ▶ **Littrow and Littman Cavity Configurations**
- ▶ **Design Great for Education, Research, or Industry**



TLK-L1300R
 1310 nm Littrow Configuration
 Laser Kit, Top View



TLK-L1900M
 1900 nm Littman Configuration
 Laser Kit

[Hide Overview](#)

OVERVIEW

Features

- Choose from Standard Center Wavelengths from 1220 nm to 1950 nm
- FC/APC-Fiber-Coupled Output
- Compatible with Half-Butterfly Gain Chips
- Linewidths Less than 130 kHz
- Picometer Wavelength Resolution
- Reconfigurable by Changing Gain Chip and Grating
- Optional Integration of AR-Coated Gain Chip or Laser Diode
- Components and Accessories Available from Stock

Item # ^a	CWL ^b	Typical 10 dB Tuning	Typical Power	Output
TLK-L1220R	1220 nm	90 nm	40 mW	Fiber Coupled ^c
TLK-L1300R	1310 nm	100 nm	50 mW	Fiber Coupled ^c
TLK-L1550M	1550 nm	120 nm	35 mW	Fiber Coupled ^c
TLK-L1900M	1900 nm	120 nm	7 mW	Fiber Coupled ^c
TLK-L1950R	1950 nm	120 nm	7 mW	Fiber Coupled ^c

- For Full List of Specs, See the *Specs* Tab
- Center Wavelength
- Standard Fiber-Coupled Tunable Laser Kits have FC/APC Connectors. Customized Connectors are Available. Contact Tech Support for More Information.

Thorlabs' line of Tunable Laser Kits is designed for superior cavity construction flexibility and high-stability performance. The external cavity laser (ECL) design produces stable, narrow-linewidth (100 kHz typical) output with excellent tuning range and control (see the *Specs* and *Graphs* tabs for additional information). Integrated TEC elements allow the user (through the use of the proper TEC driver) to temperature control these kits, adding to the stability and lifetime of the laser diode. While our kits are aligned and tested before shipping, it will be necessary to tweak the alignment upon receipt to maximize performance.

Available in either a Littrow or Littman configuration, these external cavity laser kits are complete systems that only require drive electronics to operate (Laser Diode and TEC controllers). They are ideal for education, component testing, and research due to their modularity. Components are offered to create a tunable laser at a non-standard wavelength (see the *Conversion Guide* tab for more information). Various gain chips, cavity optics, and tuning actuators are available

to provide customizable ECL solutions. Additionally, customer-furnished ECL components can be easily integrated, which minimizes construction time and cost compared to other tunable laser alternatives.

Please contact our Tech Support for information on custom Tunable Laser Kit configurations.

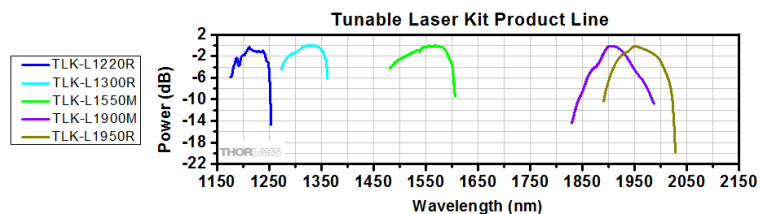

[Hide Graphs](#)

GRAPHS

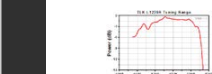

[Click to Enlarge](#)

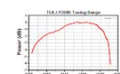

[Click to Enlarge](#)

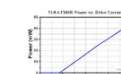

[Click to Enlarge](#)

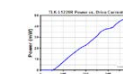

[Click to Enlarge](#)

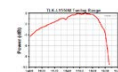

[Click to Enlarge](#)

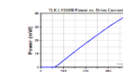

[Click to Enlarge](#)

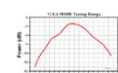

[Click to Enlarge](#)

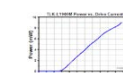

[Click to Enlarge](#)

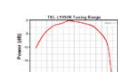

[Click to Enlarge](#)

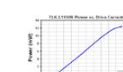

[Click to Enlarge](#)

[Hide Specs](#)

SPECS

1220 nm Tunable Laser Kit

Item #	TLK-L1220R		
	Min	Typ	Max
Center Wavelength	1200 nm	1220 nm	1240 nm
Tuning Range (10 dB)	80 nm	90 nm	-
Peak Power	30 mW	40 mW	-
Wavelength Tuning Resolution	2.5 pm	-	-
Tuning Speed (with Z812)	-	-	25 nm/s
Linewidth	-	100 kHz	130 kHz
Side Mode Suppression Ratio	30 dB	45 dB	-
Polarization Extinction Ratio	-	N/A	-
Power Stability (30 s)*	1%	-	-
Power Stability (24 hr)*	10%	-	-
Wavelength Stability (30 s)*	-	-	4 pm
Wavelength Stability (24 hr)*	-	-	50 pm

*Measurements taken with laser operating in open loop.

1310 nm Tunable Laser Kits

Item #	TLK-L1300R

	Min	Typ	Max
Center Wavelength	1290 nm	1310 nm	1320 nm
Tuning Range (10 dB)	80 nm	100 nm	-
Peak Power	30 mW	50 mW	-
Wavelength Tuning Resolution	2 pm	-	-
Tuning Speed (with Z812)	-	-	20 nm/s
Linewidth	-	100 kHz	130 kHz
Side Mode Supression Ratio	30 dB	45 dB	-
Polarization Extinction Ratio	-	N/A	-
Power Stability (30 s)*	1%	-	-
Power Stability (24 hr)*	10%	-	-
Wavelength Stability (30 s)*	-	-	4 pm
Wavelength Stability (24 hr)*	-	-	50 pm

*Measurements taken with laser operating in open loop.

1550 nm Tunable Laser Kits

Item #	TLK-L1550M		
	Min	Typ	Max
Center Wavelength	1530 nm	1550 nm	1570 nm
Tuning Range (10 dB)	70 nm	120 nm	-
Peak Power	15 mW	35 mW	-
Wavelength Tuning Resolution	3 pm	-	-
Tuning Speed (with Z812)	-	-	35 nm/s
Linewidth	-	100 kHz	130 kHz
Side Mode Supression Ratio	30 dB	45 dB	-
Polarization Extinction Ratio	-	N/A	-
Power Stability (30 s)*	1%	-	-
Power Stability (24 hr)*	10%	-	-
Wavelength Stability (30 s)*	-	-	4 pm
Wavelength Stability (24 hr)*	-	-	50 pm

*Measurements taken with laser operating in open loop.

1900/1950 nm Tunable Laser Kits

Item #	TLK-L1900M			TLK-L1950R		
	Min	Typ	Max	Min	Typ	Max
Center Wavelength	1870 nm	1900 nm	1930 nm	1920 nm	1950 nm	1970 nm
Tuning Range (10 dB)	90 nm	120 nm	-	90 nm	120 nm	-
Peak Power	4 mW	7 mW	-	4 mW	7 mW	-
Wavelength Tuning Resolution	4 pm	-	-	3 pm	-	-
Tuning Speed (with Z812)	-	-	45 nm/s	-	-	32 nm/s
Linewidth	-	100 kHz	130 kHz	-	100 kHz	130 kHz
Side Mode Supression Ratio	30 dB	45 dB	-	30 dB	45 dB	-
Polarization Extinction Ratio	-	N/A	-	-	N/A	-
Power Stability (30 s)*	1%	-	-	1%	-	-
Power Stability (24 hr)*	10%	-	-	10%	-	-
Wavelength Stability (30 s)*	-	-	10 pm	-	-	10 pm
Wavelength Stability (24 hr)*	-	-	100 pm	-	-	100 pm

*Measurements taken with laser operating in open loop.

[Hide Pin Diagrams](#)

PIN DIAGRAMS



[Click to Enlarge](#)

TLK Break-Out Box for External Cavity Controllers. Included with Every TLK.

Laser Diode Driver^a (Female DB9)

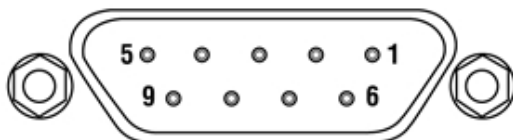

TEC Controller (Male DB9)

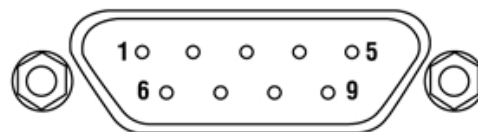

Pin	Description	Pin	Description	Pin	Description
1	Tied to Pin 5 ^b	4	PD Anode ^c	7	NC
2	PD Cathode ^c	5	Tied to Pin 1 ^b	8	LD Anode
3	LD Cathode	6	NC	9	NC

Pin	Description	Pin	Description	Pin	Description
1	NC	4	TEC +	7	NC
2	Thermistor +	5	TEC -	8	NC
3	Thermistor -	6	NC	9	NC

- With Thorlabs controllers, LD driver polarity must be set to Cathode Ground
- Bypasses interlock on Thorlabs' LD drivers, such as the ITC4001.
- Not used for Thorlabs half butterfly gain elements

Wavelength Tuning Motor (Male High-Density DB15)

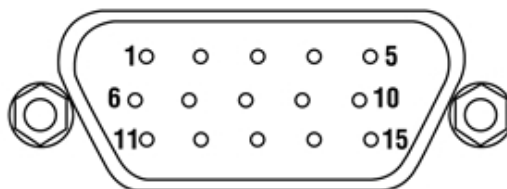

Pin	Description	Pin	Description
1	Ground (Limit and Vcc)	8	NC

2	Forward Limit	9	Ident Resistor
3	Reverse Limit	10	Vcc (5 V DC)
4	NC	11	Encoder Channel A
5	Motor (-)	12	NC
6	NC	13	Encoder Channel B
7	Motor (+)	14, 15	NC

[Hide What's Included](#)

WHAT'S INCLUDED



Above, a TLK-L1900M is pictured with its controller interface.

With each Tunable Laser Kit, we include the following:

- Tunable Laser, Factory Aligned for Out-of-the-Box Lasing
 - Half Butterfly Gain Chip - See *Conversion Guide* tab for List
 - Cavity Optic(s) - See *Conversion Guide* tab for List
 - DC Tuning Actuator (Z812)
- DC Servo Motor Controller and Power Supply with Location-Specific Adapter Plug for Wavelength Tuning
- Controller Interface for LD and TEC Connections
- Hex Keys for Building and Tuning Laser
- Test Report

What you will need:

- Laser Diode Controller and TEC Controller
 - Suggested: ITC4000 Series combined LD and TEC controller
 - Alternatively, you can use a separate LD controller and TEC controller

Suggested tools & accessories:

- IR Viewing Card to Align Laser Cavity
- Optical Power Meter to Maximize Performance of Laser

If you have any questions about what is included with each kit or what is needed to operate a Tunable Laser Kit, please contact Technical Support.

[Hide Component Guide](#)

COMPONENT GUIDE

The following tables and images depict the standard components of our Tunable Laser Kits. While the kits are shipped complete, these components are also available separately. This allows for a user to support different lasing wavelengths, and minimize downtime of the system should a laser need repair. For a list of the components required to change the lasing wavelength of a TLK, please see the *Conversion Guide* tab above.

Littman Tunable Laser Kits

Label	Description	Label	Description
A	Tuning Motor Mount	F	Collimating Lens
B	Gain Chip Mounting Plate	G	Littman Grating Platform
C	Half Butterfly Gain Chip	H	Littman Grating Module
D	Collimation Adjuster	I	Littman Mirror Module
E	Mode Hop Adjuster	J	Tuning Motor

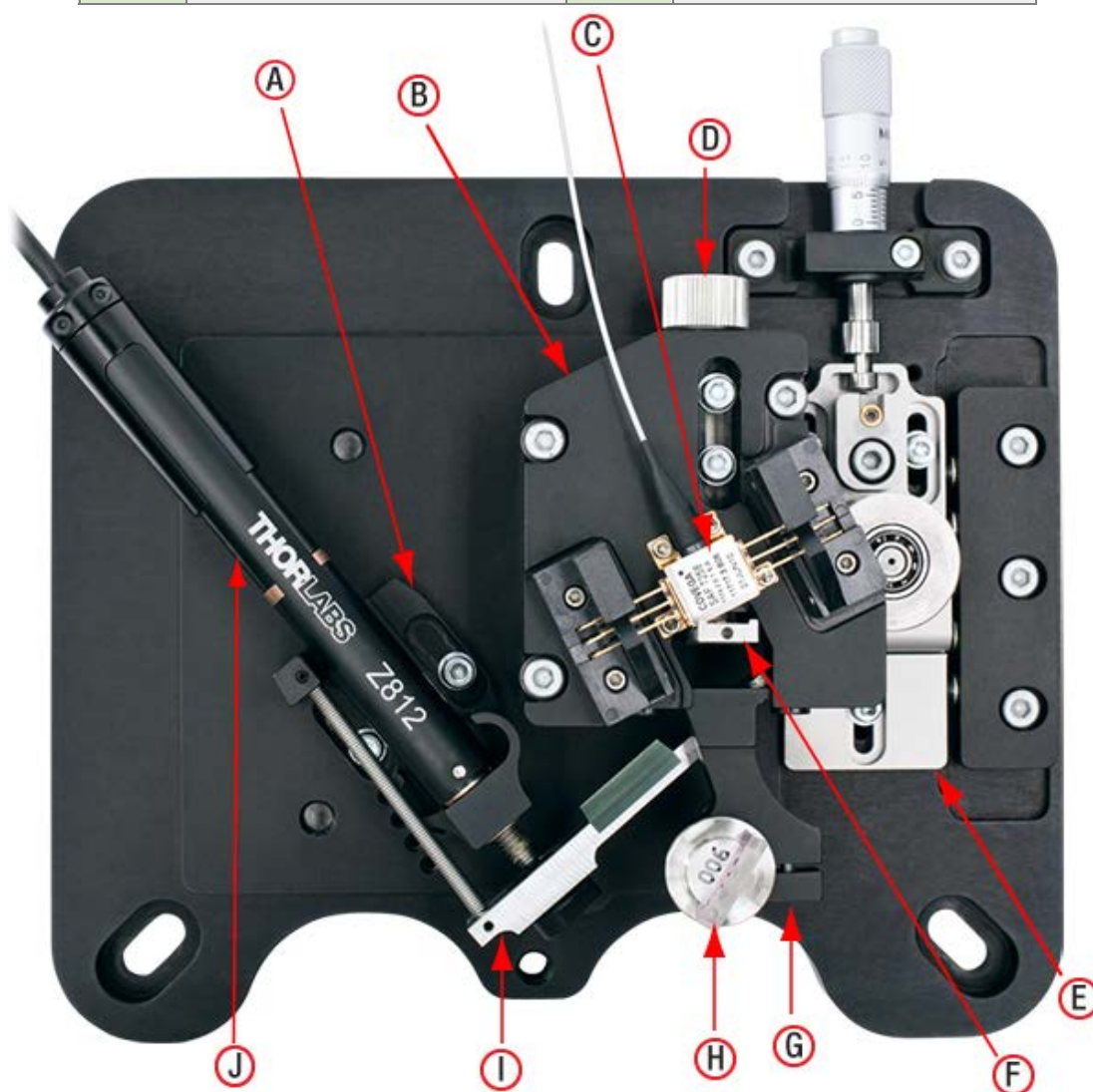

Littrow Tunable Laser Kits

Label	Description	Label	Description
A	Tuning Motor Mount	E	Mode Hop Adjuster
B	Gain Chip Mounting Plate	F	Collimating Lens
C	Half Butterfly Gain Chip	G	Littrow Grating Module
D	Collimation Adjuster	H	Tuning Motor

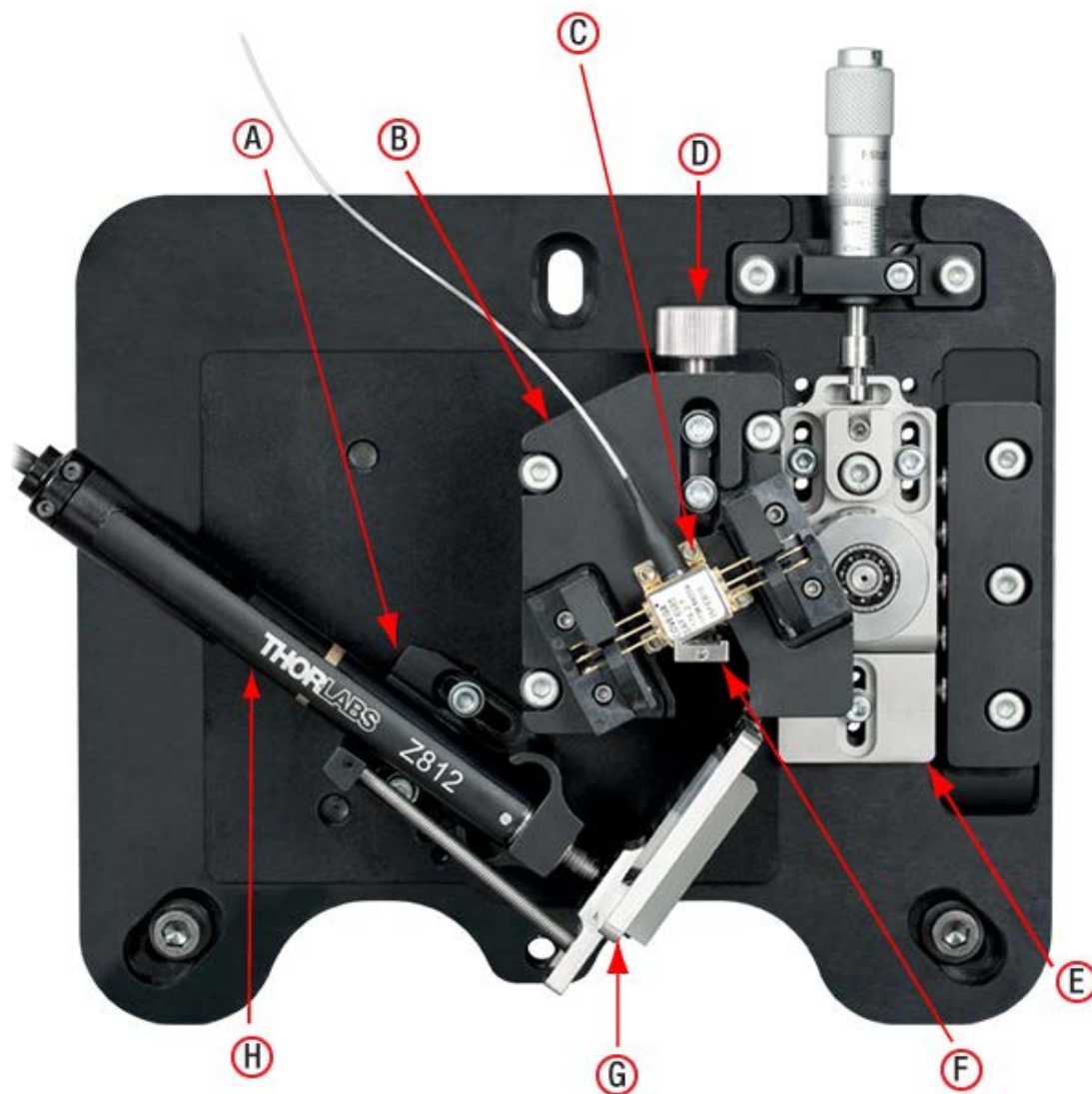

[Hide Conversion Guide](#)

CONVERSION GUIDE

Littman Cavity Configurations

These are the differentiating components of each Littman Tunable Laser Kit. The gain chip, top plate, grating module, and collimating lens are the components that you will need to convert from one supported wavelength to the next.

Included in Kit Item #	Center Wavelength	Gain Chip	Top Plate	Grating Module	Collimating Lens ^a
TLK-L1550M	1550 nm	SAF1550S2	TLK-P26	TLK-G0750M	TLK-352330-C ^c
TLK-L1900M	1900 nm	SAF1900S	TLK-P26	TLK-G0600M ^b	TLK-352330-C ^c

- Current TLKs use the 352230-B lens instead of the 352330-B lens used in the TLK-352330-B.
- This item is no longer available for individual purchase.
- Current TLKs use the 352230-C lens instead of the 352330-C lens used in the TLK-352330-C. However, using the TLK-352330-C will not affect the performance of the TLK.

Littrow Cavity Configurations

These are the differentiating components of each Littrow Tunable Laser Kit. The Gain Chip, Top Plate, Grating Module, and Collimating Lens are the components you will need to convert from one supported wavelength to the next.

Included in Kit Item #	Center Wavelength	Gain Chip	Top Plate	Grating Module	Collimating Lens ^a
TLK-L1220R	1220 nm	SAF1175S	TLK-P26	TLK-G1350R2	TLK-352330-C
TLK-L1300R	1310 nm	SAF1174S	TLK-P26	TLK-G1350R	TLK-352330-C
TLK-L1950R	1950 nm	SAF1900S	TLK-P26	TLK-G0900R	TLK-352330-C

- Current TLKs use the 352230-C lens instead of the 352330-C lens used in the TLK-352330-C. However, using the TLK-352330-C will not affect the performance of the TLK.

[Hide Applications](#)

APPLICATIONS

Absorption Spectroscopy

Absorption Spectroscopy is a common application for tunable lasers. This form of spectroscopy is used to determine the molecular content of a gas. By tuning the wavelength of the laser, one can record the absorption lines of the gas and thus discover its composition. These absorption lines occur when the frequency of the laser matches the energy difference of two quantum mechanical states of the gas molecules. Direct Absorption Spectroscopy and Saturated Absorption Spectroscopy are the two most common techniques and are outlined below.

Direct Absorption Spectroscopy

This simplified form of spectroscopy involves aiming a laser beam through a gas cell and monitoring the transmitted intensity while tuning the laser's wavelength. The gas absorption lines cause a portion of the laser beam's power to be absorbed. Due to Doppler effects, this form of spectroscopy is not great at resolving narrow linewidth absorption features.

Saturated Absorption Spectroscopy

Saturation absorption spectroscopy still uses only one laser source but is capable of resolving fine absorption features that Direct Absorption Spectroscopy cannot. In order to do this, it reduces Doppler effects by using counter-propagating pump beam and probe beams. The laser beam propagating from the tunable laser is split in to two beams using a beamsplitter. The higher power beam is known as the pump beam. This beam is directed through the gas cell. The second beam is the probe beam. With the use of a few mirrors, it is aligned nearly colinear, but counter-propagating, to the pump beam. Both beams should intersect within the gas cell. This reduces the Doppler effects that were apparent in the Direct Absorption Spectroscopy process above. The intensity of the probe beam is then measured with a photodetector.

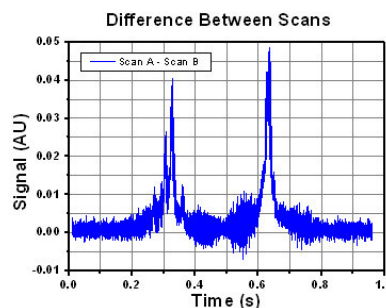
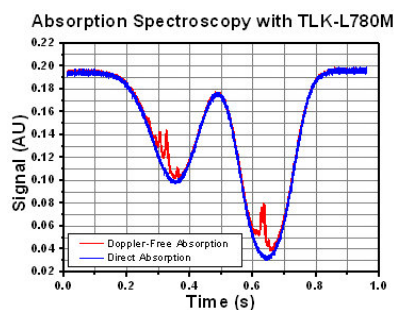

[Hide Cavity Configuration](#)

CAVITY CONFIGURATION

Lasers consist of an active gain element and optical feedback to this gain element. The most common diode lasers are based on a Fabry-Perot design with a linear waveguide and reflective surfaces at both ends of the gain chip to provide feedback. Some Fabry-Perot lasers are constructed for external feedback, but this is rare. Single-angle-facet (SAF) gain chips, on the other hand, have a curved waveguide with only one internally reflective endface and rely on external optical feedback to produce lasing.

Through the use of an external feedback mechanism, a user is able to tune a laser cavity to sustain a desired wavelength with minimal linewidth. This is highly desirable for many applications, particularly in metrology where precision is essential. Littrow and Littman-Metcalf configurations are the two most common ways to build an External Cavity Laser (ECL). Many other ECL configurations are based on these designs, but typically modify the cavity with additional optical components. Littrow cavities have minimal losses and thus intrinsically offer higher power, while Littman-Metcalf cavities produce a narrower linewidth.

Cavity Design	Littrow	Littman-Metcalf
High Output Power	x	
Wide Tuning Range	x	
Narrow Linewidth		x
Stationary 0 th Order Beam		x

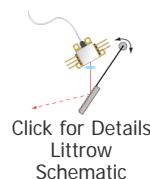



A Littrow cavity provides feedback to the gain element through the use of a grating. One end of the gain element must allow light to exit, such as in the design of an SAF. Light emitted from this end is first collimated. A grating then diffracts this collimated beam with the 1st order diffraction coupled back into the gain element, which allows it to support lasing. Wavelength tuning of the laser is possible by altering the angle of the grating relative to the cavity.

Littman-Metcalf configured ECLs use both a grating and a mirror for tuning. Similar to the Littrow configuration, light emitted from the uncoated end of the gain element must first be collimated. This beam is then diffracted by a grating. The 1st order diffraction reflects off of a mirror back on to the grating, where it is diffracted a second time before being coupled back into the gain element. Since light is diffracted twice, losses are higher (power loss), but the side mode suppression ratio (SMSR) is increased to produce a narrower linewidth laser. In this configuration the grating remains stationary, while the mirror is turned to tune the laser cavity's supported wavelength. The 1st order diffraction is coupled back into the gain element and comprises the output beam. The direction of emission is controlled by the fiber.

If not using Thorlabs' enclosure for these TLK kits, it is suggested to physically block the undesired orders reflected from the grating. Keep in mind that for the Littrow configuration, these beams will move when the grating is tuned.

Many modifications to these cavities can be made to produce a higher polarization extinction ratio (PER) or to improve the SMSR. We always seek to tailor our products to our customers' applications. Please contact Tech Support and let us know what accessories would benefit your application.

[Hide ECL Tutorial](#)

ECL TUTORIAL

External Cavity Diode Lasers

Tunable Wavelength and Narrow Linewidth



Two elements are required for a laser to operate: (1) an active gain medium that amplifies the optical signal and (2) a feedback mechanism to provide sustained laser oscillation. In a Fabry-Perot laser, two mirrors having a reflection coefficient r_1 and r_2 (power reflectance $R_1 = r_1^2$ and $R_2 = r_2^2$) provide feedback for the optical field, as shown in Figure 1.

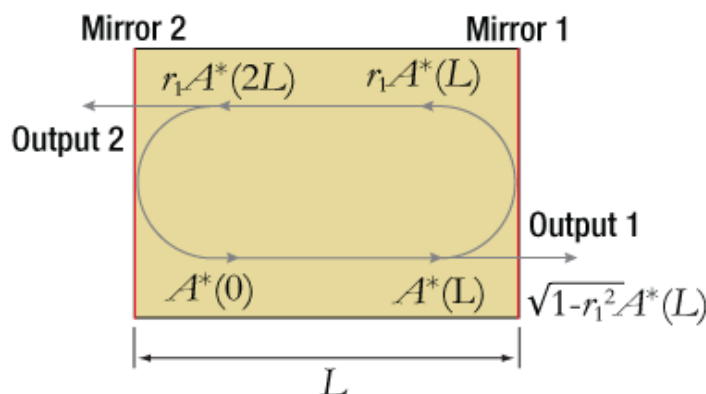

Figure 1: Fabry-Perot Laser Structure

The round-trip gain for the optical field within a cavity of length L can be expressed as:

$$\sqrt{G_{RT}} = r_1 r_2 e^{(g - \alpha_i)L} e^{-j \frac{2\pi n_{eff}}{\lambda} 2L}$$

Equation 1: Round-trip Gain for Optical Field

where g and α_i are the gain and internal loss coefficients, respectively, λ is the vacuum wavelength, n_{eff} is the effective refractive index, and L is the cavity length. Solving for unity results in the threshold amplitude and phase conditions:

$$g_{th} = \alpha_i + \frac{1}{2L} \ln \left(\frac{1}{R_1 R_2} \right) = \alpha_i + \alpha_m$$

Equation 2: The amplitude condition

$$\lambda_N = \frac{2n_{eff}L}{N}$$

Equation 3: The phase condition

where α_m is defined as the mirror loss and N is a running integer index representing the mode number.

In a semiconductor (diode) laser, the gain medium is excited by injecting a current into the junction region of a forward biased diode. The high concentration of electrons and holes in the engineered quantum-well junction of a semiconductor laser makes it possible to create the population inversion required for optical gain.

When the gain medium is a semiconductor material, a Fabry-Perot cavity can be created by the Fresnel optical reflections at the cleaved facets of the chip. The junction is effectively a waveguide that extends from one facet to the other. An uncoated "as-cleaved" facet perpendicular to the waveguide has a reflectivity of $R \sim 30\%$. However, the maximum output power of the device can be optimized by modifying the reflectance of the facets with optical coatings. Maximum power for a Fabry-Perot laser diode is typically achieved with a high-reflectivity (HR) coating on the back facet and a low-reflectivity (LR) coating on the front facet.

The emission spectrum of the Fabry-Perot laser diode device will be dependent on the injection current. When biased below threshold with $g > \alpha_i$ the emission spectrum consists of a broad series of peaks corresponding to the longitudinal modes of the Fabry-Perot cavity defined by the phase equation. Lasing does not occur until the injection current is increased to the point where $g = \alpha_i + \alpha_m$. The lasing wavelength is determined by the longitudinal mode that first achieves the threshold condition. The output spectrum does not always collapse into a single lasing wavelength but can consist of a narrow spectrum of longitudinal modes.

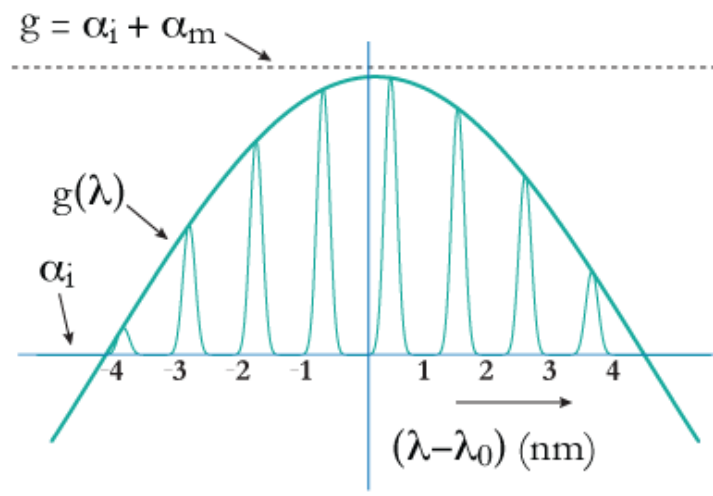

Figure 2: Gain Curve of a Fabry-Perot Laser

This is particularly true for InP-based Fabry-Perot lasers, which typically have an optical bandwidth of 5 to 10 nm. GaAs-based devices can operate in a single longitudinal mode, depending on wavelength and output power. they typically have an output bandwidth <2 nm.

A typical 850 nm laser diode with a length of around 300 μm and a group index around 4 will have a longitudinal mode spacing of 0.3 nm, which is similar to a 1 mm long 1550 nm laser diode. Changing the length or refractive index of the cavity, for example by heating or cooling the laser diode, will shift the whole comb of modes and consequently the output wavelength.

Laser Linewidth

The linewidth of a semiconductor laser single longitudinal lasing mode (FWHM) is given by the modified Schawlow and Townes formula that incorporates the Henry linewidth enhancement factor α_H : [1]

$$\Delta\nu = \frac{h\nu v_g^2 (\alpha_i + \alpha_m) \alpha_m n_{sp}}{8\pi P_{out}} (1 + \alpha_H^2)$$

Equation 4: Schawlow-Townes-Henry Laser Linewidth

where $h\nu$ is the photon energy, v_g is the group velocity, n_{sp} is the population inversion factor, and P_{out} is the single-facet output power. this equation describes the spectral broadening of the laser linewidth due to phase and amplitude fluctuations caused by the unavoidable addition of spontaneous emission photons to the coherent lasing mode. These so-called quantum noise fluctuations define a lower limit on the laser linewidth, which may be masked by larger noise fluctuations caused by mechanical/acoustic vibration or thermal variation.

Extending the length of the cavity will decrease α_m (see Eq. 2), which reduces the linewidth. This can be understood by viewing the quantum noise-limited linewidth (see Eq. 4) as being proportional to the ratio of the number of spontaneous emission photons in the lasing mode. Increasing the cavity length both reduces the number of spontaneous emission photons (by decreasing the "cold-cavity" spectral width of each longitudinal mode) and increases the total number of photons in the cavity for a fixed output power. this is why the cavity length term appears twice in the Schallow-Townes equation.

A single-frequency distributed feedback (DFB) diode laser with cavity of 0.3 mm will typically have an emission linewidth on the order of 1 to 10 MHz. Increasing the length of the cavity to 3 cm, for example, will narrow the emission linewidth by a factor of more than 100. It has been shown [2] that the linewidth of the emission from an extended cavity semiconductor lasers can be reduced to <1 kHz.

Single Wavelength Operation and Tuning

For many applications, it is desirable to have a single longitudinal mode (single frequency) laser, to be able to adjust the lasing wavelength, or both. To accomplish this, a wavelength-selective feedback element external to the semiconductor laser chip can be used to select the lasing wavelength. Proper operation of this external cavity laser (ECL) requires suppression of the intrinsic optical feedback from the semiconductor chip Fabry-Perot cavity so that it does not interfere with the external feedback. The gain chip's Fabry-Perot cavity effect can be reduced by applying an antireflection (AR) optical coating to one chip facet.

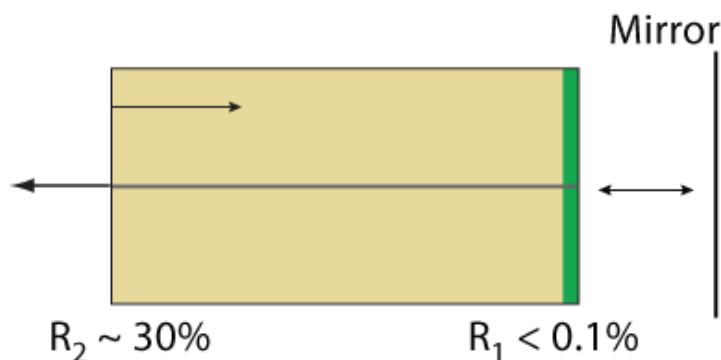

Figure 3: External Cavity Operation Based on a Gain Chip

At a minimum, the chip facet reflectance (R_1) should be 20 dB less than the external feedback (R_{ext}); that is, $R_1 < 10^{-2} \times R_{ext}$. [3] Even with the AR coating, the residual reflection from the AR-coated Fabry-Perot gain chip facet often limits the stability, output power, and spectral quality of the ECL, especially if the laser is tunable. To further reduce the reflection at the chip facet, the combination of an angled waveguide and an AR coating can be used to effectively remove most of the feedback from the internal chip Fabry-Perot cavity. [4] This single-angled-facet (SAF) gain chip provides a superior structure for ECLs, in particular broadband tunable ECLs.

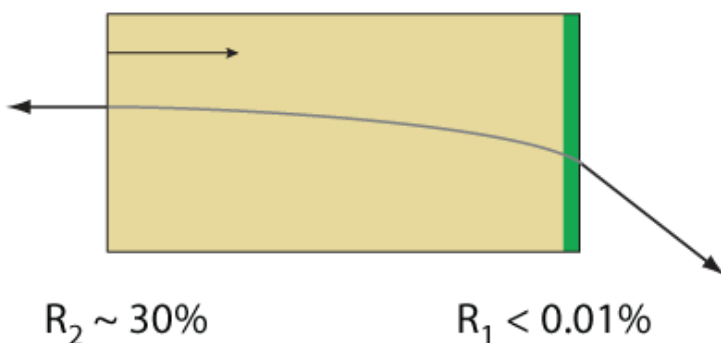

Figure 4: Single-Angled-Facet Gain Chip

External Cavity Laser Design

There are numerous approaches for implementing an external cavity semiconductor laser. [3] The first consideration for most approaches is the choice of a wavelength selective feedback element. One of the most common feedback elements is a diffraction grating, which can be used as the feedback element in both single-frequency and broadly tunable external cavity lasers.

When the collimated output of the gain chip is incident on a diffraction grating at angle θ with respect to the grating surface normal and perpendicular to the grating lines, the diffracted beams exit the grating at an angle θ' determined by the grating equation:

$$n\lambda = d(\sin\theta + \sin\theta')$$

Equation 5: Grating Equation

Here, n is the order of diffraction, λ is the diffracted wavelength, and d is the grating constant (the distance between grooves). For $n > 0$, the diffraction grating will spatially separate a polychromatic incident beam by diffracting the beam at an angle θ' , which is wavelength dependent. Once the spectral content of the gain chip is spatially separated, a variety of means can be employed to selectively reflect light with a specific wavelength back into the gain medium.

Littrow ECL Configuration

One of the simplest approaches is to use a Littrow configuration where the diffraction grating is oriented so that the first-order diffraction is retroreflected back into the gain chip [i.e., $\theta = \theta'$ in Eq. (5) above]:

$$n\lambda = 2d(\sin\theta)$$

Equation 6: Grating Equation, Littrow Configuration

The laser output power can be taken from the zero-order reflection of the grating, which is often done because it minimizes the number of optical elements required to construct the ECL (a collimating lens and the diffraction grating).

Wavelength tuning is accomplished by rotating the diffraction grating, which varies the wavelength of light that is reflected back into the waveguide. When the diffraction grating (grating constant), collimation lens, and cavity length are chosen so that only one longitudinal mode is reflected back to the gain chip within the acceptance angle of the waveguide, the external cavity laser will produce a single frequency laser spectrum. Note that the selection of collimation lens is important because it affects the amount of grating area that is illuminated as well as the focused spot size coupling back into the semiconductor gain chip. One of the disadvantages of this configuration is that the angle of the zero-order output beam changes as the wavelength is tuned. However, this problem can be avoided if the output of the ECL is emitted from the normal facet of the SAF gain chip. In this configuration, the reflectance of the SAF normal facet is typically reduced to $R \sim 10\%$ and a grating is chosen that efficiently diffracts light into the order being used to create the ECL to maximize the output power of the laser.

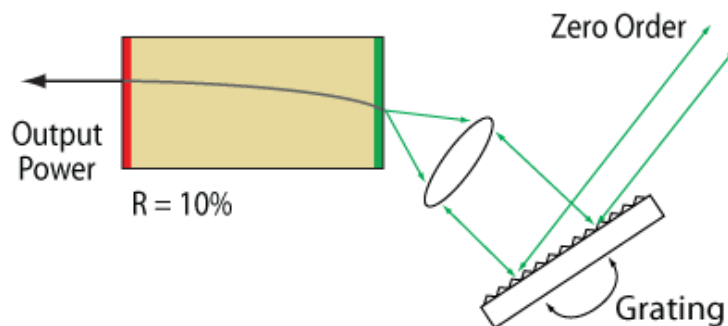

Figure 5: Littrow External Cavity Laser

Littman-Metcalf ECL Configuration

Another common ECL implementation is the Littman-Metcalf configuration, which uses an additional adjustable mirror to select the feedback wavelength. [5] The double-pass of the diffraction grating at an increased angle of incidence results in an external cavity that has better wavelength selectivity. As a result, the output beam of a Littman-Metcalf ECL typically has a narrower linewidth than a similar laser built using a Littrow configuration. In the Littman-Metcalf configuration, the output beam of the laser is typically the zero-order reflection from the diffraction grating, since the propagation direction remains fixed as the wavelength is tuned. In this case, the SAF normal facet is coated with a high-reflective (HR) coating, typically $>90\%$, in order to minimize the losses in the ECL, which maximizes the output power.

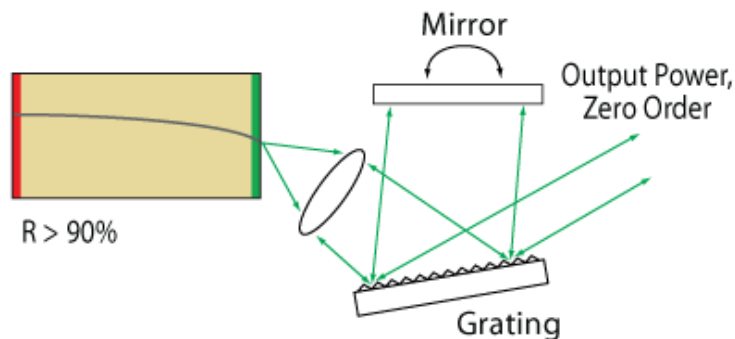

Figure 6: Littman-Metcalf External Cavity Laser

For some applications it may still be desirable to use the normal facet of the SAF chip as the output coupler of the laser. For these applications, a low reflection coating on the normal facet of the SAF gain chip would be required in order to maximize the output power of the laser.

One drawback to the Littman-Metcalf design is that the internal losses are higher than in the Littrow configuration, and hence, the output power of the laser is typically lower. The increase in internal losses are mainly due to the loss of the zero-order beam reflected from the tuning mirror and the increased loss due to the decrease in the efficiency of the grating when used to reflect light at a large angle of incidence.

Innovative ECL Design

The innovative design of an SAF gain chip is ideal for use in external cavity lasers because it virtually eliminates the unwanted feedback from the intracavity facet of the gain chip. Thorlabs offers SAF chips with both low- and high-reflectivity coatings on the normal facet in order to support a wide variety of external cavity configurations. For information on custom coatings that optimize the performance of a particular external cavity laser configuration, please contact Tech Support.

- 1) C. H. Henry, "Theory of the Linewidth of Semiconductor Lasers" IEEE J. of Quantum electron, QE-18, 259 (1982).
- 2) R. Wyatt, K. H. Cameron and M. R. Matthews, "Tunable Narrow Line External Cavity Lasers for Coherent Optical Communication Systems", Br. Telecom. Technol. J. 3, 5 (1985).
- 3) P. Zorabedian, "Tunable External Cavity Semiconductor Lasers." Tunable Lasers Handbook, Ed. F. J. Duarte. New York, Academic, 1995. Chapter 8.
- 4) P. J. S. Heim, Z. F. Fan, S. -H. Cho, K. Nam, M. Dagenais, F. G. Johnson and R. Leavitt, "Single-angled-facet Laser Diode for Widely Tunable External Cavity Semiconductor Lasers with High Spectral Purity", Electron. Lett., 33, 1387 (1997).
- 5) M. G. Littman and H. J. Metcalf, "Spectrally narrow pulsed dye laser without beam expander," App. Opt. 17, 2224 (1978).

[Hide Laser Safety](#)

LASER SAFETY

Laser Safety and Classification

Safe practices and proper usage of safety equipment should be taken into consideration when operating lasers. The eye is susceptible to injury, even from very low levels of laser light. Thorlabs offers a range of laser safety accessories that can be used to reduce the risk of accidents or injuries. Laser emission in the visible and near infrared spectral ranges has the greatest potential for retinal injury, as the cornea and lens are transparent to those wavelengths, and the lens can focus the laser energy onto the retina.









Safe Practices and Light Safety Accessories

- Thorlabs recommends the use of safety eyewear whenever working with laser beams with non-negligible powers (i.e., > Class 1) since metallic tools such as screwdrivers can accidentally redirect a beam.
- Laser goggles designed for specific wavelengths should be clearly available near laser setups to protect the wearer from unintentional laser reflections.
- Goggles are marked with the wavelength range over which protection is afforded and the minimum optical density within that range.
- Laser Safety Curtains and Blackout Materials can prevent direct or reflected light from leaving the experimental setup area.
- Thorlabs' Enclosure Systems can be used to contain optical setups to isolate or minimize laser hazards.
- A fiber-pigtailed laser should always be turned off before connecting it to or disconnecting it from another fiber, especially when the laser is at power levels above 10 mW.
- All beams should be terminated at the edge of the table, and laboratory doors should be closed whenever a laser is in use.
- Do not place laser beams at eye level.
- Carry out experiments on an optical table such that all laser beams travel horizontally.
- Remove unnecessary reflective items such as reflective jewelry (e.g., rings, watches, etc.) while working near the beam path.
- Be aware that lenses and other optical devices may reflect a portion of the incident beam from the front or rear surface.
- Operate a laser at the minimum power necessary for any operation.
- If possible, reduce the output power of a laser during alignment procedures.
- Use beam shutters and filters to reduce the beam power.
- Post appropriate warning signs or labels near laser setups or rooms.
- Use a laser sign with a lightbox if operating Class 3R or 4 lasers (i.e., lasers requiring the use of a safety interlock).
- Do not use Laser Viewing Cards in place of a proper Beam Trap.



Laser Classification

Lasers are categorized into different classes according to their ability to cause eye and other damage. The International Electrotechnical Commission (IEC) is a global organization that prepares and publishes international standards for all electrical, electronic, and related technologies. The IEC document 60825-1 outlines the safety of laser products. A description of each class of laser is given below:

Class	Description	Warning Label
1	This class of laser is safe under all conditions of normal use, including use with optical instruments for intrabeam viewing. Lasers in this class do not emit radiation at levels that may cause injury during normal operation, and therefore the maximum permissible exposure (MPE) cannot be exceeded. Class 1 lasers can also include enclosed, high-power lasers where exposure to the radiation is not possible without opening or shutting down the laser.	
1M	Class 1M lasers are safe except when used in conjunction with optical components such as telescopes and microscopes. Lasers belonging to this class emit large-diameter or divergent beams, and the MPE cannot normally be exceeded unless focusing or imaging optics are used to narrow the beam. However, if the beam is refocused, the hazard may be increased and the class may be changed accordingly.	
2	Class 2 lasers, which are limited to 1 mW of visible continuous-wave radiation, are safe because the blink reflex will limit the exposure in the eye to 0.25 seconds. This category only applies to visible radiation (400 - 700 nm).	
2M	Because of the blink reflex, this class of laser is classified as safe as long as the beam is not viewed through optical instruments. This laser class also applies to larger-diameter or diverging laser beams.	
3R	Lasers in this class are considered safe as long as they are handled with restricted beam viewing. The MPE can be exceeded with this class of laser, however, this presents a low risk level to injury. Visible, continuous-wave lasers are limited to 5 mW of output power in this class.	
3B	Class 3B lasers are hazardous to the eye if exposed directly. However, diffuse reflections are not harmful. Safe handling of devices in this class includes wearing protective eyewear where direct viewing of the laser beam may occur. In addition, laser safety signs lightboxes should be used with lasers that require a safety interlock so that the laser cannot be used without the safety light turning on. Class-3B lasers must be equipped with a key switch and a safety interlock.	
4	This class of laser may cause damage to the skin, and also to the eye, even from the viewing of diffuse reflections. These hazards may also apply to indirect or non-specular reflections of the beam, even from apparently matte surfaces. Great care must be taken when handling these lasers. They also represent a fire risk, because they may ignite combustible material. Class 4 lasers must be equipped with a key switch and a safety interlock.	
All class 2 lasers (and higher) must display, in addition to the corresponding sign above, this triangular warning sign		

[Hide Tunable Laser Kits, Fiber-Coupled Littman Configuration](#)

Tunable Laser Kits, Fiber-Coupled Littman Configuration

Thorlabs' Littman configuration kits, which share many components with the Littrow kits, are available with a 1550 or 1900 nm gain element. The design difference between Littman and Littrow configurations is the wavelength selection mechanism (see the *Cavity Configuration* tab for more information). Unlike the Littrow configuration, the Littman configuration has a fixed grating angle. Light diffracted from the grating is then reflected off of a mirror, diffracted a second time by the grating, and coupled back into the gain element. Since light undergoes diffraction twice in this configuration, this laser cavity configuration typically offers narrower linewidths while sacrificing power and tuning range.



The fiber output from the TLK-L1900M should be mated to a fiber isolator for specified performance as the half butterfly gain chip does not have an integrated isolator. Please contact us for details.

Part Number	Description	Price	Availability
TLK-L1550M	Tunable Laser Kit, 1550 nm, Littman Configuration, FC/APC	\$9,720.00	Today

[Hide Tunable Laser Kits, Fiber-Coupled Littrow Configuration](#)

Tunable Laser Kits, Fiber-Coupled Littrow Configuration

The standard Littrow kits are available with 1220, 1310, or 1950 nm center wavelengths. The fiber-coupled single-angle-facet (SAF) gain chips in these kits provide excellent tuning ranges and output powers. The design difference between Littman and Littrow configurations is the wavelength selection mechanism (see the *Cavity Configuration* tab for more information). The Littrow cavities are configured as shown in the image to the right, such that the light emitted from the gain element is collimated by the lens and then diffracted by a grating. Diffracted light that is coupled back into the gain element provides wavelength selection based on the angle of the grating, thus making the cavity wavelength tunable. Since



light undergoes diffraction once, this laser cavity configuration typically offers higher power and slightly larger linewidths compared to the Littman configuration.

The fiber output from the TLK-L1950R should be mated with an fiber isolator for specified performance as the half butterfly gain chip does not have an integrated isolator. Please contact us for details.

Part Number	Description	Price	Availability
TLK-L1950R	Customer Inspired!Tunable Laser Kit, 1950 nm, Littrow Configuration, FC/APC	\$9,720.00	Today