

NOTES:

1. SUBSTRATE:
KBR
2. COATING (APPLY ACROSS CLEAR APERTURE)
S1 & S2: NONE
3. FINE GRIND SURFACE
4. RoHS COMPLIANT

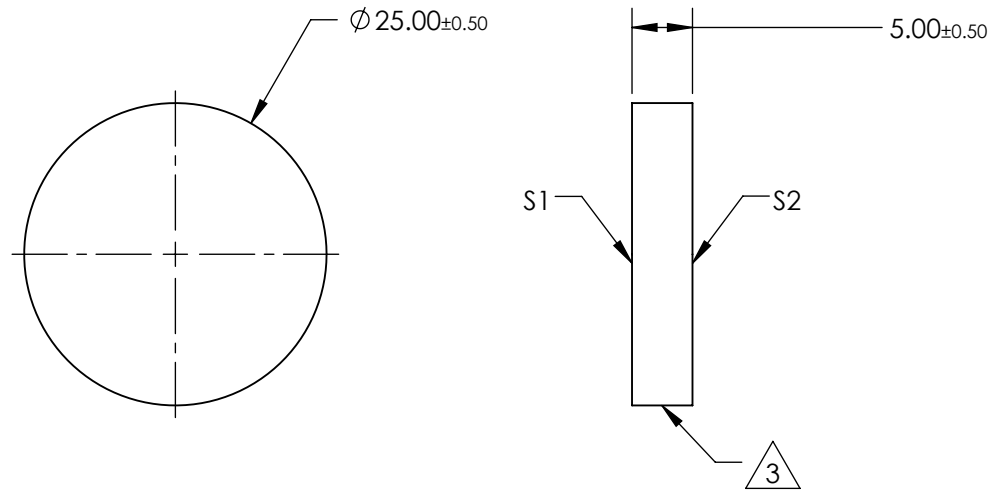
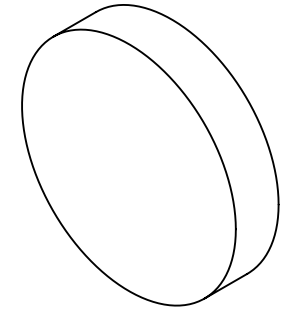

**FOR INFORMATION ONLY:
DO NOT MANUFACTURE
PARTS TO THIS DRAWING**

SPECIFICATIONS SUBJECT TO CHANGE WITHOUT NOTICE
DIMENSIONS ARE FOR REFERENCE ONLY

EO® Edmund Optics®

	S1	S2	THIRD ANGLE PROJECTION		TITLE	Ø25mm x 5mm THICKNESS, UNCOATED, POTASSIUM BROMIDE WINDOW	
SHAPE	PLANO	PLANO	ALL DIMS IN	mm	DWG NO	68809	SHEET 1 OF 1
SURFACE QUALITY	80-50	80-50					
BEVEL	PROTECTIVE AS NEEDED	PROTECTIVE AS NEEDED					