

NOTES:

1. SUBSTRATE:
GERMANIUM (GE)
2. SURFACE S2 TO BE PARALLEL TO S1 WITHIN 1 ARCMIN
3. ANTI REFLECTION SURFACE TREATMENT (APPLY ACROSS CLEAR APERTURE)
S1 & S2: RAVG <3.0% @ 8 - 12µm

△ 4. FINE GRIND SURFACE

5. RoHS COMPLIANT

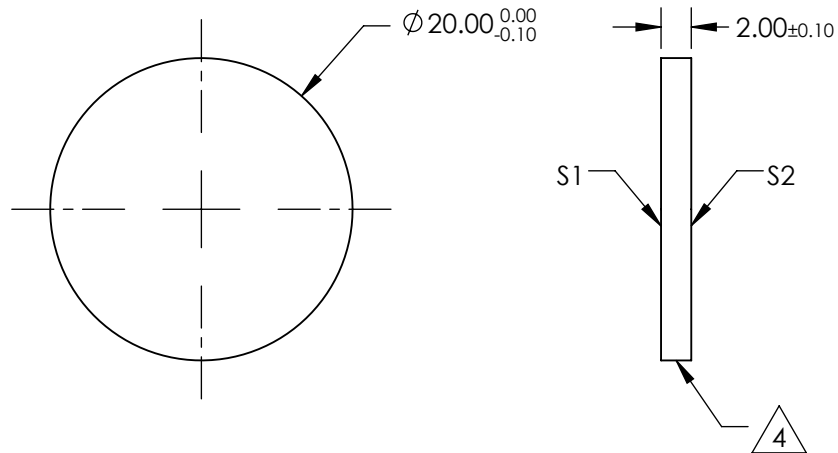
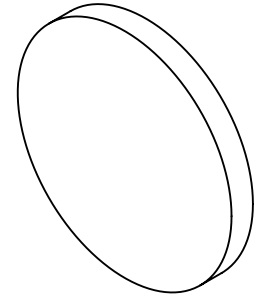

**FOR INFORMATION ONLY:
DO NOT MANUFACTURE
PARTS TO THIS DRAWING**

SPECIFICATIONS SUBJECT TO CHANGE WITHOUT NOTICE
DIMENSIONS ARE FOR REFERENCE ONLY

EO® Edmund Optics®

	S1	S2
SHAPE	PLANO	PLANO
SURFACE QUALITY	60-40	60-40
SURFACE FLATNESS	λ/10 @ 10.6µm	λ/10 @ 10.6µm
BEVEL	PROTECTIVE AS NEEDED	PROTECTIVE AS NEEDED

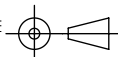
THIRD ANGLE PROJECTION 

ALL DIMS IN mm

TITLE	Ø20mm x 2mm THICK, 8 - 12µm AR COATED, GE WINDOW		
DWG NO	63213	SHEET	1 OF 1