

SEE SHEET 2

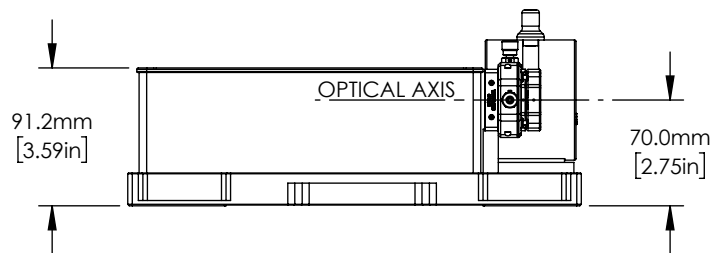

SEE SHEET 3

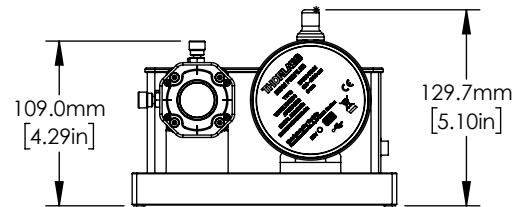

SEE SHEET 4

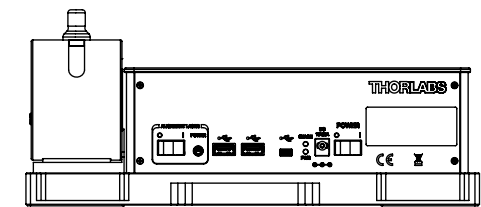

SEE SHEET 4

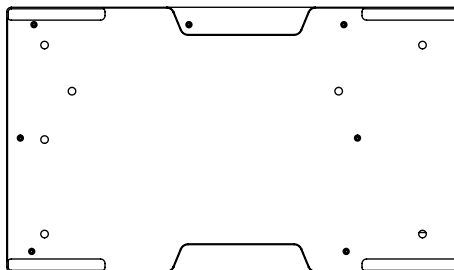

SEE SHEET 3

FOR INFORMATION ONLY
NOT FOR MANUFACTURING PURPOSES

FOR MORE INFORMATION SEE NEXT PAGES

DRAWING PROJECTION			THORLABS www.thorlabs.com	
NAME	DATE	M ² MEASUREMENT SYSTEM WITH BP209-IR2/M, 900-2700nm, METRIC		
DRAWN	Hit.	12/JUN/17	MATERIAL	REV
APPROVAL	RR	12/JUN/17	N/A	A
COPYRIGHT © 2017 BY THORLABS			ITEM #	APPROX WEIGHT
VALUES IN PARENTHESIS ARE CALCULATED AND MAY CONTAIN ROUND-OFF ERRORS			M2MS-BP209IR2/M	4.6 kg

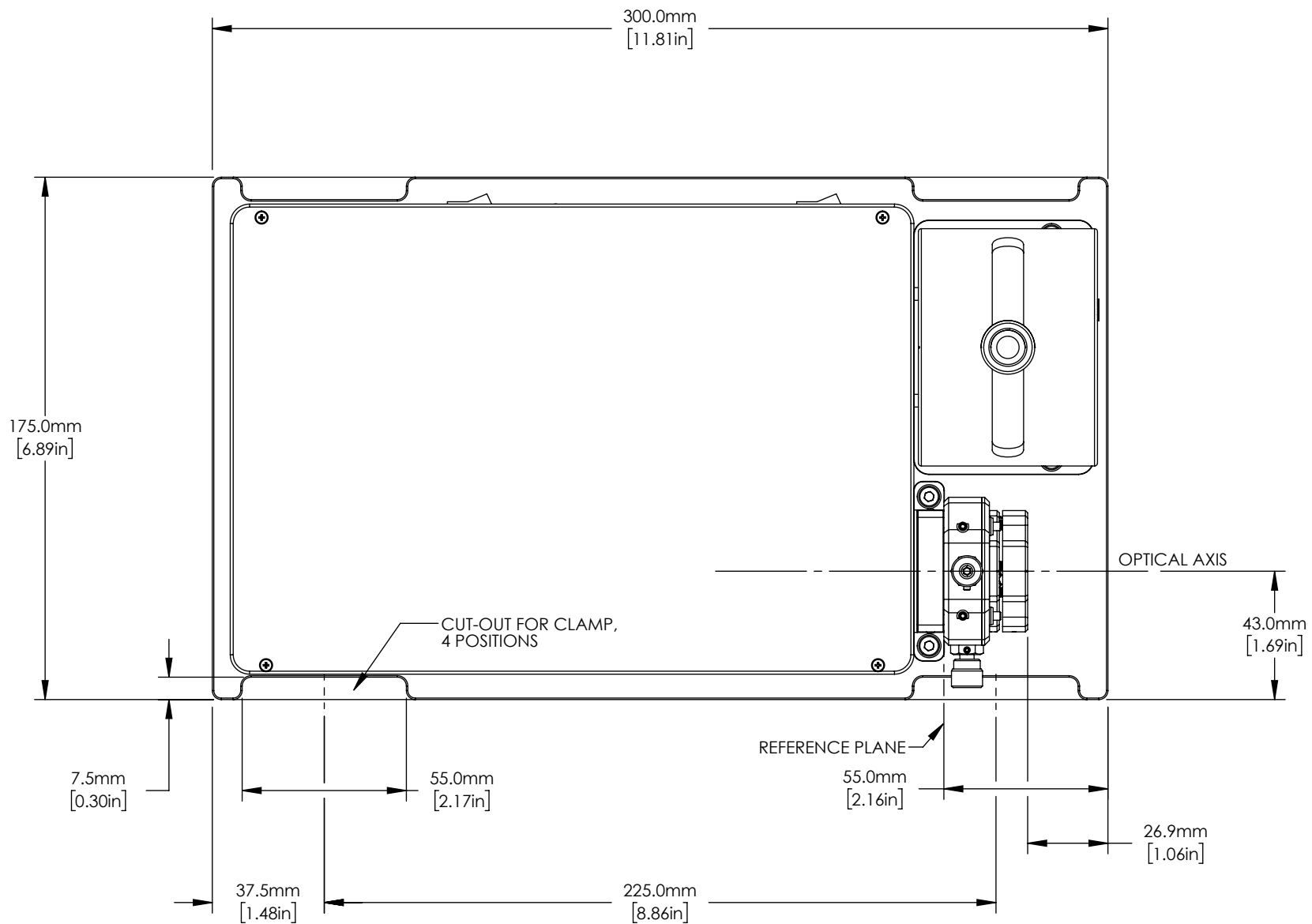

FOR INFORMATION ONLY
NOT FOR MANUFACTURING PURPOSES

DRAWING PROJECTION			THORLABS www.thorlabs.com	
NAME	DATE	M ² MEASUREMENT SYSTEM WITH BP209-IR2/M, 900-2700nm, METRIC		
DRAWN	Hit.	12/JUN/17	MATERIAL	REV
APPROVAL	RR	12/JUN/17	N/A	A
COPYRIGHT © 2017 BY THORLABS			ITEM #	APPROX WEIGHT
VALUES IN PARENTHESIS ARE CALCULATED AND MAY CONTAIN ROUND-OFF ERRORS			M2MS-BP209IR2/M	4.6 kg

91.2mm
[3.59in]

OPTICAL AXIS

70.0mm
[2.75in]

0.5mm
[0.02in]

BASE PLATE FOOT, 0.5mm
HEIGHT, 4 POSITIONS

DETAIL A
SCALE 1 : 1

250.0mm
[9.84in]

25.0mm
[0.98in]

M6x1mm, 10mm DEPTH, 5 POSITIONS,
FOR RUBBER DAMPING FEET THORLABS
ITEM RDF1 (4 PIECES INCLUDED)

125.0mm
[4.92in]

FOR INFORMATION ONLY
NOT FOR MANUFACTURING PURPOSES

DRAWING
PROJECTION



NAME

DATE

DRAWN

Hit.

12/JUN/17

APPROVAL

RR

12/JUN/17

COPYRIGHT © 2017 BY THORLABS

VALUES IN PARENTHESIS ARE CALCULATED
AND MAY CONTAIN ROUND OFF ERRORS

THORLABS

www.thorlabs.com

M² MEASUREMENT SYSTEM WITH
BP209-IR2/M, 900-2700nm, METRIC

MATERIAL

N/A

REV

A

ITEM #

M2MS-BP209IR2/M

APPROX WEIGHT

4.6 kg

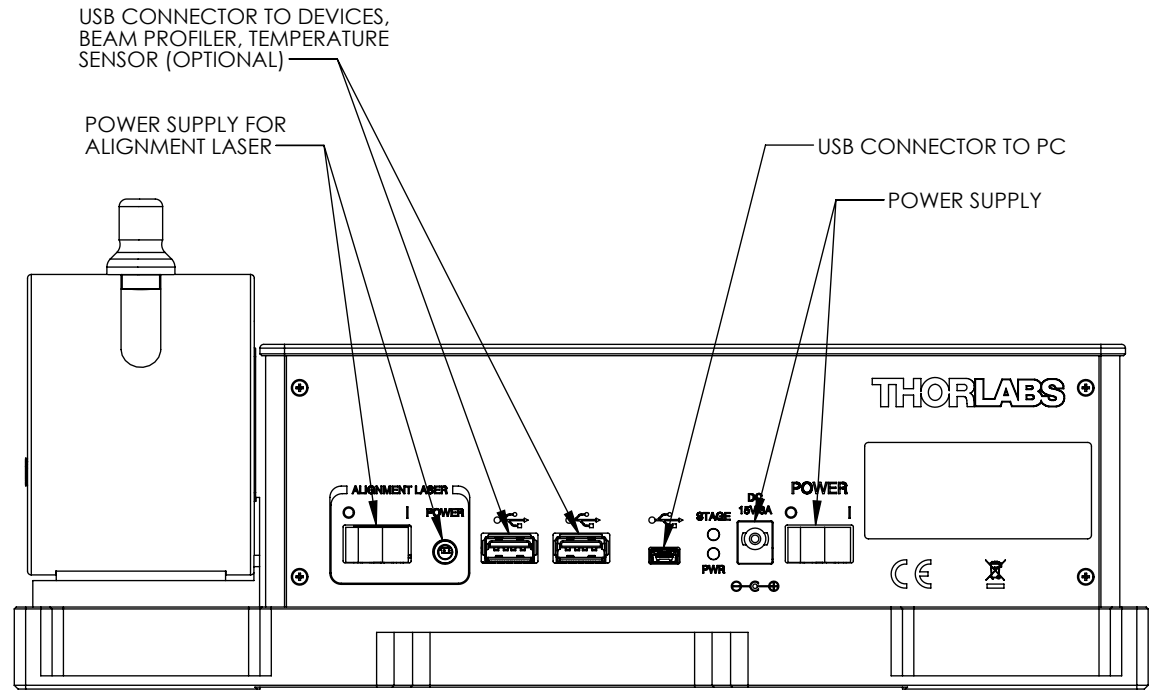
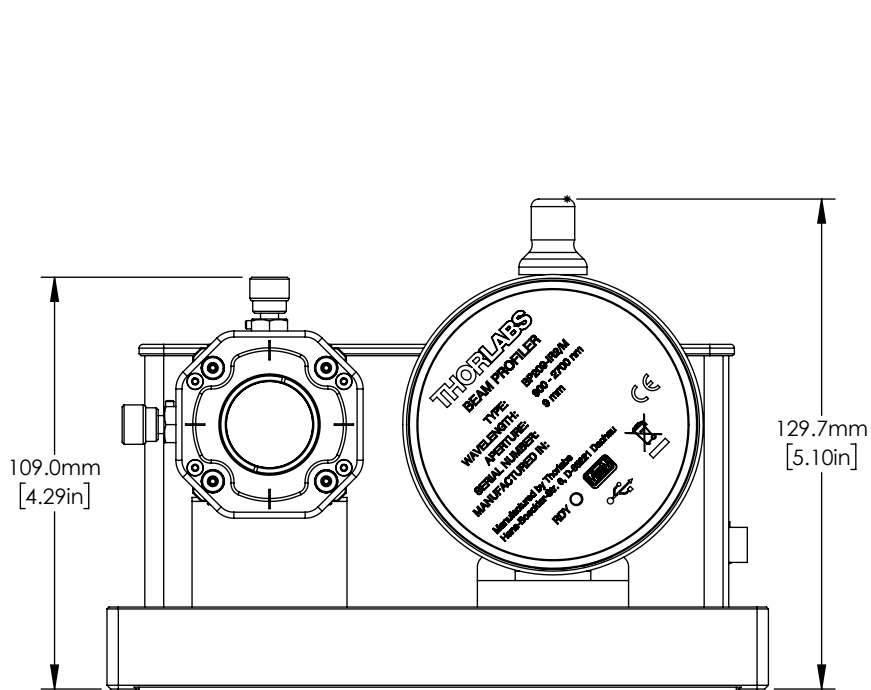

FOR INFORMATION ONLY
 NOT FOR MANUFACTURING PURPOSES

DRAWING PROJECTION			THORLABS www.thorlabs.com	
NAME	DATE	M ² MEASUREMENT SYSTEM WITH BP209-IR2/M, 900-2700nm, METRIC		
DRAWN	Hit.	12/JUN/17	MATERIAL	REV
APPROVAL	RR	12/JUN/17	N/A	A
COPYRIGHT © 2017 BY THORLABS				
VALUES IN PARENTHESIS ARE CALCULATED AND MAY CONTAIN ROUND OFF ERRORS		ITEM #	APPROX WEIGHT	
		M2MS-BP209IR2/M	4.6 kg	