

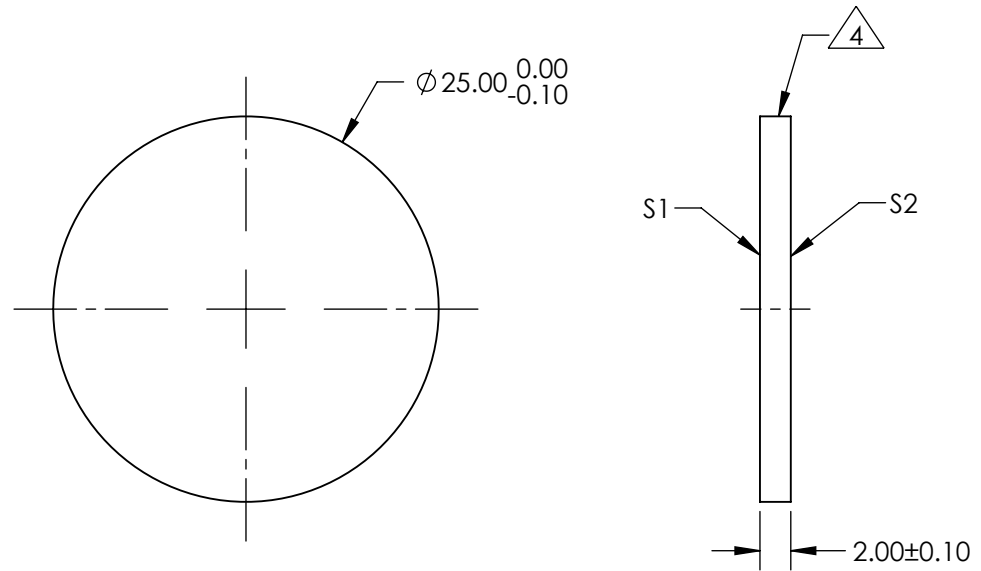

NOTES:

1. SUBSTRATE MATERIAL:
OPTICAL GRADE GERMANIUM
2. SURFACE S2 TO BE PARALLEL TO SURFACE S1 WITHIN 1 ARCMIN
3. COATING (APPLY ACROSS CLEAR APERTURE)
S1 & S2: R(AVG) < 3% FROM 3.0 TO 5.0 μm
4. FINE GROUND SURFACE
5. PROTECTIVE BEVEL AS NEEDED



**FOR INFORMATION ONLY:
DO NOT MANUFACTURE
PARTS TO THIS DRAWING**

SPECIFICATIONS SUBJECT TO CHANGE WITHOUT NOTICE
DIMENSIONS ARE FOR REFERENCE ONLY

	S1	S2	 Edmund Optics®		TITLE	25mm Dia. x 2.0mm Thick 3-5 μm AR Coating, Ge Window	SHEET 1 OF 1
SHAPE	PLANO	PLANO			DWG NO	89564	
SURFACE ACCURACY AT 10.6 μm (P-V)	1/10 WAVE	1/10 WAVE			ALL DIMS IN	mm	
SURFACE QUALITY	60 - 40	60 - 40					
MIN CLEAR APERTURE	ϕ 22.5	ϕ 22.5					