

NOTES:

1. SUBSTRATE:
N-BK7
2. S2 TO BE PARALLEL WITH S1 TO <1 ARCMIN
3. COATING (APPLY ACROSS CLEAR APERTURE)
S1 & S2: RAVG ≤0.4% @ 425 - 675nm

4. FINE GRIND SURFACE

5. RoHS COMPLIANT

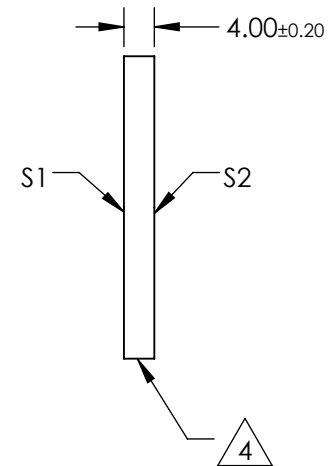
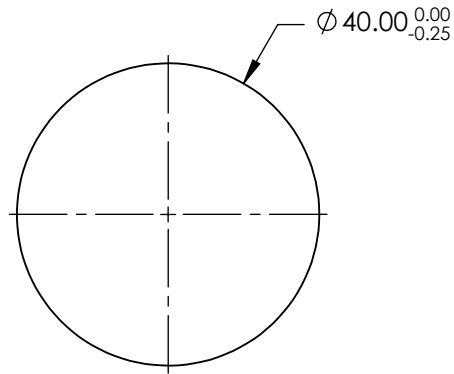
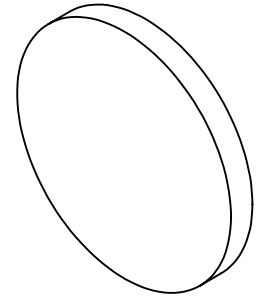

**FOR INFORMATION ONLY:
DO NOT MANUFACTURE
PARTS TO THIS DRAWING**

SPECIFICATIONS SUBJECT TO CHANGE WITHOUT NOTICE
DIMENSIONS ARE FOR REFERENCE ONLY

	S1	S2
SHAPE	PLANO	PLANO
SURFACE QUALITY	60-40	60-40
CLEAR APERTURE	Ø36.00	Ø36.00
BEVEL	PROTECTIVE AS NEEDED	PROTECTIVE AS NEEDED

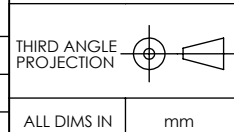

EO® Edmund Optics®

TITLE	40mm DIA., 4mm THICK, VIS 0° COATED λ/4 N-BK7 WINDOW		
DWG NO	47522	SHEET	1 OF 1