

NOTES:

**FOR INFORMATION ONLY:
DO NOT MANUFACTURE
PARTS TO THIS DRAWING**

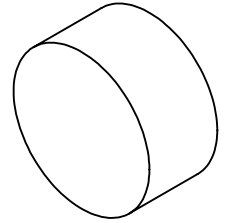

1. SUBSTRATE:FUSED SILICA
2. SURFACE S2 TO BE PARALLEL WITH SURFACE S1 TO WITHIN <3 <3 ARCMIN
3. COATING (APPLY ACROSS COATING APERTURE):
 S1: R(ABS) > 99% @ 1064nm
 T(ABS) > 95% @ 355nm @ 45° AOI

 DAMAGE THRESHOLD (PULSED):
 7.5 J/cm² @ 20ns , 20 Hz @ 1064nm
 2.5 J/cm² @ 20ns , 20 Hz @ 355nm

 S2: R(ABS) < 0.25% @ 355nm @ 45° AOI

 DAMAGE THRESHOLD (PULSED):
 7.5 J/cm² @ 20ns , 20 Hz @ 355nm

FINE GRIND SURFACE

5. ROHS COMPLIANT

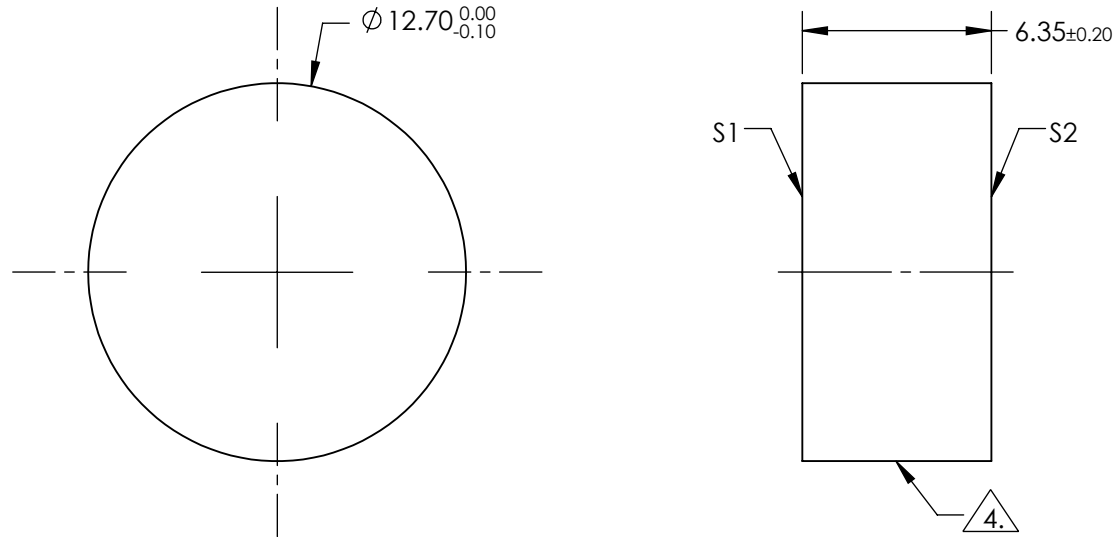

SPECIFICATIONS SUBJECT TO CHANGE WITHOUT NOTICE
DIMENSIONS ARE FOR REFERENCE ONLY

Edmund Optics®

	S1	S2
SHAPE	PLANO	PLANO
SURFACE QUALITY	10-5	10-5
CLEAR APERTURE	Ø10.80	Ø10.80
BEVEL	PROTECTIVE AS NEEDED	PROTECTIVE AS NEEDED

THIRD ANGLE
PROJECTION

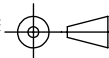

ALL DIMS IN

mm

TITLE

Ø12.7mm HS 532, 1064R/355T HARMONIC
BEAMSPLITTER

DWG NO

37714

SHEET
1 OF 1