

NOTES:

1. SUBSTRATE: FUSED SILICA
2. RoHS: COMPLIANT
3. SURFACE S2 TO BE PARALLEL TO SURFACE S1 TO WITHIN < 5 ARCMIN
4. COATING (APPLY ACROSS COATING APERTURE)
 S1 & S2: R(ABS) ≤ 1.0% FROM 350 - 450nm
 R(AVG) ≤ 1.5% FROM 250 - 700nm

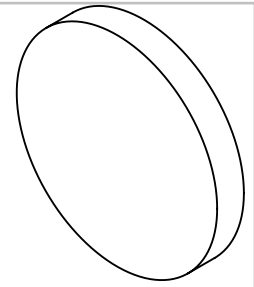

5. FINE GRIND SURFACE

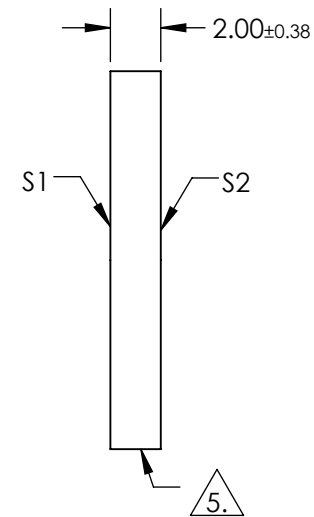
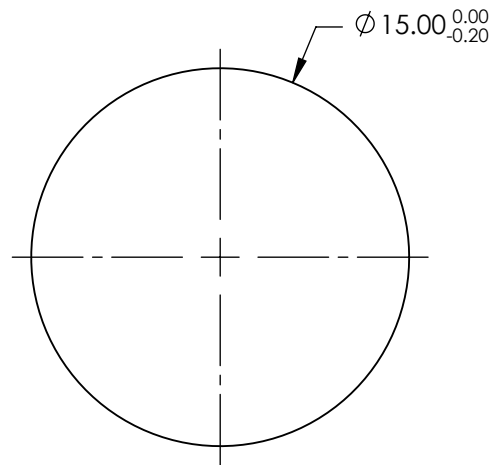

**FOR INFORMATION ONLY:
DO NOT MANUFACTURE
PARTS TO THIS DRAWING**

SPECIFICATIONS SUBJECT TO CHANGE WITHOUT NOTICE
DIMENSIONS ARE FOR REFERENCE ONLY

	S1	S2
SHAPE	PLANO	PLANO
SURFACE ACCURACY	1λ	1λ
SURFACE QUALITY	60-40	60-40
CLEAR APERTURE	Ø13.50	Ø13.50
BEVEL	PROTECTIVE AS NEEDED	PROTECTIVE AS NEEDED

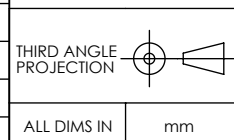

TITLE	15mm DIA. UV - VIS COATED, 1λ FUSED SILICA WINDOW
DWG NO	84473
SHEET 1 OF 1	