



PDA10A2 **Si Amplified Fixed Gain** **Detector**

User Guide



















Table of Contents

Chapter 1	Warning Symbol Definitions	1
Chapter 2	Description.....	2
Chapter 3	Setup.....	3
Chapter 4	Operation.....	4
	4.1. <i>Theory of Operation</i>	4
	4.2. <i>Responsivity</i>	4
	4.3. <i>Dark Current</i>	4
	4.4. <i>Bandwidth and Response</i>	5
	4.5. <i>Terminating Resistance</i>	5
Chapter 5	Troubleshooting	6
Chapter 6	Specifications	7
	6.1. <i>Response Curve</i>	9
	6.2. <i>Mechanical Drawing</i>	10
Chapter 7	Certificate of Conformance	11
Chapter 8	Regulatory	12
Chapter 9	Thorlabs Worldwide Contacts.....	13

Chapter 1 Warning Symbol Definitions

Below is a list of warning symbols you may encounter in this manual or on your device.

Symbol	Description
	Direct Current
	Alternating Current
	Both Direct and Alternating Current
	Earth Ground Terminal
	Protective Conductor Terminal
	Frame or chassis Terminal
	Equipotentiality
	On (Supply)
	Off (Supply)
	In Position of a Bi-Stable Push Control
	Out Position of a Bi-Stable Push Control
	Caution, Risk of Electric Shock
	Caution, Hot Surface
	Caution, Risk of Danger
	Warning, Laser Radiation
	Caution: ESD Sensitive Components

Chapter 2 Description

The PDA10A2 is an amplified, silicon detector designed for detection of light signals ranging from 200 to 1100 nm. A buffered output drives 50 Ω load impedances up to 5 V. The PDA10A2 housing includes a removable threaded coupler (SM1T1) and retainer ring (SM1RR) that is compatible with any number of Thorlabs 1" threaded accessories. This allows convenient mounting of external optics, light filters, apertures, as well as providing an easy mounting mechanism using Thorlabs' cage assembly accessories.



ESD Caution



The components inside this instrument are ESD sensitive. Take all appropriate precautions to discharge personnel and equipment before making any electrical connections to the unit.



Caution!



Long-term exposure to high-energy UV light may degrade the performance and specifications of this Si detector.

Chapter 3 Setup

The detector can be set up in many different ways using our extensive line of adapters. However, the detector should always be mounted and secured for best operation.

1. Unpack the optical head, install either an imperial or metric optical post into one of the mounting holes located on the bottom and side of the sensor, and mount using a post holder. Note that these detectors feature tapped holes that accept both 8-32 and M4 threads, so using either imperial or metric TR posts is possible.
2. Connect the power supply 3-pin plug into the power receptacle on the PDA10A2.
3. Plug the power supply into a 50 to 60Hz, 100 V / 120 V / 230 V power outlet.
4. Attach a 50 Ω coax cable (i.e. RG-58U) to the output of the PDA. When running cable lengths longer than 12" we recommend terminating the opposite end of the coax with a 50 Ω resistor (Thorlabs p/n T4119) for maximum performance. Connect the remaining end to a measurement device such as an oscilloscope or high speed DAQ card. Caution: Many high speed oscilloscopes have input impedances of 50 Ω . In this case, do not install a 50 Ω terminator. The combined loads will equal 25 Ω which could allow ~135 mA of output current. This will damage the output driver of the PDA10A2.
5. Power the PDA10A2 on using the power switch located on the top side of the unit.



Caution!



The PDA10A2 was designed to allow maximum accessibility to the photodetector by having the active area surface of the diode flush with the outside of the PDA housing. When using fiber adapters, make sure that the fiber ferrule does not crash into the detector. Failure to do so may cause damage to the diode and/or the fiber.

6. Install any desired filters, optics, adapters, or fiber adapters to the input aperture.
7. During alignment, take appropriate precautions, such as using reduced radiation power, or other precautions, and use proper eye and/or skin protection as recommended by the radiation source manufacturer.
8. Apply a light source to the detector.

Chapter 4 Operation

4.1. Theory of Operation

Thorlabs PDA series are ideal for measuring both pulsed and CW light sources. The PDA10A2 includes a reverse-biased PIN photo diode, mated to a fixed gain transimpedance amplifier, and packaged in a rugged housing.

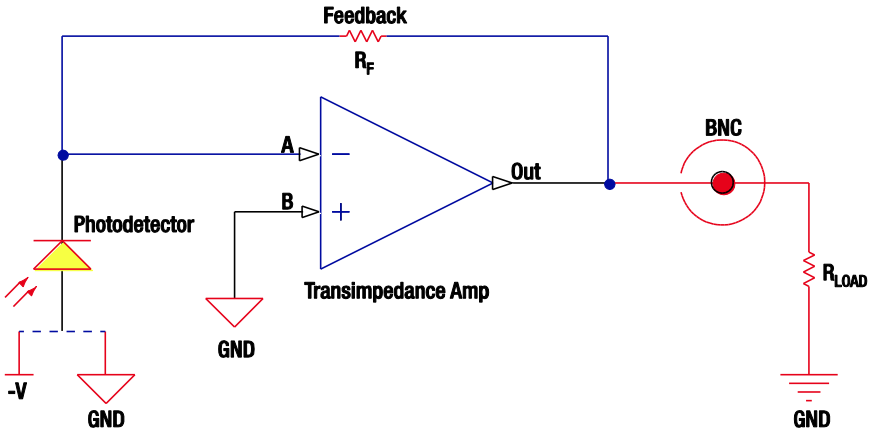

4.2. Responsivity

The responsivity of a photodiode can be defined as a ratio of generated photocurrent (I_{PD}) to the incident light power (P) at a given wavelength:

$$R(\lambda) = \frac{I_{PD}}{P}$$

4.3. Dark Current

Dark current is leakage current which flows when a bias voltage is applied to a photodiode. The PDA with Transimpedance Amplifier does control the dark current flowing out. Looking at the figure above, it can be noted that Point B is held at ground and the amplifier will try to hold point A to “Virtual Ground”. This minimizes the effects of dark current present in the system.

The dark current present is also affected by the photodiode material and the size of the active area. Silicon devices generally produce low dark current compared to germanium devices which have high dark currents. The table below lists several photodiode materials and their relative dark currents, speeds, sensitivity, and costs. Please note that sensitivity values in the table are typical values; Thorlabs offers photodetectors with sensitivity ranges that vary from those shown below.

Material	Dark Current	Speed	Sensitivity ¹	Cost
Silicon (Si)	Low	High	400 - 1000 nm	Low
Germanium (Ge)	High	Low	900 - 1600 nm	Low
Gallium Phosphide (GaP)	Low	High	150 - 550 nm	Med
Indium Gallium Arsenide (InGaAs)	Low	High	800 - 1800 nm	Med
Extended Range: Indium Gallium Arsenide (InGaAs)	High	High	1200 - 2600 nm	High

4.4. Bandwidth and Response

For the PDA detectors, the gain of the detector is dependent on the feedback element (R_f). The bandwidth of the detector can be calculated using the following:

$$f(-3dB) = \sqrt{\frac{GBP}{4\pi R_f \times C_D}}$$

Where GBP is the amplifier gain bandwidth product and C_D is the sum of the photodiode junction capacitance and the amplifier capacitance.

4.5. Terminating Resistance

The maximum output of the PDA10A2 is 10 volts for high impedance loads (i.e. $R_{Load} > 5 \text{ k}\Omega$) and 5 V for 50 Ω loads. Adjust the gain so that the measured signal level out of the PDA10A2 is below 10 V (5 V with a 50 Ω load) to avoid saturation.

For low terminating resistors, <5 k Ω or 1% error, an additional factor needs to be considered. The output of the PDA includes a 50 Ω series resistor (R_s). The output load creates a voltage divider with the 50 Ω series resistor as follows:

$$Scale\ Factor = \frac{R_{Load}}{R_{Load} + R_s}$$

$$V_{OUT} = \mathcal{R}(\lambda) * Transimpedance\ Gain * Scale\ Factor * Input\ Power\ (W)$$

Note that we already include the scale factor in our specification for the gain at 50 Ω . Refer to the table in Chapter 6 for additional performance specifications.

¹ Approximate values; actual wavelength values will vary.

Chapter 5 Troubleshooting

Problem	Suggested Solutions
There is no signal response.	Verify that the power is switched on and all connections are secure.
	Verify the proper terminating resistor is installed if using a Voltage measurement device.
	Verify that the optical signal wavelength is within the specified wavelength range.
	Verify that the optical signal is illuminating the detector active area.
Output Voltage will not increase. Detector Output is skewed.	Check to make sure the detector is not saturated. Refer to the Output Voltage spec. in the Specifications table.
	Install a 1" Lens Tube (SM1L10) to the thread coupler (SM1T1) to baffle any external light sources to see if this improves the response.

Chapter 6 Specifications

All performance specifications are typical, performed at 25 °C ambient temperature, and assume a 50 Ω load, unless stated otherwise.

Electrical Specifications ²		
Detector	-	Si
Active Area	-	Ø1 mm (0.8 mm ²)
Wavelength Range ³	λ	200 to 1100 nm
Peak Wavelength	λ_p	730 nm (Typ)
Peak Response	$\Re(\lambda_p)$	0.44 A/W (Typ)
Small Signal Bandwidth	-	150 MHz
NEP (λ_p)	W/√Hz	2.92×10^{-11}
Noise (RMS)	-	1.5 mVrms
Max Output Current	I_{OUT}	100 mA
Dark Offset	-	±10 mV
Load Impedance	-	50 Ω to Hi-Z
Transimpedance Gain	-	5×10^3 V/A (50 Ω) 1×10^4 V/A (Hi-Z)
Output Voltage	V_{OUT}	0 to 5 V (50 Ω) 0 to 10 V (Hi-Z)

² The PDA10A2 has a 50 Ω series terminator resistor (i.e. in series with amplifier output). This forms a voltage divider with any load impedance (e.g. 50 Ω load divides signal in half).

³ When long-term UV light is applied, the product specifications may degrade. For example, the product's UV response may decrease and the dark current may increase. The degree to which the specifications may degrade is based upon factors such as the irradiation level, intensity, and usage time.

General	
On/Off Switch	Slide
Output	BNC (DC Coupled)
Package Size	2.79" x 1.96" x 0.89" (70.9 mm x 49.8 mm x 22.5 mm)
PD Surface Depth ⁴	0.09" (2.2 mm)
Weight, Detector Only	0.10 kg
Accessories	SM1T1 Coupler SM1RR Retainer Ring
Operating Temp	10 to 50 °C
Storage Temp	-25 to 70 °C
AC Power Supply	AC - DC Converter
Input Power ⁵	6 W 100 V / 120 V / 230 V, 50 - 60 Hz

⁴ Measured from the active area to the start of the threads on the housing body. The detector active area surface is flush with the front of the housing body.

⁵ Although the power supply is rated for 6 W, the detector's actual usage is <5 W over the full operating range.

6.1. Response Curve

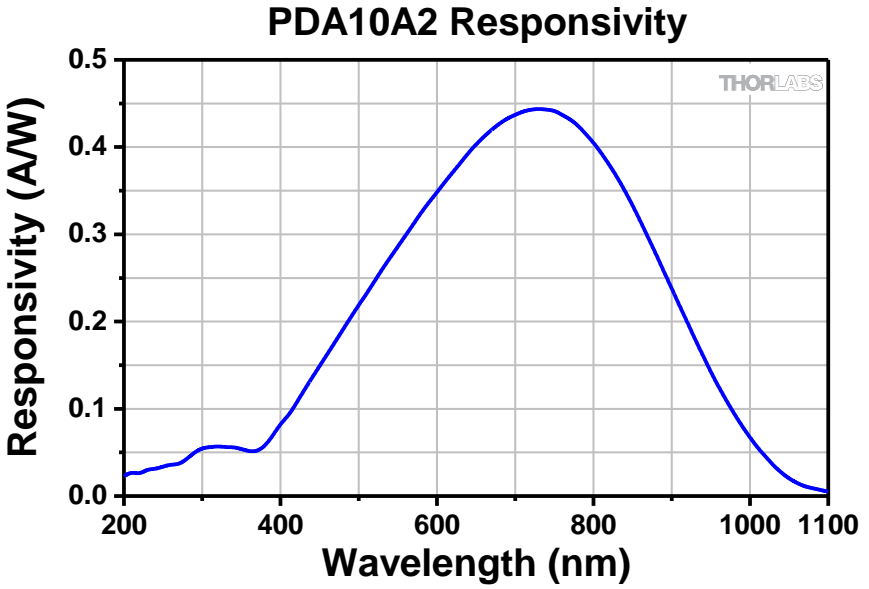

6.2. Mechanical Drawing

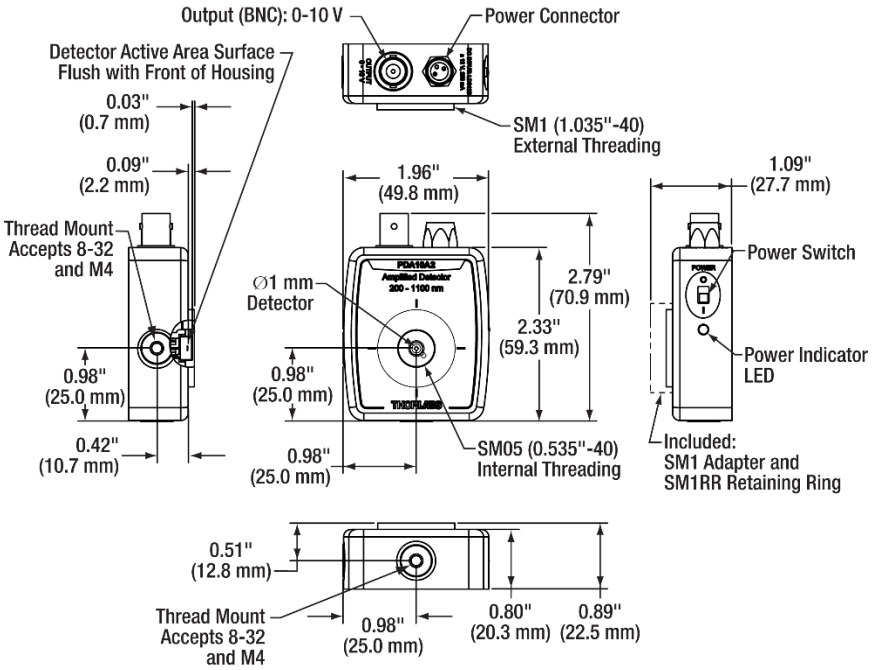

Chapter 7 Certificate of Conformance



THORLABS
www.thorlabs.com

EU Declaration of Conformity

in accordance with EN ISO 17050-1:2010

We: Thorlabs Inc.
Of: 56 Sparta Avenue, Newton, New Jersey, 07860, USA

in accordance with the following Directive(s):

2014/35/EU	Low Voltage Directive (LVD)
2014/30/EU	Electromagnetic Compatibility (EMC) Directive
2011/65/EU	Restriction of Use of Certain Hazardous Substances (RoHS)

hereby declare that:

Model: **PDA05CF2, PDA100A2, PDA10A2, PDA10CS2, PDA10D2, PDA20CS2, PDA25K2, PDA30B2, PDA36A2, PDA50B2, PDA8A2, PDA20C2**

Equipment: **Switchable adjustable and Non-switchable fixed gain Amplified Photodetector**

is in conformity with the applicable requirements of the following documents:

EN 61010-1	Safety Requirements for Electrical Equipment for Measurement, Control and Laboratory Use.	2010
EN 61326-1	Electrical Equipment for Measurement, Control and Laboratory Use - EMC Requirements	2013

and which, issued under the sole responsibility of Thorlabs, is in conformity with Directive 2011/65/EU of the European Parliament and of the Council of 8th June 2011 on the restriction of the use of certain hazardous substances in electrical and electronic equipment, for the reason stated below:

does not contain substances in excess of the maximum concentration values tolerated by weight in homogenous materials as listed in Annex II of the Directive

I hereby declare that the equipment named has been designed to comply with the relevant sections of the above referenced specifications, and complies with all applicable Essential Requirements of the Directives.

Signed:  On: 09 January 2018

Name: Ann Strachan
Position: Compliance Manager

EDC - PDA05CF2, PDA100A2, PDA10A2, P...



Chapter 8 Regulatory

As required by the WEEE (Waste Electrical and Electronic Equipment Directive) of the European Community and the corresponding national laws, Thorlabs offers all end users in the EC the possibility to return “end of life” units without incurring disposal charges.

- This offer is valid for Thorlabs electrical and electronic equipment:
- Sold after August 13, 2005
- Marked correspondingly with the crossed out “wheelie bin” logo (see right)
- Sold to a company or institute within the EC
- Currently owned by a company or institute within the EC
- Still complete, not disassembled and not contaminated

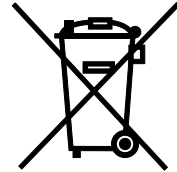

Wheelie Bin Logo

As the WEEE directive applies to self contained operational electrical and electronic products, this end of life take back service does not refer to other Thorlabs products, such as:

- Pure OEM products, that means assemblies to be built into a unit by the user (e.g. OEM laser driver cards)
- Components
- Mechanics and optics
- Left over parts of units disassembled by the user (PCB’s, housings etc.).

If you wish to return a Thorlabs unit for waste recovery, please contact Thorlabs or your nearest dealer for further information.

Waste Treatment is Your Own Responsibility

If you do not return an “end of life” unit to Thorlabs, you must hand it to a company specialized in waste recovery. Do not dispose of the unit in a litter bin or at a public waste disposal site.

Ecological Background

It is well known that WEEE pollutes the environment by releasing toxic products during decomposition. The aim of the European RoHS directive is to reduce the content of toxic substances in electronic products in the future.

The intent of the WEEE directive is to enforce the recycling of WEEE. A controlled recycling of end of life products will thereby avoid negative impacts on the environment.

Chapter 9 Thorlabs Worldwide Contacts

For technical support or sales inquiries, please visit us at www.thorlabs.com/contact for our most up-to-date contact information.



USA, Canada, and South America

Thorlabs, Inc.
sales@thorlabs.com
techsupport@thorlabs.com

Europe

Thorlabs GmbH
europe@thorlabs.com

France

Thorlabs SAS
sales.fr@thorlabs.com

Japan

Thorlabs Japan, Inc.
sales@thorlabs.jp

UK and Ireland

Thorlabs Ltd.
sales.uk@thorlabs.com
techsupport.uk@thorlabs.com

Scandinavia

Thorlabs Sweden AB
scandinavia@thorlabs.com

Brazil

Thorlabs Vendas de Fotônicos Ltda.
brasil@thorlabs.com

China

Thorlabs China
chinasales@thorlabs.com



THORLABS
www.thorlabs.com
