THORLABS

DET01CFC(/M)

**Fiber Input
InGaAs Biased Detector**

User Guide



















Table of Contents

Chapter 1	Warning Symbol Definitions	1
Chapter 2	Description	2
Chapter 3	Setup	3
Chapter 4	Operation	4
4.1.	<i>Theory of Operation</i>	4
4.2.	<i>Responsivity</i>	4
4.3.	<i>Modes of Operation</i>	4
4.4.	<i>Dark Current</i>	5
4.5.	<i>Junction Capacitance</i>	6
4.6.	<i>Bandwidth and Response</i>	6
4.7.	<i>Terminating Resistance</i>	7
4.8.	<i>Shunt Resistance</i>	7
4.9.	<i>Series Resistance</i>	7
4.10.	<i>Damage Threshold</i>	7
4.11.	<i>Battery Replacement</i>	8
Chapter 5	Common Operating Circuits	9
Chapter 6	Troubleshooting	11
Chapter 7	Specifications	12
7.1.	<i>Response Curve</i>	13
7.2.	<i>Mechanical Drawing</i>	14
Chapter 8	Certificate of Conformance	15
Chapter 9	Regulatory	16
Chapter 10	Thorlabs Worldwide Contacts	17

Chapter 1 Warning Symbol Definitions

Below is a list of warning symbols you may encounter in this manual or on your device.

Symbol	Description
	Direct Current
	Alternating Current
	Both Direct and Alternating Current
	Earth Ground Terminal
	Protective Conductor Terminal
	Frame or chassis Terminal
	Equipotentiality
	On (Supply)
	Off (Supply)
	In Position of a Bi-Stable Push Control
	Out Position of a Bi-Stable Push Control
	Caution: Risk of Electric Shock
	Caution: Hot Surface
	Caution: Risk of Danger
	Warning: Laser Radiation
	Caution: ESD Sensitive Components

Chapter 2 Description

The DET01CFC is a ready-to-use, high-speed InGaAs photodetector for use with FC/PC connectorized fiber optic cables in NIR optical systems. The unit comes with an FC/PC bulkhead connector, detector, and 12 V bias battery enclosed in a compact aluminum housing. The FC/PC connector provides easy coupling to fiber-based light sources. The output uses an SMA jack to minimize size and maximize frequency response. The maximum bandwidth is 1.2 GHz and the detector will operate over the 800-1700 nm spectral range. A visible version, the DET02AFC, is also available and operates in the 400-1100 nm spectral range.



ESD Caution



The components inside this instrument are ESD sensitive. Take all appropriate precautions to discharge personnel and equipment before making any electrical connections to the unit.

Chapter 3 Setup

The detector can be set up in many different ways using our extensive line of adapters. However, the detector should always be mounted and secured for best operation. Step 1 in the setup instructions below outline how to mount the detector onto a post.

1. Unpack the optical head, install a Thorlabs TR-series $\frac{1}{2}$ " diameter post into one of the #8-32 (M4 on /M version) tapped hole, located on the bottom and side of the sensor, and mount into a PH-series post holder.
2. Attach a 50 Ω SMA to Coax cable (i.e. CA28xx) to the output of the DET. Select and install a terminating resistor to the remaining end of the cable (BNC Side), and connect to a voltage measurement device. See Chapter 4, page 7 to determine resistor values. Thorlabs sells a 50 Ω terminator (T4119) for best frequency performance and a variable terminator (VT2) for output voltage flexibility. Note the input impedance of your measurement device since this will act as a terminating resistor. A load resistor is not necessary when using current measurement devices.
3. During alignment, take appropriate precautions, such as using reduced radiation power, or other precautions, and use proper eye and/or skin protection as recommended by the radiation source manufacturer.
4. Apply a light source to the detector.

Chapter 4 Operation

4.1. Theory of Operation

A junction photodiode is an intrinsic device, which behaves similarly to an ordinary signal diode, but it generates a photocurrent when light is absorbed in the depleted region of the junction semiconductor. A photodiode is a fast, linear device that exhibits high quantum efficiency based upon the application used in a variety of different applications.

It is necessary to be able to determine correctly the level of the output current to expect and the responsivity based upon the incident light. Depicted in Figure 1 is a junction photodiode model with basic discrete components to help visualize the main characteristics and gain a better understanding of the operation of Thorlabs' photodiodes.

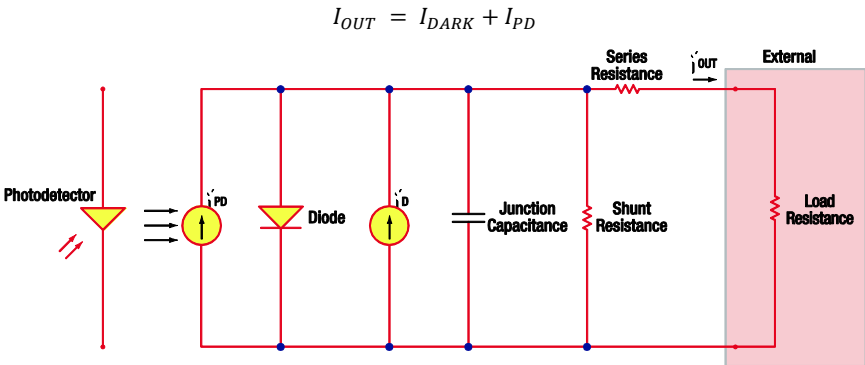

Figure 1 Photodiode Model

4.2. Responsivity

The definition of photodiode responsivity is the ratio of generated photocurrent (I_{PD}) to the incident light power (P) at a given wavelength:

$$R(\lambda) = \frac{I_{PD}}{P}$$

4.3. Modes of Operation

The photodiode can operate in one of two modes: photoconductive (reverse bias) or photovoltaic (zero-bias). Mode selection depends upon the applications speed requirements and the amount of tolerable dark current (leakage current).

Photoconductive

In photoconductive mode a reverse external bias is applied, which is the basis for our DET series detectors. The current measured through the circuit indicates illumination of the device; the measured output current is linearly proportional to the input optical power. Applying a reverse bias increases the width of the depletion junction producing an increased responsivity with a decrease in junction capacitance and produces a linear response. Operating under these conditions does tend to produce a larger dark current but this can be limited based upon the photodiode material. (Note: The DET detectors are reverse biased and cannot be operated under a forward bias.)

Note

The DET detectors are reverse biased and cannot be operated under forward bias conditions.

Photovoltaic

In photovoltaic mode, the photodiode is zero biased. The flow of current out of the device is restricted and a voltage builds up. This mode of operation exploits the photovoltaic effect, which is the basis for solar cells. When operating in photovoltaic mode the amount of dark current is at a minimum setting.

4.4. Dark Current

When we apply bias voltage to a photodiode, produces a leakage current called dark current. Photoconductive mode tends to generate a higher dark current that varies directly with temperature. It infers that, dark current can approximately double for every 10 °C increase in temperature, and shunt resistance can double for every 6 °C rise. Of course, applying a higher bias will decrease the junction capacitance but will increase the amount of dark current present.

The photodiode material and the size of the active area also affect the dark current present. Silicon devices generally produce low dark current compared to germanium devices, which have high dark currents. The table below lists several photodiode materials and their relative dark currents, speeds, sensitivity, and costs.

The table below gives some advantages to each common type of detector material.

Material	Dark Current	Speed	Sensitivity ^a (nm)	Cost
Silicon (Si)	Low	High	400 – 1000	Low
Germanium (Ge)	High	Low	900 – 1600	Low
Gallium Phosphide (GaP)	Low	High	150 – 550	Med
Indium Gallium Arsenide (InGaAs)	Low	High	800 – 1800	Med
Extended Range: Indium Gallium Arsenide (InGaAs)	High	High	1200 – 2600	High

4.5. Junction Capacitance

Junction capacitance (C_j) is an important property of a photodiode as this can have a profound impact on the bandwidth and the response of a photodiode. It reaffirms that larger diode areas encompass a greater junction volume with increased charge capacity. In a reverse bias application, the depletion width of the junction increases, thus effectively reducing the junction capacitance and increasing the response speed.

4.6. Bandwidth and Response

A load resistor will react with the photodetector junction capacitance to limit the bandwidth. For best frequency response, a 50 Ω terminator should be used in conjunction with a 50 Ω coaxial cable. The bandwidth (f_{BW}) and the rise time response (t_r) can be approximated using the junction capacitance and the load resistance (R_{LOAD}):

$$f_{BW} = \frac{1}{(2\pi R_{LOAD} \times C_j)}$$

$$t_r = \frac{0.35}{f_{BW}}$$

^a Approximate values, actual wavelength values will vary from unit to unit.

4.7. Terminating Resistance

We use a load resistance convert the generated photocurrent into a voltage (V_{OUT}) for viewing on an oscilloscope:

$$V_{OUT} = I_{OUT} \times R_{LOAD}$$

Depending on the type of the photodiode, load resistance can affect the response speed. For maximum bandwidth, we recommend using a 50 Ω coaxial cable with a 50 Ω terminating resistor at the opposite end of the cable. This will minimize ringing by matching the cable with its characteristic impedance. If bandwidth is not important, you may increase the amount of voltage for a given light level by increasing R_{LOAD} . In an unmatched termination, the length of the coaxial cable can have a profound impact on the response, thus is recommendable to keep the cable as short as possible.

4.8. Shunt Resistance

Shunt resistance represents the resistance of the zero-biased photodiode junction. An ideal photodiode will have an infinite shunt resistance, but actual values may range from the order of ten Ω to thousands of $M\Omega$ and is dependent on the photodiode material. For example, and InGaAs detector has a shunt resistance in the order of 10 $M\Omega$ while a Ge detector is in the $k\Omega$ range. This can significantly affect the noise current on the photodiode. For most applications, however, the high resistance produces little effect and most of the time ignored.

4.9. Series Resistance

Series resistance models the resistance of the semiconductor material, and we ignore this low resistance. The series resistance arises from the contacts and the wire bonds of the photodiode; this mainly determines the linearity of the photodiode under zero bias conditions.

4.10. Damage Threshold

Exposure to an intense light source can easily damage a photodiode. One of the main characteristics of a damaged photodiode is the presence of increased dark current, along with burn spots on the detector active area. The damage threshold may vary from photodiode to photodiode, as this is generally dependent on material. Silicon devices tend to be more durable than InGaAs and can handle higher energy levels.

The formula below calculates the energy of each pulse, using the average power and the repetition rate. If the pulse width is given, the peak power can also be determined.

$$Pulse_{Energy} (J) = Average Power (W) * T_{pulse} (s)$$

$$Peak Power (W) = \frac{Pulse_{Energy} (J)}{Pulse Width (s)}$$

4.11. Battery Replacement

Thorlabs delivers each DET with an A23 12 V battery installed. This battery is readily available at most retail stores, as well as through Thorlabs. The battery supplied will deliver about 40 hours with a 1 mA load, roughly equivalent to a continuous 1.5 mW light source at peak wavelength. When not light is applied, the supply current turns out to be very small and the battery hardly degrades.

Locate the battery cap directly above the output BNC. Unthread the cap and remove the battery. Install the new battery into the cap, negative side in, and thread back into the DET. Be careful not to cross thread the cap into the housing.

CAUTION: The DET does not include a protection diode to prevent damage if the installation of the battery is backwards. The battery direction is located on the housing.



Chapter 5 Common Operating Circuits

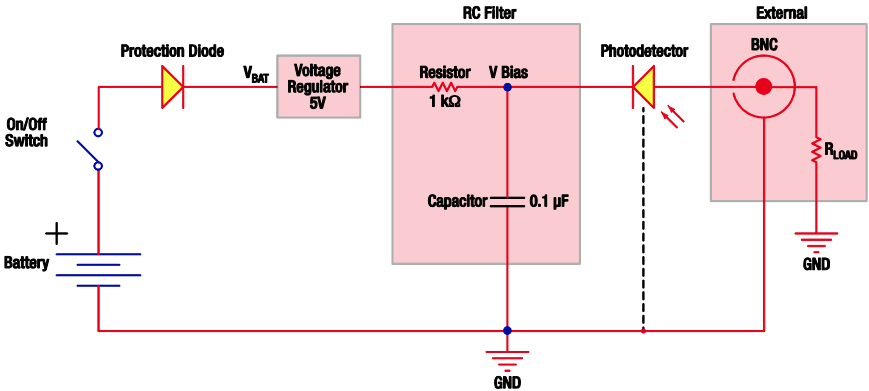

Figure 2 Basic DET Circuit

The DET Series Detectors are designed according to the circuit depicted above. The detector is reverse biased to produce a linear response with applied input light. The generated photocurrent is based upon the incident light and wavelength and can be viewed on the oscilloscope by attaching a load resistance on the output. The function of the RC Filter is to filter any high frequency noise from the input supply, which may contribute to a noisy output.

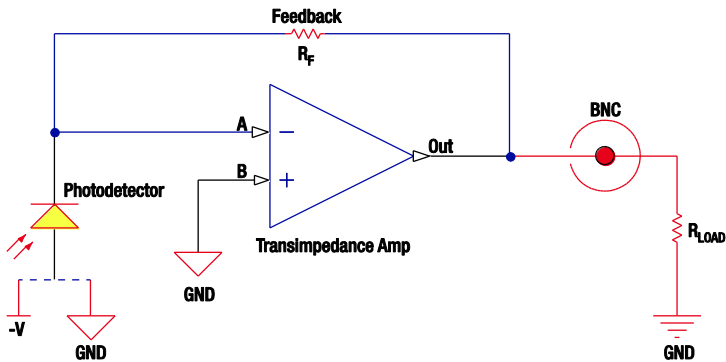

Figure 3 Amplified Detector

One can also use a photodetector with an amplifier for the purpose of achieving high gain. The user can choose whether to operate in Photovoltaic or Photoconductive modes. There are a few benefits of choosing this active circuit:

- Photovoltaic Mode: We maintain the circuit at zero volts across the photodiode, holding point A at the same potential as point B by the operational amplifier. This eliminates the possibility of dark current.
- Photoconductive mode: We reverse bias the photodiode; it improves the bandwidth while lowering the junction capacitance. The gain of the detector is dependent on the feedback element (R_F). The bandwidth of the detector can be calculated using the following:

$$f(-3dB) = \sqrt{\frac{GBP}{4\pi R_f \times C_D}}$$

Where GBP is the amplifier product gain-bandwidth and C_D is the sum of the junction capacitance, amplifier capacitance, and feedback capacitance.

Chapter 6 Troubleshooting

Problem	Suggested Solutions
<p>There is no signal response or response is slower than expected.</p>	Verify that the battery is inserted and has sufficient power (>9V)
	Verify the proper terminating resistor is installed if using a Voltage measurement device.
	Verify that the optical signal wavelength is within the specified wavelength range.
	Verify that the optical signal is illuminating the detector active area.
	Connect the DET to an oscilloscope without a terminating resistor installed. Most general purpose oscilloscopes will have a 1 MΩ input impedance. Point the detector toward a fluorescent light and verify that a 60 Hz (50 Hz outside the US) signal appears on the scope. If so the device should be operating properly and the problem may be with the light source or alignment.
<p>There is an AC signal present when the unit is turned off.</p>	The detector has an AC path to ground even with the switch in the OFF position. It is normal to see an output response to an AC signal with the switch in this state. However, because the detector is unbiased, operation in this mode is not recommended.
<p>The output appears AC coupled with long rise times and the power switch ON.</p>	This is usually an indication that the battery level is low and needs to be changed. See Battery Replacement Section for more details.
<p>Skewed Rise and Fall Times</p>	Check to see if the battery voltage is 9V or greater. Make sure you are not saturating the detector as this can lead to permanent damage.

Chapter 7 Specifications

All measurements performed at 25 °C unless stated otherwise.

Electrical Specifications		
Parameter	Symbol	Value
Detector	-	InGaAs PIN
Active Area Diameter	-	Ø0.12 mm
Wavelength Range	λ	800 to 1700 nm
Peak Wavelength	λ_p	1550 nm
Peak Response ^a	$\Re(\lambda_p)$	0.95 A/W (Typ.)
Diode Capacitance (12V)	C_J	2.4 pF
Bandwidth ^{a,b,c} (-3 dB)	-	1.2 GHz
Rise Time ^{a,b,c} @1310 nm	-	<1.0 ns
Fall Time ^{a,b,c} @1310 nm	-	<1.0 ns
NEP (λ_p)	-	4.50×10^{-15} W/Hz ^{1/2}
Saturation Power (CW) ^b	-	5.5 mW (1550 nm)
Damage Threshold	-	18 mW
Bias Voltage	V_R	12 V
Dark Current ^{a,d}	I_D	0.235 nA
Output Voltage	V_{OUT}	0 to 1 V (50 Ω) ^e 0 to 10 V (Hi-Z)
General		
Input	FC/PC Fiber Connector	
Output	SMA (DC Coupled)	
Package Size	2.21" x 1.40" x 0.80" (56.1 mm x 35.6 mm x 20.3 mm)	
Ball Lens Diameter	0.059" (1.50 mm)	
Weight	0.18 kg	
Storage Temp	0 to 40 °C	
Operating Temp	0 to 40 °C	
Battery	A23, 12 V _{DC} , 40 mAh	
Replacement Battery	Energizer No. A23	

The Rise Time specification is theoretical and is derived from formulas found in Section 4.6 above. Measured specifications are tested and guaranteed in our

^a Measured with specified bias voltage of 12V.

^b For a 50 Ω Load

^c Low battery voltage will result in slower rise times and decreased bandwidth.

^d For a 1 M Ω Load

^e Calculated based upon peak responsivity and damage threshold.

production units. Bandwidth is defined as the boundary at which the output of the circuit is 3 dB below the nominal output.

7.1. Response Curve

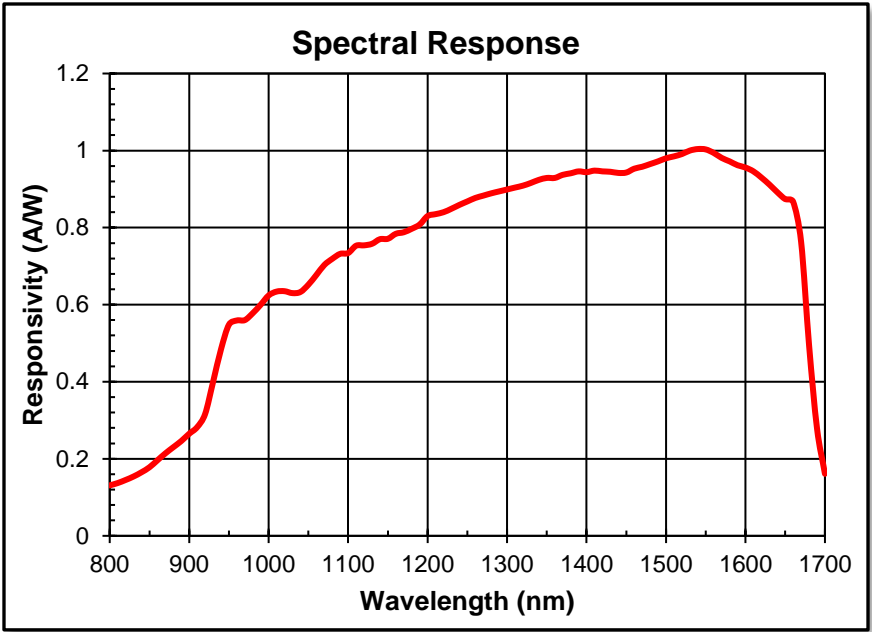

7.2. Mechanical Drawing

Visit the web for a more detailed mechanical drawing.

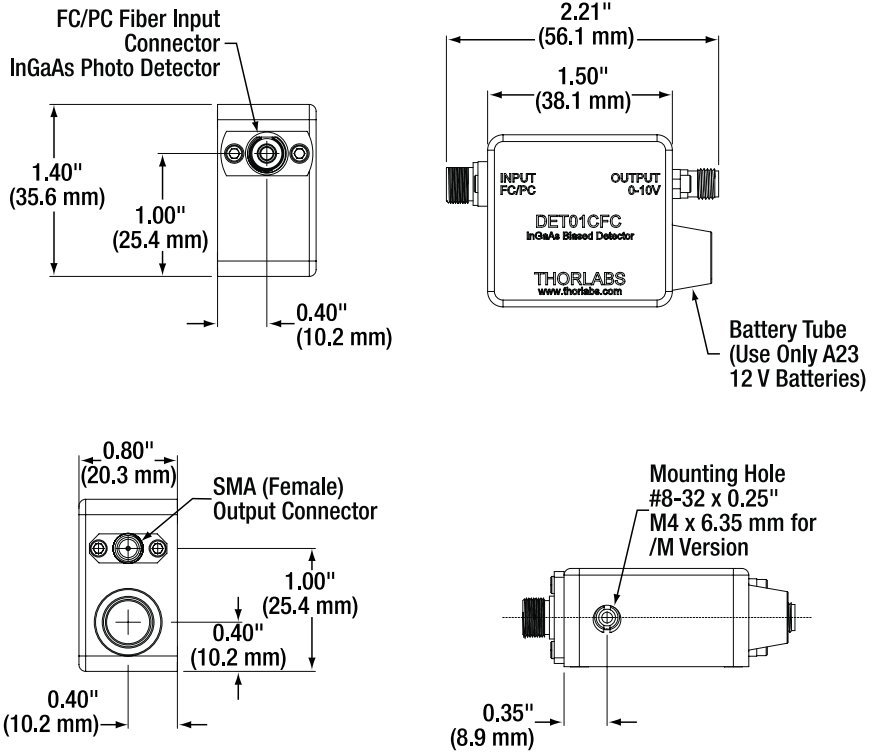

Chapter 8 Certificate of Conformance



THORLABS

www.thorlabs.com

EU Declaration of Conformity

in accordance with EN ISO 17050-1:2010

We: Thorlabs Inc.

Of: 56 Sparta Avenue, Newton, New Jersey, 07860, USA

in accordance with the following Directive(s):

2014/35/EU	Low Voltage Directive (LVD)
2014/30/EU	Electromagnetic Compatibility (EMC) Directive
2011/65/EU	Restriction of Use of Certain Hazardous Substances (RoHS)

hereby declare that:

Model: PDA10A, PDA8A, PDF10A, PDA36A, PDA100A, PDARA3M, PDF10A/M, PDA36A-EC, PDA10AEC, PDA100A-EC, PDA10CF, PDA10CS, PDF10C, PDA10D, PDA10CF-EC, PDA10CS-EC, PDF10CAL, PDA10D-EC, PDA50B, PDA50B-EC, PDA50G, PDA20H, PDA30G-EC, PDA20H-EC, PDA25K, PDA25K-EC, DE125K, DE125K/M, DET10A, DET36A, DET100A, DET100A/M, DET10A/M, DET36A/M, DET50B, DET50B/M, DET20C, DET20C/M, DET50B, DET30B/M, PDA50B, PDA50B-EC, DET10D, DET10D/M, PDA20C, PDA20C/M, PDA20CS, PDA20CS-EC, DET01CF, DET01CF/M, DET02AFC, DET02AFC/M, DET08CF, DET08C, DET08CL, DET08CF/M, DET08CAL, DET08CAL/M, DET025AFC, DET025A, DET025AFC/M, DET025A/M, DET025A/M

Equipment: **Fixed and Switchable Gain Detectors**

is in conformity with the applicable requirements of the following documents:

EN 61010-1	Safety Requirements for Electrical Equipment for Measurement, Control and Laboratory Use.	2010
EN 61326-1	Electrical Equipment for Measurement, Control and Laboratory Use - EMC Requirements	2013

and which, issued under the sole responsibility of Thorlabs, is in conformity with Directive 2011/65/EU of the European Parliament and of the Council of 8th June 2011 on the restriction of the use of certain hazardous substances in electrical and electronic equipment, for the reason stated below:

does not contain substances in excess of the maximum concentration values tolerated by weight in homogenous materials as listed in Annex II of the Directive

I hereby declare that the equipment named has been designed to comply with the relevant sections of the above referenced specifications, and complies with all applicable Essential Requirements of the Directives.

Signed:  On: 13 January 2017

Name: Ann Strachan

Position: Compliance Manager

EDC - PDA and DET family products -2017...

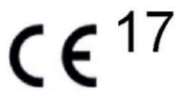

Chapter 9 Regulatory

As required by the WEEE (Waste Electrical and Electronic Equipment Directive) of the European Community and the corresponding national laws, Thorlabs offers all end users in the EC the possibility to return “end of life” units without incurring disposal charges.

- This offer is valid for Thorlabs electrical and electronic equipment:
- Sold after August 13, 2005
- Marked correspondingly with the crossed out “wheelie bin” logo (see right)
- Sold to a company or institute within the EC
- Currently owned by a company or institute within the EC
- Still complete, not disassembled and not contaminated

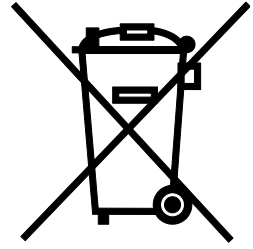

Wheelie Bin Logo

As the WEEE directive applies to self contained operational electrical and electronic products, this end of life take back service does not refer to other Thorlabs products, such as:

- Pure OEM products, that means assemblies to be built into a unit by the user (e.g. OEM laser driver cards)
- Components
- Mechanics and optics
- Left over parts of units disassembled by the user (PCB's, housings etc.).

If you wish to return a Thorlabs unit for waste recovery, please contact Thorlabs or your nearest dealer for further information.

9.1. Waste Treatment is Your Own Responsibility

If you do not return an “end of life” unit to Thorlabs, you must hand it to a company specialized in waste recovery. Do not dispose of the unit in a litter bin or at a public waste disposal site.

9.2. Ecological Background

It is well known that WEEE pollutes the environment by releasing toxic products during decomposition. The aim of the European RoHS directive is to reduce the content of toxic substances in electronic products in the future.

The intent of the WEEE directive is to enforce the recycling of WEEE. A controlled recycling of end of life products will thereby avoid negative impacts on the environment.

Chapter 10 Thorlabs Worldwide Contacts

For technical support or sales inquiries, please visit us at www.thorlabs.com/contact for our most up-to-date contact information.



USA, Canada, and South America

Thorlabs, Inc.
sales@thorlabs.com
techsupport@thorlabs.com

Europe

Thorlabs GmbH
europe@thorlabs.com

France

Thorlabs SAS
sales.fr@thorlabs.com

Japan

Thorlabs Japan, Inc.
sales@thorlabs.jp

UK and Ireland

Thorlabs Ltd.
sales.uk@thorlabs.com
techsupport.uk@thorlabs.com

Scandinavia

Thorlabs Sweden AB
scandinavia@thorlabs.com

Brazil

Thorlabs Vendas de Fotônicos Ltda.
brasil@thorlabs.com

China

Thorlabs China
chinasales@thorlabs.com



THORLABS

www.thorlabs.com
