

HLV3-22RD-1

Unit: mm

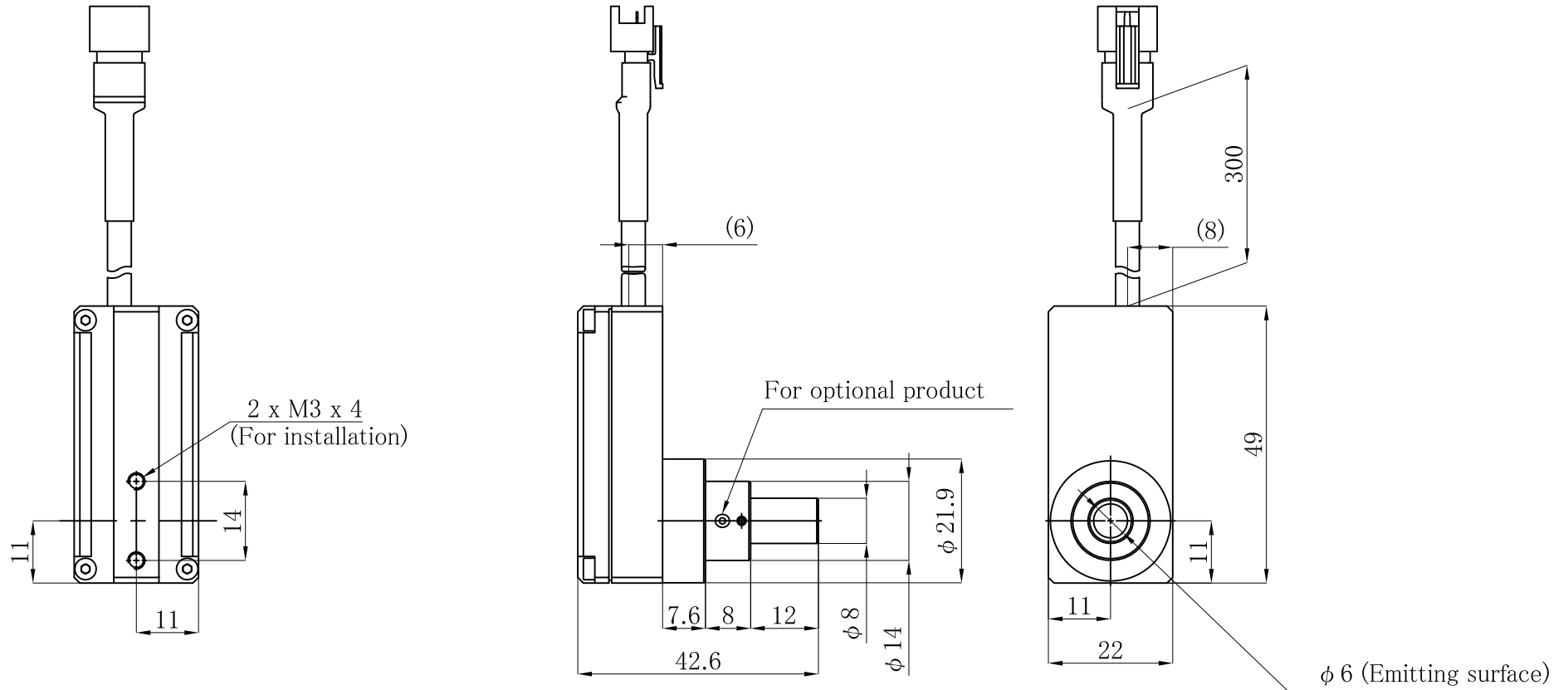

Model	Input Current	Power Consumption
HLV3-22SW-1	0.385 A max.	1.4 W max.
HLV3-22RD-1	0.385 A max.	1.1 W max.
HLV3-22BL-1	0.385 A max.	1.5 W max.
HLV3-22GR-1	0.385 A max.	1.5 W max.