

	PART DESCRIPTION	MATERIAL
①	SM2RR	ANODIZED ALUMINUM
②	LA1384	N-BK7
③	ENGRAVED HOUSING	ANODIZED ALUMINUM

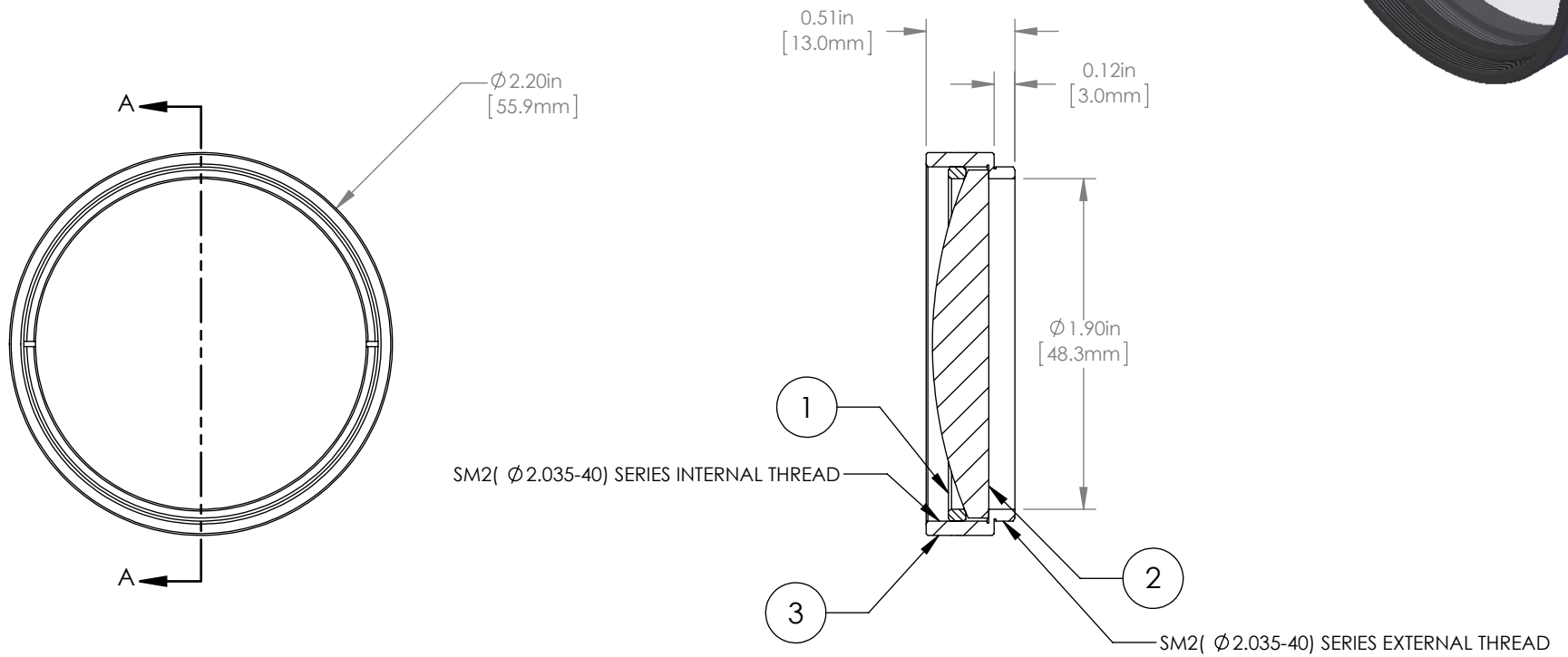

NOTES/SPECIFICATIONS:

1. DESIGN WAVELENGTH: 633nm
2. FOCAL LENGTH: $f=125.0\text{mm} \pm 1\%$
3. WORKING DISTANCE (REF): 115.8mm
4. CLEAR APERTURE: $> \text{Ø} 45.72\text{mm}$
5. SURFACE QUALITY: 40-20 SCRATCH-DIG

FOR INFORMATION ONLY
NOT FOR MANUFACTURING PURPOSES

DRAWING PROJECTION			THORLABS www.thorlabs.com Ø 2" MOUNTED PLANO-CONVEX LENS, f=125mm	
NAME	DATE			
DRAWN	GG	15/OCT/15	MATERIAL SEE TABLE	
APPROVAL	DD	15/OCT/15		
COPYRIGHT © 2015 BY THORLABS				
VALUES IN PARENTHESIS ARE CALCULATED AND MAY CONTAIN ROUND OFF ERRORS			ITEM #	APPROX WEIGHT
			LA1384-ML	42 g