

NOTES:

**FOR INFORMATION ONLY:  
DO NOT MANUFACTURE  
PARTS TO THIS DRAWING**

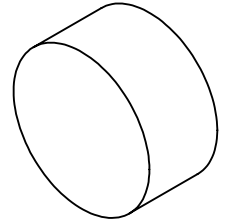

1. SUBSTRATE:FUSED SILICA
2. SURFACE S2 TO BE PARALLEL WITH SURFACE S1 TO WITHIN <3 <3 ARCMIN
3. COATING (APPLY ACROSS COATING APERTURE):  
 S1: R(ABS) > 99% @ 1064nm  
 T(ABS) > 95% @ 355nm @ 45° AOI  
  
 DAMAGE THRESHOLD (PULSED):  
 7.5 J/cm² @ 20ns , 20 Hz @ 1064nm  
 2.5 J/cm² @ 20ns , 20 Hz @ 355nm  
  
 S2: R(ABS) < 0.25% @ 355nm @ 45° AOI  
  
 DAMAGE THRESHOLD (PULSED):  
 7.5 J/cm² @ 20ns , 20 Hz @ 355nm

FINE GRIND SURFACE

5. ROHS COMPLIANT

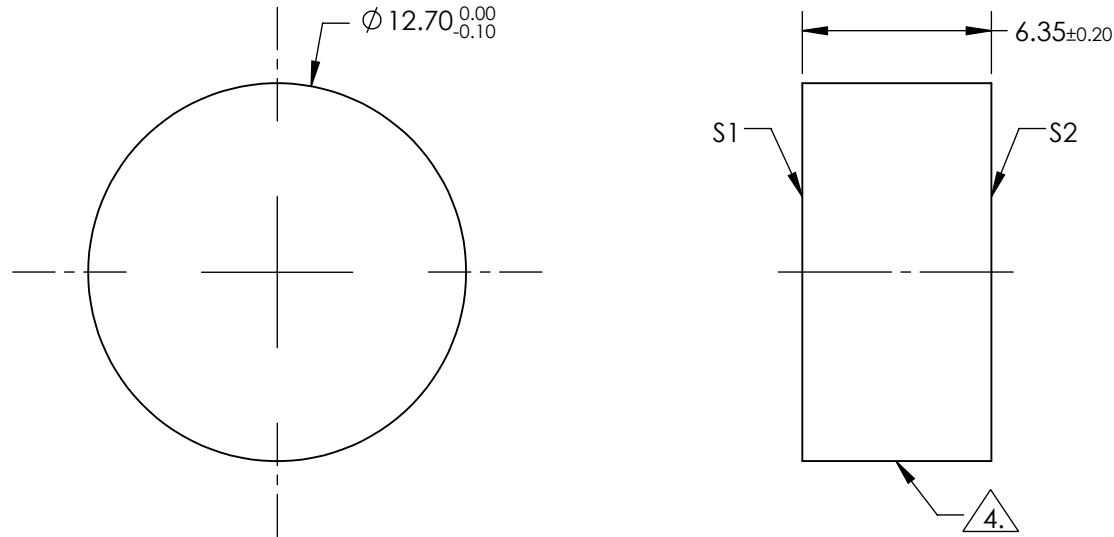

SPECIFICATIONS SUBJECT TO CHANGE WITHOUT NOTICE  
DIMENSIONS ARE FOR REFERENCE ONLY

**Edmund Optics®**

	S1	S2
SHAPE	PLANO	PLANO
SURFACE QUALITY	10-5	10-5
CLEAR APERTURE	Ø10.80	Ø10.80
BEVEL	PROTECTIVE AS NEEDED	PROTECTIVE AS NEEDED

THIRD ANGLE  
PROJECTION

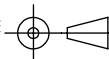

ALL DIMS IN

mm

TITLE

Ø12.7mm HS 532, 1064R/355T HARMONIC  
BEAMSPLITTER

DWG NO

37722

SHEET  
1 OF 1