

56 Sparta Avenue • Newton, New Jersey 07860
 (973) 300-3000 Sales • (973) 300-3600 Fax
 www.thorlabs.com

THORLABS

PDA20H-EC - JUL 2, 2020

Item # PDA20H-EC was discontinued on JUL 2, 2020. For informational purposes, this is a copy of the website content at that time and is valid only for the stated product.

PBSE TRANSIMPEDANCE AMPLIFIED PHOTODETECTOR

- ▶ PbSe Amplified Photoconductive Detector
- ▶ Linear Response for 1.5 - 4.8 μm
- ▶ Fixed Amplified Detector with Output up to 10 V



OVERVIEW

Features

- Detect Light from 1.5 - 4.8 μm
- Higher Sensitivity and Better Linear Response in the Mid-IR (MIR) than Typical PIN Junction Photodiodes
- Two 8-32 (M4) Tapped Mounting Holes for Post Mounting
- Internally SM1 (1.035"-40) Threaded

Thorlabs' PDA20H(-EC) Amplified Detector, based on a photoconductive lead selenide (PbSe) detector element, is sensitive to mid-IR radiation (MIR) in the 1.5 - 4.8 μm spectral range. It detects light in a broader wavelength range, offers higher sensitivity, and provides better linear response in the MIR than typical PIN junction photodiodes.

The slim profile housing enables use in light paths with space constraints. All connections and controls are located perpendicular to the light path, providing increased accessibility. Amplification is provided by low noise transimpedance or voltage amplifiers that are capable of driving 50 Ω loads.

Signal output is via a BNC connector. This photodetector is ideal for use with

Thorlabs' passive low-pass filters; these filters have a 50 Ω input and a high-impedance output that allows them to be directly attached to high-impedance measurement devices such as an oscilloscope. Thorlabs offers a wide variety of BNC, BNC-to-SMA, and SMC cables, as well as a variety of BNC, SMA, and SMC adapters.



Click to Enlarge

The power supply is included with all of the detectors on this page.

The housing provides two 8-32 tapped mounting holes (M4 for the -EC model) for vertical or horizontal post mounting. The housing also features external SM1 (1.035"-40) threading and internal SM05 (0.535"-40) threading that are compatible with most Thorlabs SM1- and SM05-threaded accessories. Additionally, an internally threaded SM1 coupler is included with each detector. This allows convenient mounting of SM1 compatible accessories, optics, and cage assembly accessories. The internal SM05 threading is only suitable for mating to an externally threaded SM05 lens tube (components such as fiber adapters cannot be threaded onto the SM05 threading). Most SM1-threaded fiber adapters are compatible with this detector. However, the S120-FC internally SM1-threaded fiber adapter is not compatible with this detector. Externally SM1-threaded adapters should be mated to the included internally SM1-threaded adapter, while internally SM1-threaded adapters can be mated directly to the housing.

A ± 12 V linear power supply that supports input voltages of 100, 120, and 230 VAC is included with each amplified photodetector. Replacement power supplies are available separately below. Due to limitations in the IC, the high-speed amplifier used in this device may become unstable, exhibiting oscillations or negative output if the linear power supply voltage is applied when the module is on. The unit should always be powered up using the power switch on the power supply or the unit itself. Hot plugging the unit is not recommended. Additionally, inhomogeneities at the edges of the active area of the detector can generate unwanted capacitance and resistance effects that distort the time-domain response of the photodetector output. Thorlabs therefore recommends that the incident light on the photodetector is well centered on the active area. The SM1 (1.035"-40) threading on the housing is ideally suited for mounting a $\varnothing 1$ " focusing lens or pinhole in front of the detector element.

Photoconductors vs. Photodiodes

Unlike PIN junction photodiodes, which generate a photocurrent when light is absorbed in the depleted region of the junction semiconductor, the photoconductive material in these devices exhibits a decrease in electrical resistance when illuminated with IR radiation. Photoconductive detectors typically have a very linear response when illuminated with IR radiation.

Usage Notes

Photoconductors function differently than typical PIN junction photodiodes. We recommend that an optical chopper be employed when using this detector with CW light, due to signal noise issues. PbS and PbSe detectors can be used at room temperature. However, temperature fluctuations will affect dark resistance, sensitivity, and response speeds.

If greater detector bandwidth is desired, Thorlabs manufactures HgCdTe and InAsSb detectors for the mid-IR that offer 160 kHz and 1600 kHz bandwidth, respectively.

MIR Photodetector Selection Guide^a

Item # (Detector)	Wavelength Range	Maximum Bandwidth	Thermoelectric Cooler
PDA10DT (InGaAs)	0.9 - 2.57 μm	1,000 kHz	Yes
PDA10D2 (InGaAs)	0.9 - 2.6 μm	25,000 kHz	No
PDA10PT (InAsSb)	1.0 - 5.8 μm	1,600 kHz	Yes
PDA07P2 (InAsSb)	2.7 - 5.3 μm	9 MHz	No
PDA20H (PbSe)	1.5 - 4.8 μm	10 kHz	No
PDA10JT (HgCdTe)	2.0 - 5.4 μm	160 kHz	Yes
PDAVJ8 (HgCdTe)	2.0 - 8.0 μm	100 MHz	No
PDAVJ10 (HgCdTe)	2.0 - 10.6 μm	100 MHz	No
PDAVJ5 (HgCdTe)	2.7 - 5.0 μm	1 MHz	No

^aSee the *Cross Reference* tab for our full selection of photodetectors.



Click to Enlarge
Each detector has an internal SM05 and external SM1 thread and comes with an attached SM1T1 Internal SM1 Adapter and SM1RR Retaining Ring.

S P E C S

Performance Specifications

Item # ^a	Detector Element	Active Area	Wavelength Range	Peak Responsivity	Bandwidth	Noise-Equivalent Power (NEP) ^b	Rise Time
PDA20H	PbSe	4 mm ² (2 x 2 mm)	1.5 - 4.8 μm	1.5 x 10 ³ V/W (Min) 3.0 x 10 ³ V/W (Typ.) (4.0 μm, 50 Ω Load)	0.2 Hz - 10 kHz	1.5 x 10 ⁻¹⁰ W/Hz ^{1/2}	35 μs

^aThese detectors have AC coupled amplifiers.

^bNEP measurement parameters: 300 K blackbody source, 600 Hz chopping frequency, 635 Hz bandpass filter with 70 Hz noise bandwidth and 22 °C ambient temperature.

Gain Specifications

Item #	Gain Type	Gain with Hi-Z Load	Gain with 50 Ω Load	Output Voltage with Hi-Z Load	Output Voltage with 50 Ω Load
PDA20H	Fixed	100X	50X	±10 V	±5 V

Note: Gain figures can also be expressed in units of Ω.

C O M P A C T D E S I G N

Compact PDA & PDF Series Design

Thorlabs' Amplified Photodiode series features a slim design, which allows the detector access to the light path even between closely spaced optical elements.

The power supply input and the BNC output are located on the same outer edge of the package, further reducing the device thickness and allowing easier integration into tight optic arrangements. The PDA and PDF series detectors can fit into spaces as thin as 0.83" (21.1 mm) when the SM1 coupler is removed. With the SM1 coupler attached, the smallest width the detector can fit into is 1.03" (26.2 mm).

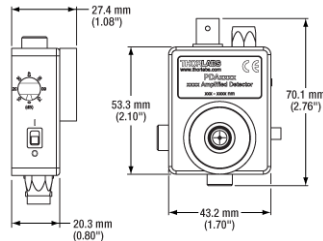

PDA Series Design, scale in inches [mm].

Additionally, the detectors have two tapped mounting holes perpendicular to each other so that the unit can be mounted in a horizontal or vertical orientation. This dual mounting feature offsets the fact that the cables protrude out the side of the package, thus requiring more free space above or alongside your beam path.

The switchable gain detectors feature an eight-position rotary gain switch (pictured below right) mounted on an outside edge perpendicular to the power supply and BNC output connections. The location of the gain switch allows for easy adjustments while the detector is mounted.



PIN DIAGRAMS

**BNC Female Output
(Photodetector)**

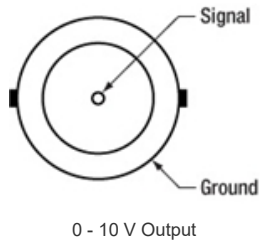

PDA Male (Power Cables)

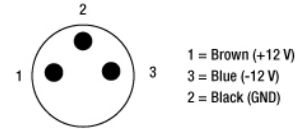

PDA Female (Photodetector)

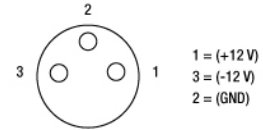

MOUNTING OPTIONS

PDA Series Mounting Options

The PDA series of amplified photodetectors are compatible with our entire line of lens tubes, TR series posts, and cage mounting systems. Because of the wide range of mounting options, the best method for mounting the housing in a given optical setup is not always obvious. The pictures and text in this tab will discuss some of the common mounting solutions. As always, our technical support staff is available for individual consultation.

		
<p>Picture of a PDA series photodetector as it will look when unpackaged.</p>	<p>Picture of a PDA series photodetector with the included SM1T1 and its retaining ring removed from the front of the housing. Thorlabs' DET series photodetectors feature the same mounting options.</p>	<p>A close up picture of the front of the PDA10A2 photodetector. The internal SM1 threading on the SM1T1 adapter and internal SM05 threading on the photodetector housing can be seen in this image.</p>

TR Series Post ($\varnothing 1/2$ " Posts) System

The PDA housing can be mounted vertically or horizontally on a TR Series Post using the threaded holes for 8-32 (M4 on metric versions). Select PDA housings feature universally threaded holes for both 8-32 and M4 threads.

	
<p>PDA series photodetector mounted vertically on a TR series post. In this configuration, the output and power cables (PDA series) are oriented vertically and away from the optic table, facilitating a neater optical setup.</p>	<p>PDA series photodetector mounted horizontally on a TR series post. In this configuration, the on/off switch is conveniently oriented on the top of the detector.</p>

Lens Tube System

Each PDA housing includes a detachable $\varnothing 1$ " Optic Mount (SM1T1) that allows for $\varnothing 1$ " ($\varnothing 25.4$ mm) optical components, such as optical filters and lenses, to be mounted along the axis perpendicular to the center of the photosensitive region. The maximum thickness of an optic that can be mounted in the SM1T1 is 0.1" (2.8 mm). For thicker $\varnothing 1$ " ($\varnothing 25.4$ mm) optics or for any thickness of $\varnothing 0.5$ " ($\varnothing 12.7$ mm) optics, remove the SM1T1 from the front of the detector and place (must be purchased separately) an SM1 or SM05 series lens tube, respectively, on the front of the detector.

The SM1 and SM05 threadings on the PDA photodetector housing make it compatible with our SM lens tube system and accessories. Two particularly useful accessories include the SM-threaded irises and the SM-compatible IR and visible alignment tools. Also available are fiber optic adapters for use with connectorized fibers.



PDA series photodetector mounted onto a Ø1" Slotted Lens Tube, which is housing a focusing optic. The lens tube is attached to a 30 mm cage system via a CP33 SM1-Threaded 30 mm Cage Plate. This arrangement allows easy access for optic adjustment and signal alignment.

Cage System

The simplest method for attaching the PDA photodetector housing to a cage plate is to remove the SM1T1 that is attached to the front of the PDA and use the external SM1 threads. A cage plate, such as the CP33 30 mm cage plate, can be directly attached to the SM1 threads. Then the retaining ring, included with the SM1T1, can be threaded using a spanner wrench into the CP33 to ensure the cage plate is tightened to the desired location and square with the photodetector housing.

This method for attaching the PDA photodetector housing to a cage plate does not allow much freedom in determining the orientation of the photodetector; however, it has the benefit of not needing an adapter piece, and it allows the diode to be as close as possible to the cage plate, which can be important in setups where the light is divergent. As a side note, Thorlabs sells the SM05PD and SM1PD series of photodiodes that can be threaded into a cage plate so that the diode is flush with the front surface of the cage plate; however, the photodiode is unbiased.

For more freedom in choosing the orientation of the PDA photodetector housing when attaching it, an SM1T2 lens tube coupler can be purchased. In this configuration the SM1T1 is left on the detector and the SM1T2 is threaded into it. The exposed external SM1 threading is now deep enough to secure the detector to a CP33 cage plate in any orientation and lock it into place using one of the two locking rings on the ST1T2.



This picture shows a PDA series photodetector attached to a CP33 cage plate after removing the SM1T1. The retaining ring from the SM1T1 was used to make the orientation of the detector square with the cage plate.

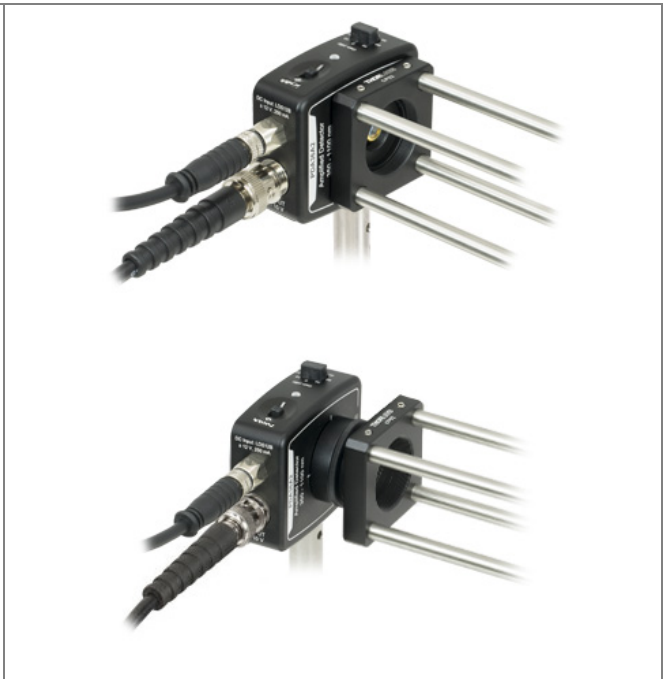

These two pictures show a PDA series photodetector in a horizontal configuration. The top picture shows the detector directly coupled to a CP33 cage plate. The bottom picture shows a PDA series photodetector attached to a CP33 cage plate using an SM1T2 lens tube coupler.

plate using an SM1T2 adapter in addition to the SM1T1 that comes with the PDA series detector.

Although not pictured here, the PDA photodetector housing can be connected to a 16 mm cage system by purchasing an SM05T2. It can be used to connect the PDA photodetector housing to an SP02 cage plate.

Application

The image below shows a Michelson Interferometer built entirely from parts available from Thorlabs. This application demonstrates the ease with which an optical system can be constructed using our lens tube, TR series post, and cage systems.



The table below contains a part list for the Michelson Interferometer for use in the visible range. Follow the links to the pages for more information about the individual parts.

Item #	Quantity	Description	Item #	Quantity	Description
KC1	1	Mirror Mount	CT1	1	1/2" Travel Translator
BB1-E02	2	Broadband Dielectric Laser Mirrors	SM1D12	1	SM1 Threaded Lens Tube Iris
ER4	8	4" Cage Rods	SM1L30C	1	SM1 3" Slotted Lens Tube
ER6	4	6" Cage Rods	SM1V05	1	Ø1" Adjustable Length Lens Tube
CCM1-BS013	1	Cube-Mounted Beamsplitter	CP08FP	1	30 mm Cage Plate for FiberPorts
BA2	1	Post Base (not shown in picture)	PAF2-5A	1	FiberPort
TR2	1	Ø1/2" Post, 2" in Length	P1-460B-FC-2	1	Single Mode Fiber Patch Cable
PH2	1	Ø1/2" Post Holder	DET36A / PDA36A2	1	Biased / Amplified Photodiode Detector

PbS and PbSe Photoconductive Detectors

Lead Sulfide (PbS) and Lead Selenide (PbSe) photoconductive detectors are widely used in detection of infrared radiation from 1000 to 4800 nm. Unlike standard photodiodes, which produce a current when exposed to light, the electrical resistance of the photoconductive material is reduced when illuminated with light. Although PbS and PbSe detectors can be used at room temperature, temperature fluctuations will affect dark resistance, sensitivity, and response speeds (see Temperature Considerations below).

Theory of Operation

For photoconductive materials, incident light will cause the number of charge carriers in the active area to increase, thus decreasing the resistance of the detector. This change in resistance leads to a change in measured voltage, and hence, photosensitivity is expressed in units of V/W. An example operating circuit is shown to the right. Please note that the circuit depicted is not recommended for practical purposes since low frequency noise will be present.

The detection mechanism is based upon the conductivity of the thin film of the active area. The output signal of the detector with no incident light is defined by the following equation:

$$V_{OUT} = \frac{R_{LOAD}}{R_{DARK} + R_{LOAD}} * V_{BIAS}$$

A change ΔV_{OUT} then occurs due to a change ΔR_{DARK} in the resistance of the detector when light strikes the active area:

$$\Delta V_{OUT} = - \frac{R_{LOAD} V_{BIAS}}{(R_{DARK} + R_{LOAD})^2} * \Delta R_{DARK}$$

Frequency Response

Photoconductors must be used with a pulsed signal to obtain AC signals. Hence, an optical chopper should be employed when using these detectors with CW light. The detector responsivity (R_f) when using a chopper can be calculated using the equation below:

$$R_f = \frac{R_0}{\sqrt{1 + 4\pi^2 f_c^2 \tau_r^2}}$$

Here, f_c is the chopping frequency, R_0 is the response at 0 Hz, and τ_r is the detector rise time.

Effects of Chopping Frequency

The photoconductor signal will remain constant up to the time constant response limit. PbS and PbSe detectors have a typical 1/f noise spectrum (i.e., the noise decreases as chopping frequency increases), which has a profound impact on the time constant at lower frequencies.

The detector will exhibit lower responsivity at lower chopping frequencies. Frequency response and detectivity are maximized for

$$f_c = \frac{1}{2\pi\tau_r}$$

See Chapter 5 of the manuals for detector rise time values.

Temperature Considerations

These detectors consist of a thin film on a glass substrate. The effective shape and active area of the photoconductive surface varies considerably based upon the operating conditions, thus changing performance characteristics. Specifically, responsivity of the detector will change based upon the operating temperature.

Temperature characteristics of PbS and PbSe bandgaps have a negative coefficient, so cooling the detector shifts its spectral response range to longer wavelengths. For best results, operate the photodiode in a stable controlled environment.

Typical Photoconductor Amplifier Circuit

Due to the noise characteristic of a photoconductor, it is generally suited for AC coupled operation. The DC noise present with the applied bias will be too great at high bias levels, thus limiting the practicality of the detector. For this reason, IR detectors are normally AC coupled to limit the noise. A pre-amplifier is required to help maintain the stability and provide a large gain for the generated current signal.

Based on the schematic below, the op-amp will try to maintain point A to the input at B via the use of feedback. The difference between the two input voltages is amplified and provided at the output. It is also important to note the high pass filter that AC couples the input of the amplifier blocks any DC signal. In addition,

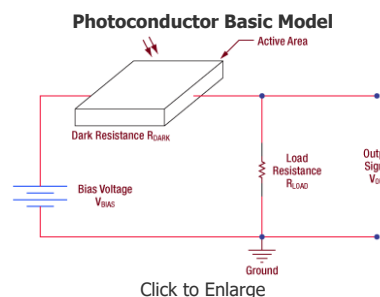

Click to Enlarge

the resistance of the load resistor (R_{LOAD}) should be equal to the dark resistance of the detector to ensure maximum signal can be acquired. The supply voltage (+V) should be at a level where the SNR is acceptable and near unity. Some applications require higher voltage levels; as a result the noise will increase. The output voltage is derived as the following:

$$V_{out} = \left(1 + \frac{R_f}{R_i}\right) * I_s R_D$$

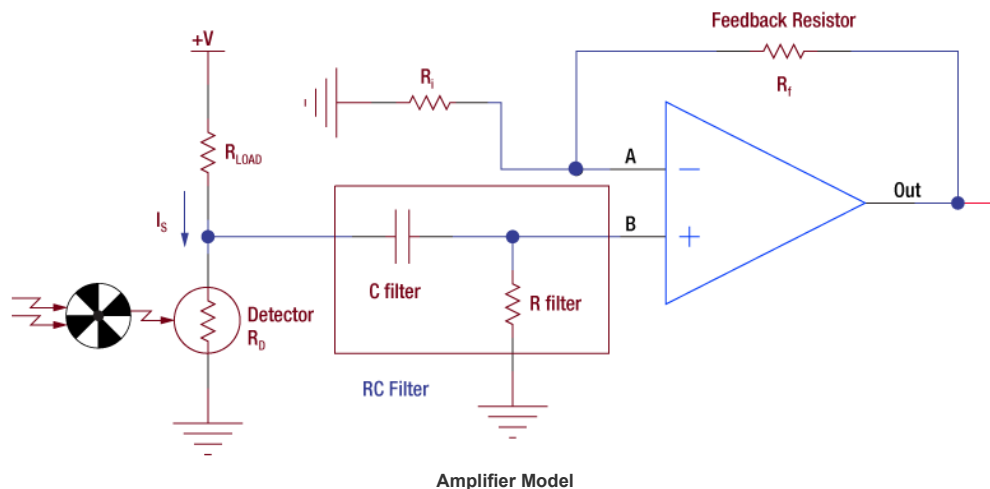

Signal to Noise Ratio

Since the detector noise is inversely proportional to the chopping frequency, the noise will be greater at low frequencies. The detector output signal is linear to increased bias voltage, but the noise shows little dependence on the bias at low levels. When a set bias voltage is reached, the detector noise will increase linearly with applied voltage. At high voltage levels, noise tends to increase exponentially, thus degrading the signal to noise ratio (SNR) further. To yield the best SNR, adjust the chopping frequency and bias voltage to an acceptable level.

Noise Equivalent Power

The noise equivalent power (NEP) is the generated RMS signal voltage generated when the signal to noise ratio is equal to one. This is useful, as the NEP determines the ability of the detector to detect low level light. In general, the NEP increases with the active area of the detector and is given by the following equation:

$$NEP = \frac{\text{Incident Energy} * \text{Area}}{\frac{S}{N} * \sqrt{\Delta f}}$$

Here, S/N is the Signal to Noise Ratio, Δf is the Noise Bandwidth, and Incident Energy has units of W/cm^2 . For more information on NEP, please see Thorlabs' Noise Equivalent Power White Paper.

Dark Resistance

Dark Resistance is the resistance of the detector under no illumination. It is important to note that dark resistance will increase or decrease with temperature. Cooling the device will increase the dark resistance.

Detectivity (D) and Specific Detectivity (D*)

Detectivity (D) is another criteria used to evaluate the performance of the photodetector. Detectivity is a measure of sensitivity and is the reciprocal of NEP.

$$D = \frac{1}{NEP}$$

Higher values of detectivity indicate higher sensitivity, making the detector more suitable for detecting low light signals. Detectivity varies with the wavelength of the incident photon.

NEP of a detector depends upon the active area of the detector, which in essence will also affect detectivity. This makes it hard to compare the intrinsic properties of two detectors. To remove the dependence, Specific Detectivity (D^*), which is not dependent on detector area, is used to evaluate the performance of the photodetector.

$$D^* = \frac{\sqrt{\text{Area}}}{NEP}$$

CROSS REFERENCE

The following table lists Thorlabs' selection of photodiodes and photoconductive detectors. Item numbers in the same row contain the same detector element.



Photodetector Cross Reference						
Wavelength	Material	Unmounted Photodiode	Unmounted Photoconductor	Mounted Photodiode	Biased Detector	Amplified Detector
150 - 550 nm	GaP	FGAP71	-	SM05PD7A	DET25K2	PDA25K2
200 - 1100 nm	Si	FDS010	-	SM05PD2A SM05PD2B	DET10A2	PDA10A2
	Si	-	-	SM1PD2A	-	-
320 - 1000 nm	Si	-	-	-	-	PDA8A2
320 - 1100 nm	Si	FD11A	-	SM05PD3A	-	PDF10A2
	Si	-	-	-	DET100A2	PDA100A2
340 - 1100 nm	Si	FDS10X10	-	-	-	-
350 - 1100 nm	Si	FDS100 FDS100-CAL ^a	-	SM05PD1A SM05PD1B	DET36A2	PDA36A2
	Si	FDS1010 FDS1010-CAL ^a	-	SM1PD1A SM1PD1B	-	-
400 - 1000 nm	Si	-	-	-	-	PDA015A(/M) FPD310-FS-VIS FPD310-FC-VIS FPD510-FC-VIS FPD510-FS-VIS FPD610-FC-VIS FPD610-FS-VIS
400 - 1100 nm	Si	FDS015 ^b	-	-	-	-
	Si	FDS025 ^b FDS02 ^c	-	-	DET02AFC(/M) DET025AFC(/M) DET025A(/M) DET025AL(/M)	-
400 - 1700 nm	Si & InGaAs	DSD2	-	-	-	-
500 - 1700 nm	InGaAs	-	-	-	DET10N2	-
750 - 1650 nm	InGaAs	-	-	-	-	PDA8GS
800 - 1700 nm	InGaAs	FGA015	-	-	-	PDA015C(/M)
	InGaAs	FGA21 FGA21-CAL ^a	-	SM05PD5A	DET20C2	PDA20C2 PDA20CS2
	InGaAs	FGA01 ^b FGA01FC ^c	-	-	DET01CFC(/M)	-
	InGaAs	FDGA05 ^b	-	-	-	PDA05CF2
	InGaAs	-	-	-	DET08CFC(/M) DET08C(/M) DET08CL(/M)	PDF10C(/M)
800 - 1800 nm	Ge	FDG03 FDG03-CAL ^a	-	SM05PD6A	DET30B2	PDA30B2
	Ge	FDG50	-	-	DET50B2	PDA50B2
	Ge	FDG05	-	-	-	-
900 - 1700 nm	InGaAs	FGA10	-	SM05PD4A	DET10C2	PDA10CS2
900 - 2600 nm	InGaAs	FD05D	-	-	DET05D2	-
		FD10D	-	-	DET10D2	PDA10D2
950 - 1650 nm	InGaAs	-	-	-	-	FPD310-FC-NIR FPD310-FS-NIR FPD510-FC-NIR FPD510-FS-NIR FPD610-FC-NIR FPD610-FS-NIR
1.0 - 5.8 μ m	InAsSb	-	-	-	-	PDA10PT(-EC)
1.5 - 4.8 μ m	PbSe	-	FDPSE2X2	-	-	PDA20H(-EC)
2.0 - 5.4 μ m	HgCdTe (MCT)	-	-	-	-	PDA10JT(-EC)

Photodetector Cross Reference

Wavelength	Material	Unmounted Photodiode	Unmounted Photoconductor	Mounted Photodiode	Biased Detector	Amplified Detector
2.0 - 8.0 μm	HgCdTe (MCT)	VML8T0 VML8T4 ^d	-	-	-	PDAVJ8
2.0 - 10.6 μm	HgCdTe (MCT)	VML10T0 VML10T4 ^d	-	-	-	PDAVJ10
2.7 - 5.0 μm	HgCdTe (MCT)	VL5T0	-	-	-	PDAVJ5
2.7 - 5.3 μm	InAsSb	-	-	-	-	PDA07P2

- a. Calibrated Unmounted Photodiode
 b. Unmounted TO-46 Can Photodiode
 c. Unmounted TO-46 Can Photodiode with FC/PC Bulkhead
 d. Photovoltaic Detector with Thermoelectric Cooler

Amplified PbSe Photodetector: 1.5 - 4.8 μm

Item #	PDA20H ^a
Click Image to Enlarge ^b	
Detector Element (Click for Image)	PbSe
Wavelength Range	1.5 - 4.8 μm
Peak Wavelength (λ_p)	4.0 μm
Peak Responsivity	1.5 x 10 ³ V/W (Min) at λ_p 3.0 x 10 ³ V/W (Typ.) at λ_p
Photosensitivity Curve (Click to View)	
Active Area	4 mm ² (2 mm x 2 mm)
Gain	100X for Hi-Z Loads 50X for 50 Ω Loads
Bandwidth Range	0.2 Hz - 10 kHz
Noise-Equivalent Power (NEP) ^c	1.5x10 ⁻¹⁰ W/Hz ^{1/2}

- All values in the table are for a 50 Ω load, unless otherwise specified.
- All photodetectors are shown with the included SM1T1 Internal SM1 Adapter attached.
- NEP measurement parameters: 300 K blackbody source, 600 Hz chopping frequency, 635 Hz bandpass filter with 70 Hz noise bandwidth and 22 °C ambient temperature.

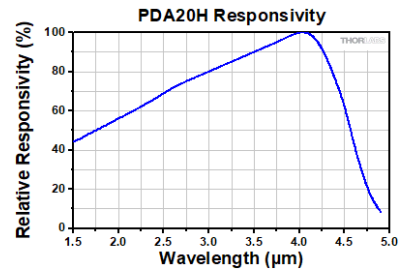

Click to Enlarge
 Click Here for Raw Data
 The graph above is for a 50 Ohm load.

These items will be retired without replacement when stock is depleted. If you require these parts for line production, please contact our OEM Team.

**Limited
STOCK**

Part Number	Description	Price	Availability
PDA20H-EC	PbSe Fixed Gain Detector, 1.5-4.8 μm , AC-Coupled Amplifier, 10 kHz BW, 4 mm ² , M4 Taps	\$483.71	Lead Time
PDA20H	PbSe Fixed Gain Detector, 1.5-4.8 μm , AC-Coupled Amplifier, 10 kHz BW, 4 mm ² , 8-32 Taps	\$483.71	Lead Time

PDA Power Supply Cable

The PDA-C-72 power cord is offered for the PDA line of amplified photodetectors when using with a power supply other than the one included with the detector. The cord has tinned leads on one end and a PDA-compatible 3-pin connector on the other end. It can be used to power the PDA series of amplified photodetectors with any power supply that provides a DC voltage. The pin descriptions are shown to the right.

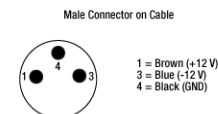

Part Number	Description	Price	Availability
PDA-C-72	72" PDA Power Supply Cable, 3-Pin Connector	\$21.10	Today

±12 VDC Regulated Linear Power Supply

- ▶ Replacement Power Supply for the PDA and PDF Amplified Photodetectors Sold Above
- ▶ ±12 VDC Power Output
- ▶ Current Limit Enabling Short Circuit and Overload Protection
- ▶ On/Off Switch with LED Indicator
- ▶ Switchable AC Input Voltage (100, 120, or 230 VAC)
- ▶ 2 m (6.6 ft) Cable with LUMBERG RSMV3 Male Connector
- ▶ UL and CE Compliant

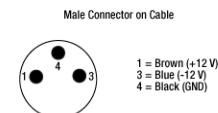

The LDS12B ±12 VDC Regulated Linear Power Supply is intended as a replacement for the supply that comes with our PDA and PDF line of amplified photodetectors sold on this page. The cord has three pins: one for ground, one for +12 V, and one for -12 V (see diagram above). A region-specific power cord is shipped with the LDS12B power supply based on your location. This power supply can also be used with the PDB series of balanced photodetectors, PMM series of photomultiplier modules, APD series of avalanche photodetectors, and the FSAC autocorrelator for femtosecond lasers.

Part Number	Description	Price	Availability
LDS12B	±12 VDC Regulated Linear Power Supply, 6 W, 100/120/230 VAC	\$85.22	Today

Internally SM1-Threaded Fiber Adapters

These internally SM1-threaded (1.035"-40) adapters mate terminated fiber to any of our externally SM1-threaded components, including our photodiode power sensors, our thermal power sensors, and our photodetectors. These adapters are compatible with the housing of the photodetectors on this page.

The APC adapter has two dimples in the front surface that allow it to be tightened with the SPW909 or SPW801 spanner wrench. The dimples do not go all the way through the disk so that the adapter can be used in light-tight applications when paired with SM1 lens tubes.

Item #	S120-APC ^a	S120-SMA	S120-ST	S120-SC	S120-LC
Adapter Image (Click the Image to Enlarge)					
Fiber Connector Type	FC/APC ^b	SMA	ST/PC	SC/PC ^c	LC/PC
Thread	Internal SM1 (1.035"-40)				

- The S120-APC is designed with a 4° mechanical angle to compensate for the refraction angle of the output beam.
- This connector uses a wide key (2.2 mm).
- In certain angle-independent applications, this adapter may also be used with SC/APC connectors.

Part Number	Description	Price	Availability
S120-APC	Customer Inspired! FC/APC Fiber Adapter Cap with Internal SM1 (1.035"-40) Threads, Wide Key (2.2 mm)	\$32.96	5-8 Days
S120-SMA	SMA Fiber Adapter Cap with Internal SM1 (1.035"-40) Threads	\$42.20	Today
S120-ST	ST/PC Fiber Adapter Cap with Internal SM1 (1.035"-40) Threads	\$42.20	Today
S120-SC	SC/PC Fiber Adapter Cap with Internal SM1 (1.035"-40) Threads	\$53.02	Today
S120-LC	LC/PC Fiber Adapter Cap with Internal SM1 (1.035"-40) Threads	\$53.02	Today

Externally SM1-Threaded Fiber Adapters

- ▶ FC/PC (Wide Key), FC/APC (Narrow or Wide Key), SMA, ST/PC, SC/PC, or LC/PC Receptacles
- ▶ Light-Tight When Used with SM1 Lens Tubes
- ▶ Compatible with Many of Our 30 mm Cage Plates and Photodetectors

Each disk has four dimples, two in the front surface and two in the back surface, that allow it to be tightened from either side with the SPW909 or SPW801 spanner wrench. The dimples do not go all the way through the disk so that the adapters can be used in light-tight applications when paired with SM1 lens tubes. Once the adapter is at the desired position, use an SM1RR retaining ring to secure it in place.

Item #	SM1FC	SM1FCA2 ^a	SM1FCA ^a	SM1SMA	SM1ST	SM1SC1 ^b	SM1LC ^b
Adapter Image (Click the Image to Enlarge)							
Connector Type	FC/PC, 2.2 mm Wide Key	FC/APC, 2.0 mm Narrow Key	FC/APC, 2.2 mm Wide Key	SMA	ST/PC	SC/PC ^c	LC/PC
Threading	External SM1 (1.035"-40)						

- The SM1FCA and SM1FCA2 are designed with a 4° mechanical angle to compensate for the refraction angle of the output beam.
- These adapters can only be threaded in place with the connector facing away from the internal threading.
- In certain angle-independent applications, this adapter may also be used with SC/APC connectors.

Part Number	Description	Price	Availability
SM1FC	FC/PC Fiber Adapter Plate with External SM1 (1.035"-40) Threads, Wide Key (2.2 mm)	\$31.38	Today
SM1FCA2	NEW! Customer Inspired! FC/APC Fiber Adapter Plate with External SM1 (1.035"-40) Threads, Narrow Key (2.0 mm)	\$33.28	Lead Time
SM1FCA	FC/APC Fiber Adapter Plate with External SM1 (1.035"-40) Threads, Wide Key (2.2 mm)	\$33.28	5-8 Days
SM1SMA	SMA Fiber Adapter Plate with External SM1 (1.035"-40) Threads	\$31.38	Today
SM1ST	ST/PC Fiber Adapter Plate with External SM1 (1.035"-40) Threads	\$29.18	Today
SM1SC1	SC/PC Fiber Adapter Plate with External SM1 (1.035"-40) Threads	\$59.74	Today
SM1LC	LC/PC Fiber Adapter Plate with External SM1 (1.035"-40) Threads	\$59.74	Today

Visit the *PbSe Transimpedance Amplified Photodetector* page for pricing and availability information:
https://www.thorlabs.com/newgrouppage9.cfm?objectgroup_id=2655

