

NOTES:

1. SUBSTRATE MATERIAL:
N-BK7

2. SURFACE S2 TO BE PARALLEL WITH SURFACE S1 TO WITHIN $\leq 3\text{ARCMIN}$

3. COATING (APPLY ACROSS CLEAR APERTURE)

S1: 60% R $\pm 5\%$ @ 550nm
40% T $\pm 5\%$ @ 550nm

S2: AR R(avg) $\leq 1\%$, R(abs) $\leq 2\%$ @ 400 - 700nm

4.  CUT WITH 0.25mm MAXIMUM EDGE CHIP

5. ROHS COMPLIANT

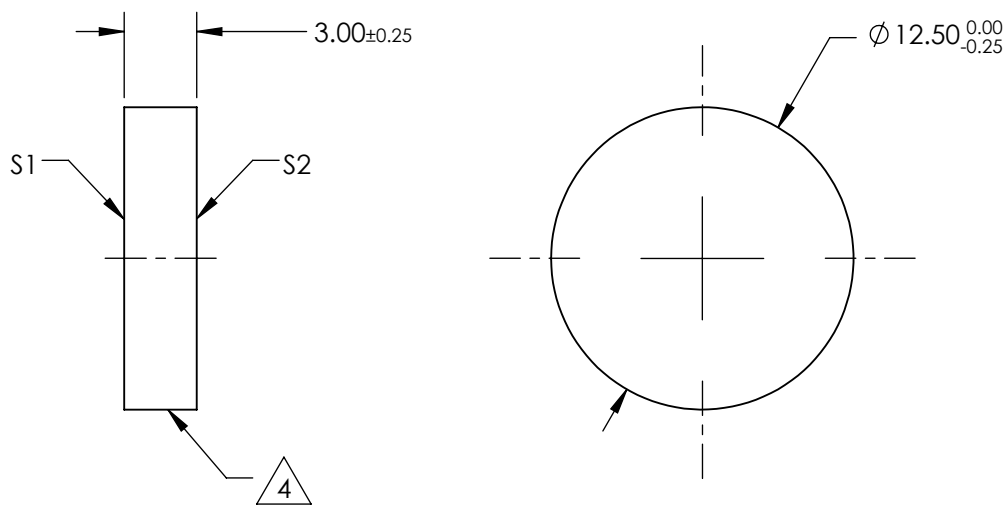

**FOR INFORMATION ONLY:
DO NOT MANUFACTURE
PARTS TO THIS DRAWING**

SPECIFICATIONS SUBJECT TO CHANGE WITHOUT NOTICE
DIMENSIONS ARE FOR REFERENCE ONLY

	S1	S2
SHAPE	PLANO	PLANO
ANGLE OF INCIDENCE	45°	45°
SURFACE QUALITY	60-40	60-40
SURFACE FLATNESS	1λ PER 25mm	1λ PER 25mm

THIRD ANGLE PROJECTION 

ALL DIMS IN mm

 **Edmund Optics®**

TITLE Ø12.5mm, 40 R/60 T, PLATE BEAMSPLITTER

DWG NO 68399

SHEET 1 OF 1