

THE INFORMATION CONTAINED IN THIS DRAWING IS SENSITIVE AND PROPRIETARY AND IS THE SOLE PROPERTY OF COVEGA CORPORATION. ANY REPRODUCTION IN PART OR IN WHOLE WITHOUT THE WRITTEN PERMISSION OF COVEGA CORPORATION IS PROHIBITED.

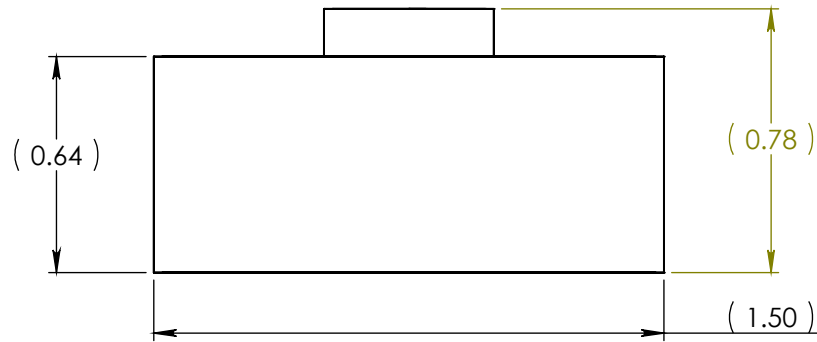
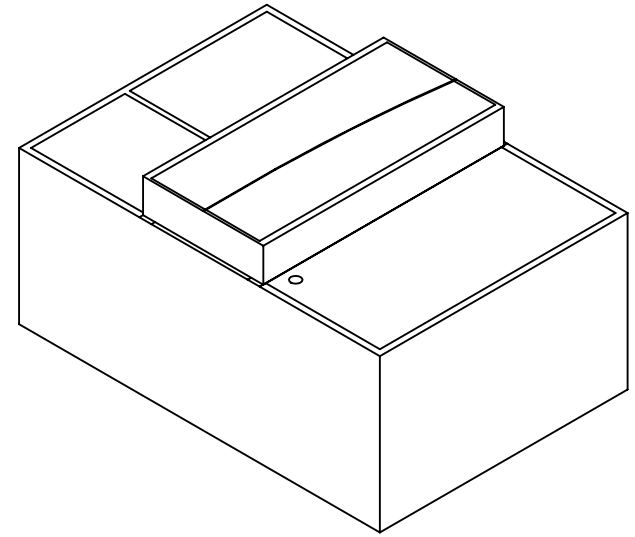
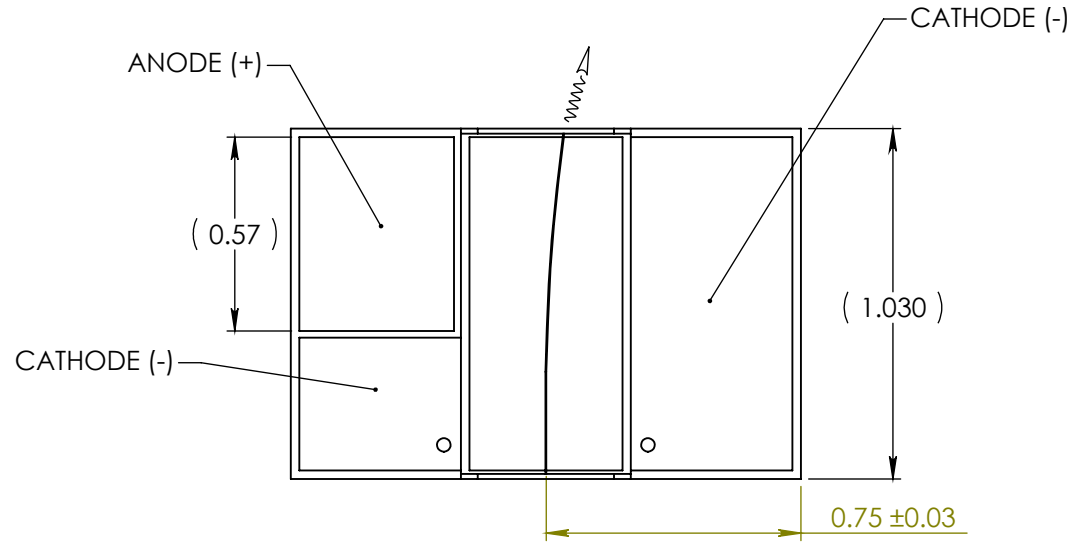

UNLESS OTHERWISE SPECIFIED:
DIMENSIONS ARE IN MM.
TOLERANCES ARE:
DECIMALS ANGLES
.XXX ± 0.025 ± 1
.XX ± 0.075
.X ± 0.125
REMOVE ALL BURRS AND BREAK
SHARP EDGES 0.1 MAX.

MATERIAL -----
FINISH -----

THIRD ANGLE PROJECTION	
APPROVALS	DATE
DRAWN	
CHECKED	
ENGINEER	
APPROV	CCB
DO NOT SCALE DRAWING	

COVEGA CORPORATION
10335 GUILFORD ROAD, JESSUP MD 20794

SAF1126C

SIZE A Doclog. NO. 19561 REV. A

SCALE 50:1 CADFILE: SAF1126C SHEET 1 OF 1