

NOTES:

1. SUBSTRATE MATERIAL:
FLOAT GLASS
2. ROHS COMPLIANT
3. COATING (APPLY ACROSS CLEAR APERTURE)

S1: 40% R $\pm 5\%$ @ 550nm
60% T $\pm 5\%$ @ 550nm

S2: 1/4 WAVE MgF2 @ 550nm

4.  EDGES CUT

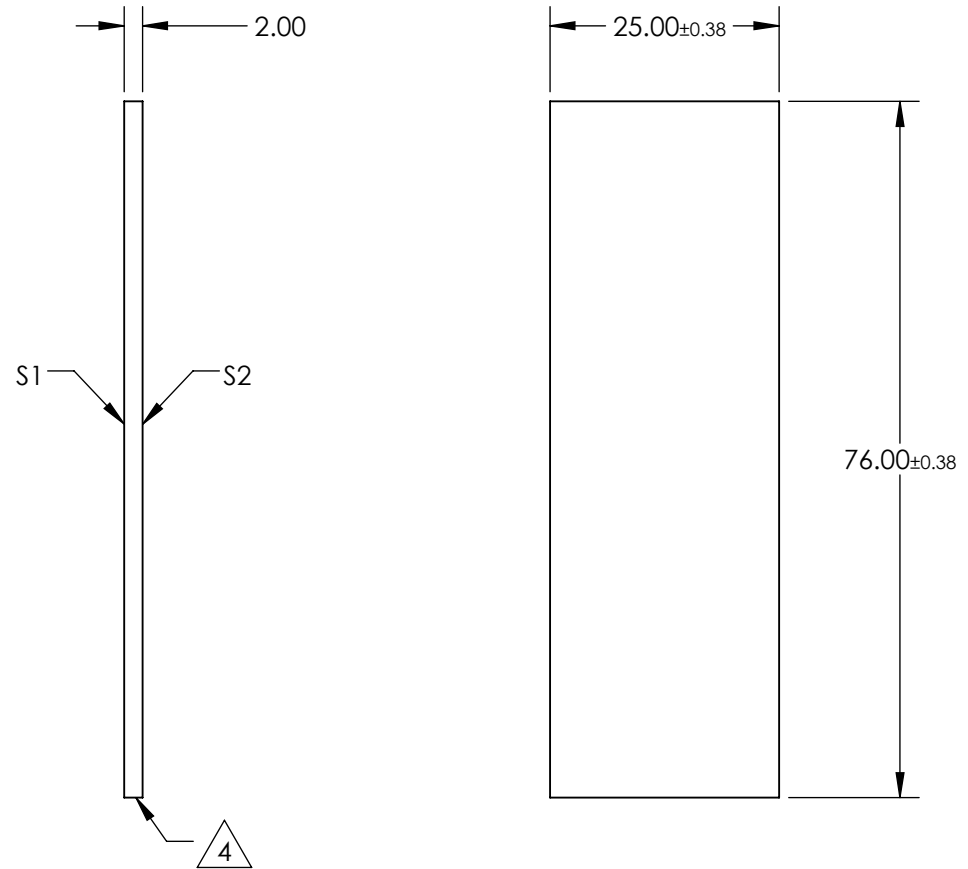

**FOR INFORMATION ONLY:
DO NOT MANUFACTURE
PARTS TO THIS DRAWING**

SPECIFICATIONS SUBJECT TO CHANGE WITHOUT NOTICE
DIMENSIONS ARE FOR REFERENCE ONLY

REV. A	S1	S2
SHAPE	PLANO	PLANO
SURFACE QUALITY	80-50	80-50
SURFACE FLATNESS	4 - 6λ	4 - 6λ
BEVEL	PROTECTED AS NEEDED	PROTECTED AS NEEDED

THIRD ANGLE PROJECTION 

ALL DIMS IN mm

 **Edmund Optics®**

TITLE

25 x 76mm, 40 R/60 T, PLATE BEAMSPLITTER

DWG NO

46672

SHEET
1 OF 1