

NOTES:

1. SUBSTRATE: GERMANIUM (Ge)
2. SURFACE S2 TO BE PARALLEL OT SURFACE S1 TO WITHIN 1 ARCMIN
3. ENVIRONMENTAL REQUIREMENTS:

S1: DLC COATING

ADHESION: PER MIL-M-13508C PARA 4.4.6  
 ABRASION: SEVERE PER MIL-C-675C PARA 4.5.10  
 HUMIDITY: PER MIL-C-675C PARA 4.5.8  
 SALT SOLUBILITY: PER MIL-C-675C PARA 4.5.7  
 SALT SPRAY: PER MIL-C-675C PARA 4.5.9  
 TEMPERATURE CYCLE: PER MIL-M-13508C PARA 4.4.4  
 WIPER: ≥5,000 WIPES OF SAND/SLURRY WITH NO REMOVAL

S2: BBAR COATING

ADHESION: PER MIL-C-48497 PARA 4.5.3.  
 ABRASION: MODERATE PER MIL-C-48497 PARA 4.5.3.3  
 HUMIDITY: PER MIL-C-48497 PARA 4.5.3.2  
 TEMPERATURE: PER MIL-C-48497 PARA 4.5.4.1  
 SOLUBILITY AND CLEANING: PER MIL-C-48497 PARA 4.5.4.2  
 WATER SOLUBILITY: PER MIL-C-48497 PARA 4.5.5.3

4. REFLECTION AND TRANSMISSION PERFORMANCE ACROSS CLEAR APERTURE ON CENTER

S2: R(AVG) ≤0.5% FROM 8.0 - 12.0μm

TRANSMISSION THROUGH COATED WINDOW:

T(AVG) ≥90% FROM 8.0 - 11.5μm  
 T(AVG) ≥88% FROM 8.0 - 12.0μm

 FINE GRIND SURFACE

6. ROHS: COMPLIANT

**FOR INFORMATION ONLY:  
 DO NOT MANUFACTURE  
 PARTS TO THIS DRAWING**

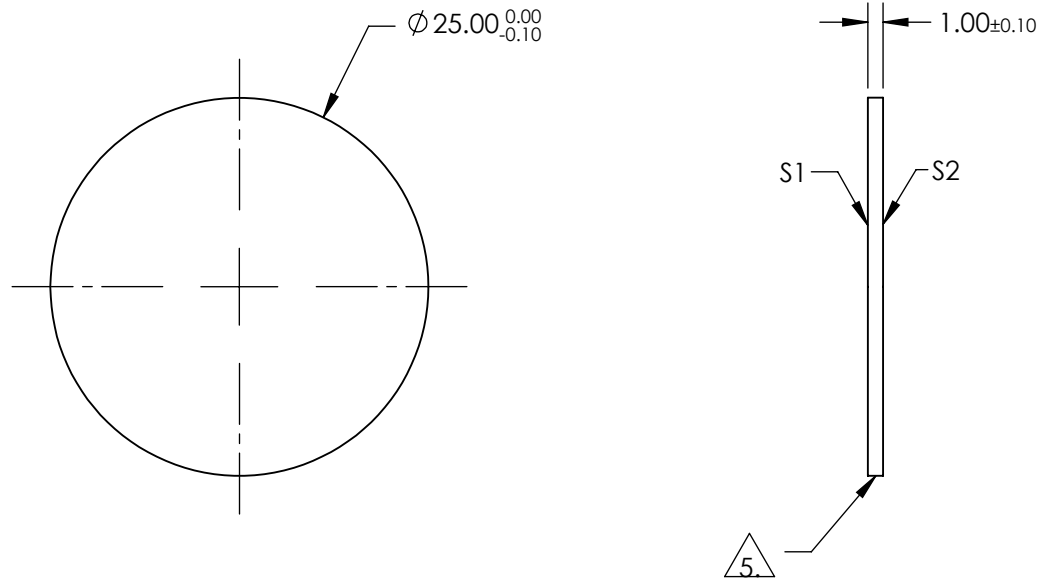

SPECIFICATIONS SUBJECT TO CHANGE WITHOUT NOTICE  
 DIMENSIONS ARE FOR REFERENCE ONLY

	S1	S2
SHAPE	PLANO	PLANO
SURFACE ACCURACY @ 10.6μm	λ/10	λ/10
SURFACE QUALITY	60-40	60-40
CLEAR APERTURE	Ø22.50	Ø22.50
BEVEL	PROTECTIVE AS NEEDED	PROTECTIVE AS NEEDED

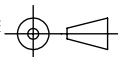
THIRD ANGLE PROJECTION 

ALL DIMS IN mm

 **Edmund Optics®**

TITLE: Ø25mm x 1mm THK DLC COATED GERMANIUM WINDOW

DWG NO: 13795

SHEET 1 OF 1