

SCALE 1:1

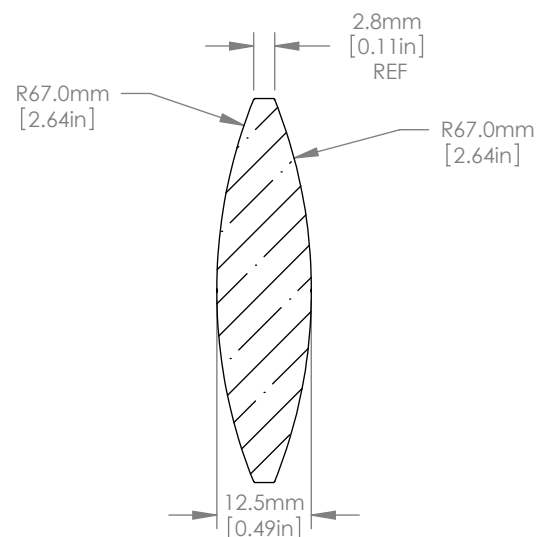
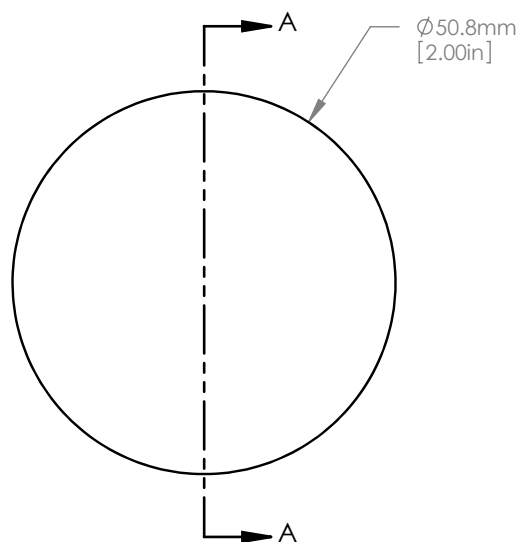

NOTES/SPECIFICATIONS:

1. DESIGN WAVELENGTH: 588nm
2. FOCAL LENGTH: $f=75.0\text{mm} \pm 1\%$
3. BACK FOCAL LENGTH(REF): $bf=70.6\text{mm}$
4. CLEAR APERTURE: $>90\%$
5. SURFACE QUALITY: 40-20 SCRATCH-DIG
6. CENTRATION: $\leq 3\text{arcmin}$
7. DIAMETER TOLERANCE: $+0.0/-0.1\text{mm}$
8. THICKNESS TOLERANCE: $\pm 0.1\text{mm}$

FOR INFORMATION ONLY
NOT FOR MANUFACTURING PURPOSES

DRAWING PROJECTION			THORLABS www.thorlabs.com D=50.8mm F=75.0mm UVFS BI CONVEX LENS	
NAME	DATE			
DRAWN	GG	15/NOV/10	MATERIAL UV GRADE FUSED SILICA	
APPROVAL	JC	13/DEC/10		
COPYRIGHT © 2010 BY THORLABS <small>VALUES IN PARENTHESIS ARE CALCULATED AND MAY CONTAIN ROUND OFF ERRORS</small>			ITEM #	APPROX WEIGHT
			LB4553	0.04 kg