

NOTES:

1. SUBSTRATE: N-BK7
2. S2 TO BE PARALLEL WITH S1 TO < 1 ARCMIN
3. COATING (APPLY ACROSS CLEAR APERTURE)
S1 & S2: R(AVG) ≤0.4% @ 425 - 675nm

4. FINE GRIND SURFACE

5. RoHS COMPLIANT

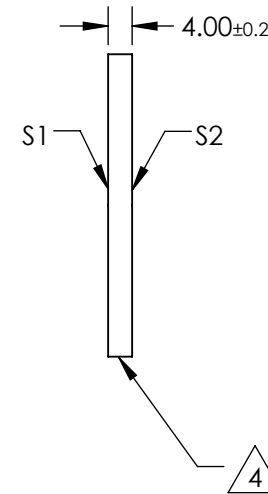
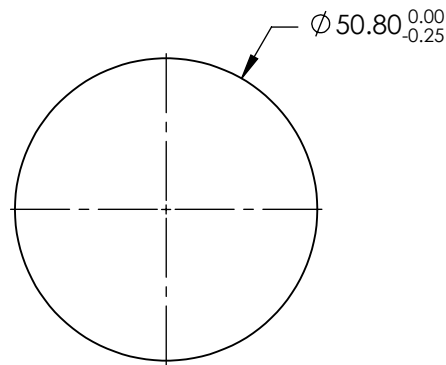
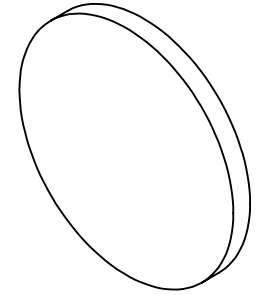

**FOR INFORMATION ONLY:
DO NOT MANUFACTURE
PARTS TO THIS DRAWING**

SPECIFICATIONS SUBJECT TO CHANGE WITHOUT NOTICE
DIMENSIONS ARE FOR REFERENCE ONLY

	S1	S2
SHAPE	PLANO	PLANO
SURFACE QUALITY	60-40	60-40
CLEAR APERTURE (mm)	Ø45.72	Ø45.72
BEVEL	PROTECTIVE AS NEEDED	PROTECTIVE AS NEEDED

THIRD ANGLE PROJECTION

ALL DIMS IN mm

EO® Edmund Optics®

TITLE

50.8mm DIA., 4mm THICK, VIS 0° COATED
λ/4 N-BK7 WINDOW

DWG NO

15434

SHEET
1 OF 1