

Preliminary

TCD1304DG

The TCD1304DG is a high sensitive and low dark current 3648 - elements linear image sensor. The sensor can be used for POS scanner.

The device consist of sensitivity CCD chip.

The TCD1304DG has electronic shutter function (ICG).

Electronic shutter funtion can keep always output voltage constant that vary with intensity of lights.

FEATURES

- Pixel Number : 3648
- Pixel Size : 8μm×200μm
- Photo Sensing Region : High Sensitive & Low Dark Current pn Photodiode
- Internal Circuit : CCD Drive Circuit
- Power Supply : Only 3.0V Drive (MIN.)
- Function : Electronic Shutter
Sample and Hold Circuit
- Package : 22 Pin CERDIP PACKAGE

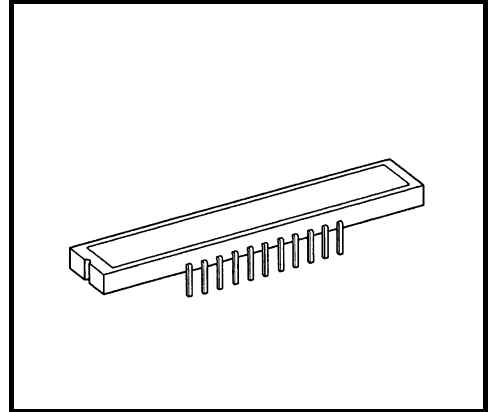

Weight: (3.5g (Typ.))

MAXIMUM RATINGS (Note 1)

CHARACTERISTIC	SYMBOL	RATING	UNIT
Master Clock Pulse Voltage	V_{fM}	- 0.3~7	V
SH Pulse Voltage	V_{SH}		
ICG Pulse Voltage	V_{ICG}		
Digital Power Supply	V_{DD}		
Analog Power Supply	V_{AD}		
Operating Temperature	T_{opr}	- 25~60	°C
Storage Temperature	T_{stg}	- 40~100	°C

Note: All voltage are with respect to SS terminals. (Ground)

PIN CONNECTION

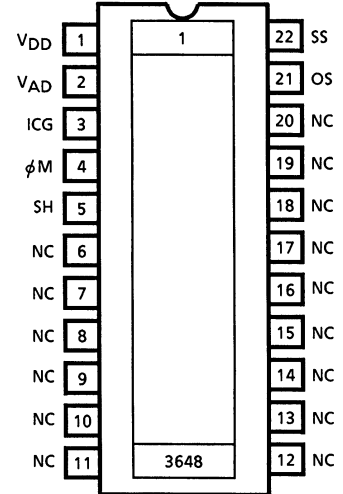

(TOP VIEW)

CIRCUIT DIAGRAM

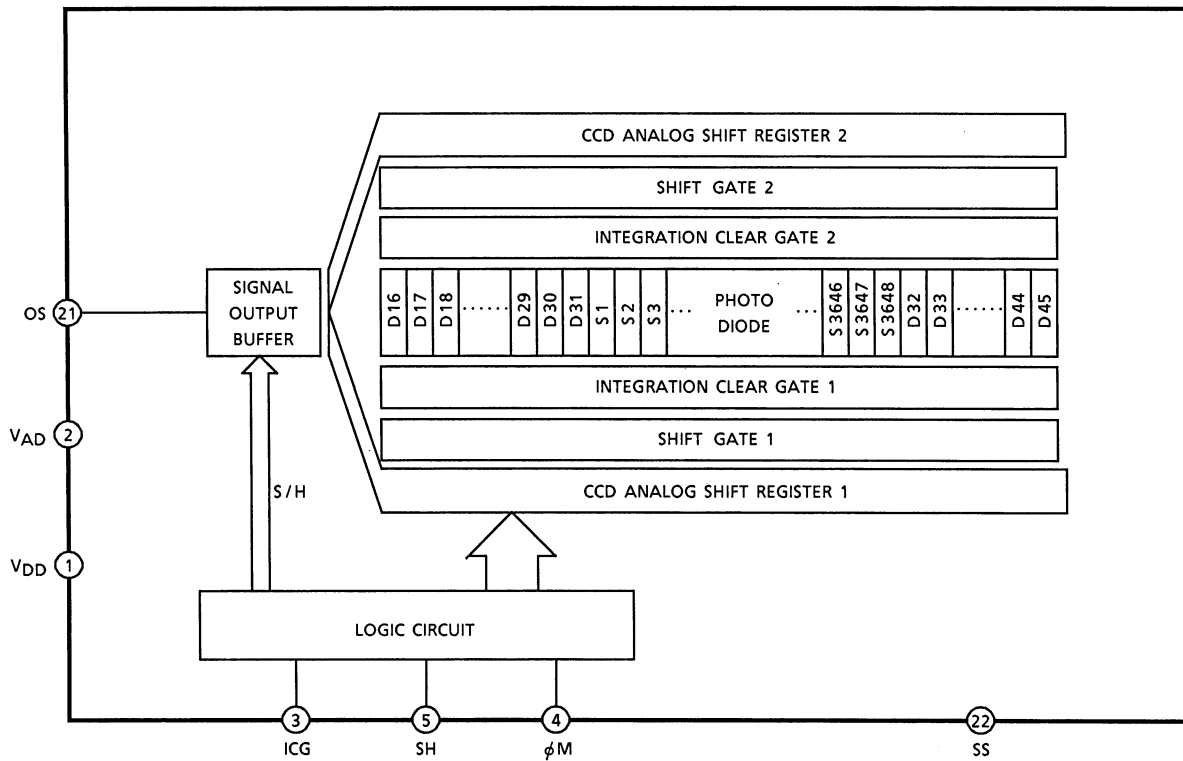

PIN NAMES

f_M	Master Clock
SH	Shift Gate
ICG	Integration Clear Gate
V_{AD}	Power (Analog)
V_{DD}	Power (Digital)
SS	Ground
NC	Non Connection

OPTICAL / ELECTRICAL CHARACTERISTICS

(Ta = 25°C, Vf = 4.0V (PULSE), ff = 0.5MHz, tINT (INTEGRATION TIME) = 10ms, LOAD RESISTANCE = 100k?, VAD = VDD = 4.0V, LIGHT SOURCE = DAYLIGHT FLUORESCENT LAMP)

CHARACTERISTIC	SYMBOL	MIN	TYP.	MAX	UNIT	NOTE
Sensitivity	R	110	160	?	V / lx·s	
Photo Response Non Uniformity	PRNU	?	?	10	%	(Note 2)
Register Imbalance	RI	?	?	3	%	(Note 3)
Saturation Output Voltage	V _{SAT}	450	600	?	mV	V _{OD} = 3.0V (Note 4)
Dark Signal Voltage	V _{MDK}	?	2	5	mV	(Note 5)
Total Transfer Efficiency	TTE	92	95	?	%	
Dynamic Range	DR	?	300	?	?	(Note 6)
Saturation Exposure	SE	?	0.004	?	lx·s	(Note 7)
DC Power Dissipation	PD	?	25	75	mW	
DC Signal Output Voltage	V _{OS}	1.5	2.5	3.5	V	(Note 8)
Output Impedance	Z _o	?	0.5	1.0	k?	
Image Lag of Electronic Shutter	VLAGICG	?	?	10	mV	Tint=100μs

Note 2: Measured at 50% of SE (Typ.)

Definition of PRNU: $PRNU = \frac{\Delta\bar{\chi}}{\bar{\chi}} \times 100(\%)$

Where $\bar{\chi}$ is average of total signal outputs and $\Delta\bar{\chi}$ is the maximum deviation from $\bar{\chi}$ under uniform illumination.

Note 3: Measured at 50% of SE (Typ.)

RI is defined as follows:

$$RI = \frac{\sum_{n=1}^{3647} |\chi_n - \chi_{n+1}|}{3647 \cdot \bar{\chi}} \times 100(\%)$$

Where $\bar{\chi}_n$ and $\bar{\chi}_{n+1}$ are signal outputs of each pixel. $\bar{\chi}$ is average of total signal outputs.

Note 4: V_{SAT} is defined as minimum saturation output voltage of all effective pixels.

Note 5: V_{MDK} is defined as maximum dark signal voltage of all effective pixels.

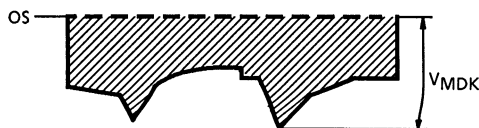

Note 6: Definition of DR : $DR = \frac{V_{SAT}}{V_{MDK}}$

V_{MDK} is proportional to t_{INT} (Integration time).

So the shorter t_{INT} condition makes wider DR value.

Note 7: Definition of SE : $SE = \frac{V_{SAT}}{R} (k \cdot s)$

Note 8: DC signal output voltage is defined as follows:

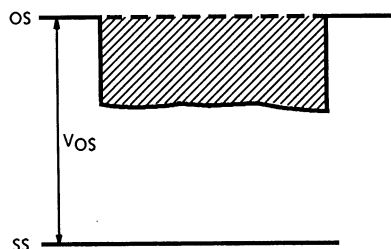

OPERATING CONDITION

CHARACTERISTIC		SYMBOL	MIN	TYP.	MAX	UNIT
Master Clock Pulse Voltage	"H" Level	V_{fM}	3.0	4.0	5.5	V
	"L" Level		0	0	0.44	
SH Pulse Voltage	"H" Level	V_{SH}	3.0	4.0	5.5	V
	"L" Level		0	0	0.44	
ICG Pulse Voltage	"H" Level	V_{ICG}	3.0	4.0	5.5	V
	"L" Level		0	0	0.44	
Digital Power Supply		V_{DD}	3.0	4.0	5.5	V
Analog Power Supply		V_{AD}	3.0	4.0	5.5	V

Note: $V_{AD} = V_{DD}$

MAX. Voltage of Pulse Voltage "H" Level = V_{DD}

MIN. Voltage of Pulse Voltage "H" Level = $V_{DD} - 0.5V$

CLOCK CHARACTERISTICS (Ta = 25°C) (V_{AD} = V_{DD}=4.0V)

CHARACTERISTIC	SYMBOL	MIN	TYP.	MAX	UNIT
Master Clock Frequency	f_{fM}	0.8	2	4	MHz
Data Rate	f_{DATA}	0.2	0.5	1	MHz
Master Clock Capacitance	C_{fM}	?	10	?	pF
Shift Pulse Capacitance	C_{SH}	?	600	?	pF
ICG Pulse Capacitance	C_{ICG}	?	250	?	pF

CLOCK CHARACTERISTICS (Ta = 25°C) (4.0V > V_{AD} = V_{DD}=3.0V)

CHARACTERISTIC	SYMBOL	MIN	TYP.	MAX	UNIT
Master Clock Frequency	f_{fM}	0.8	2	2.4	MHz
Data Rate	f_{DATA}	0.2	0.5	0.6	MHz

TIMING CHART

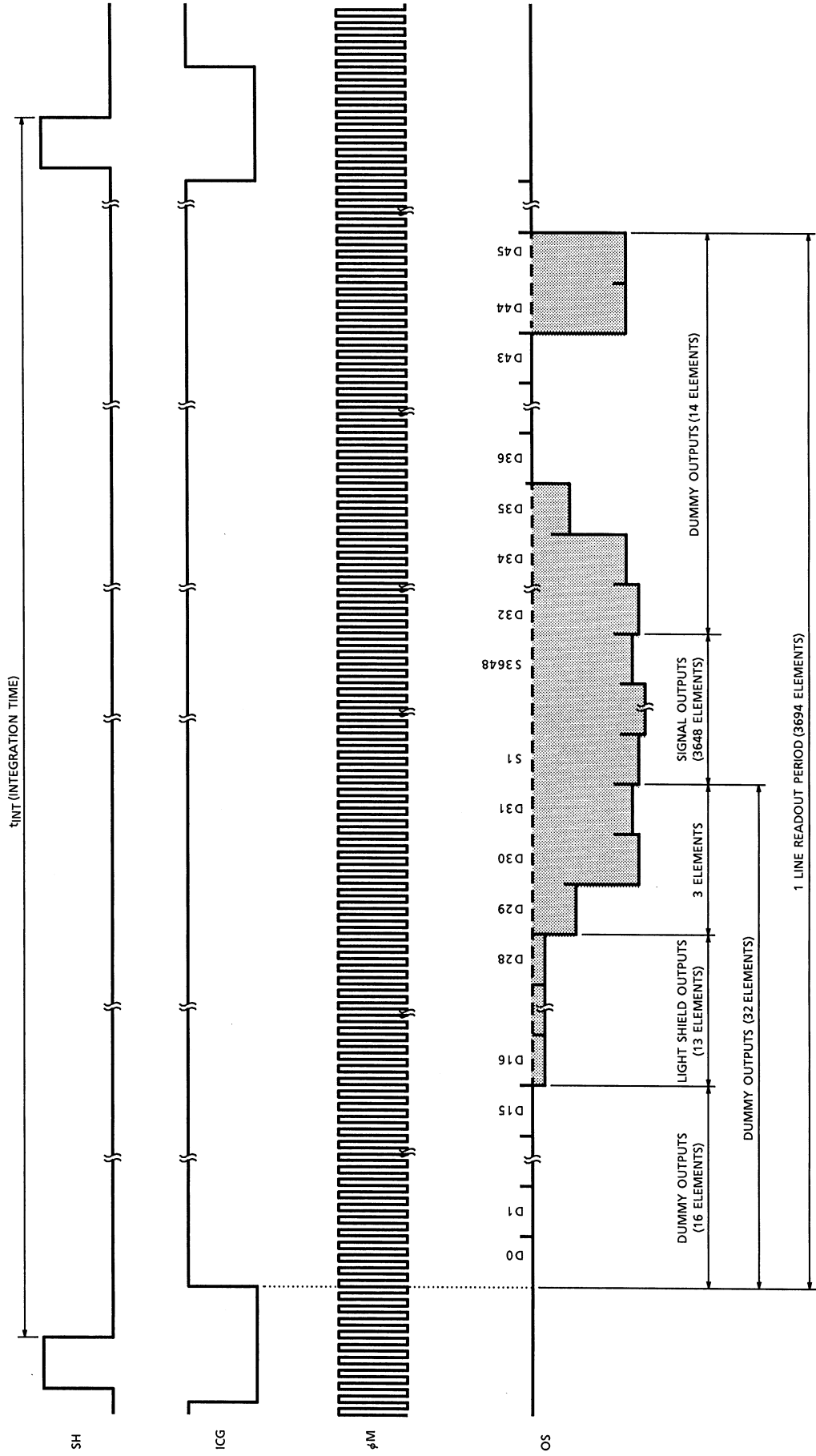

TCD1304DG-6

TIMING CHART (Use electric shutter function)

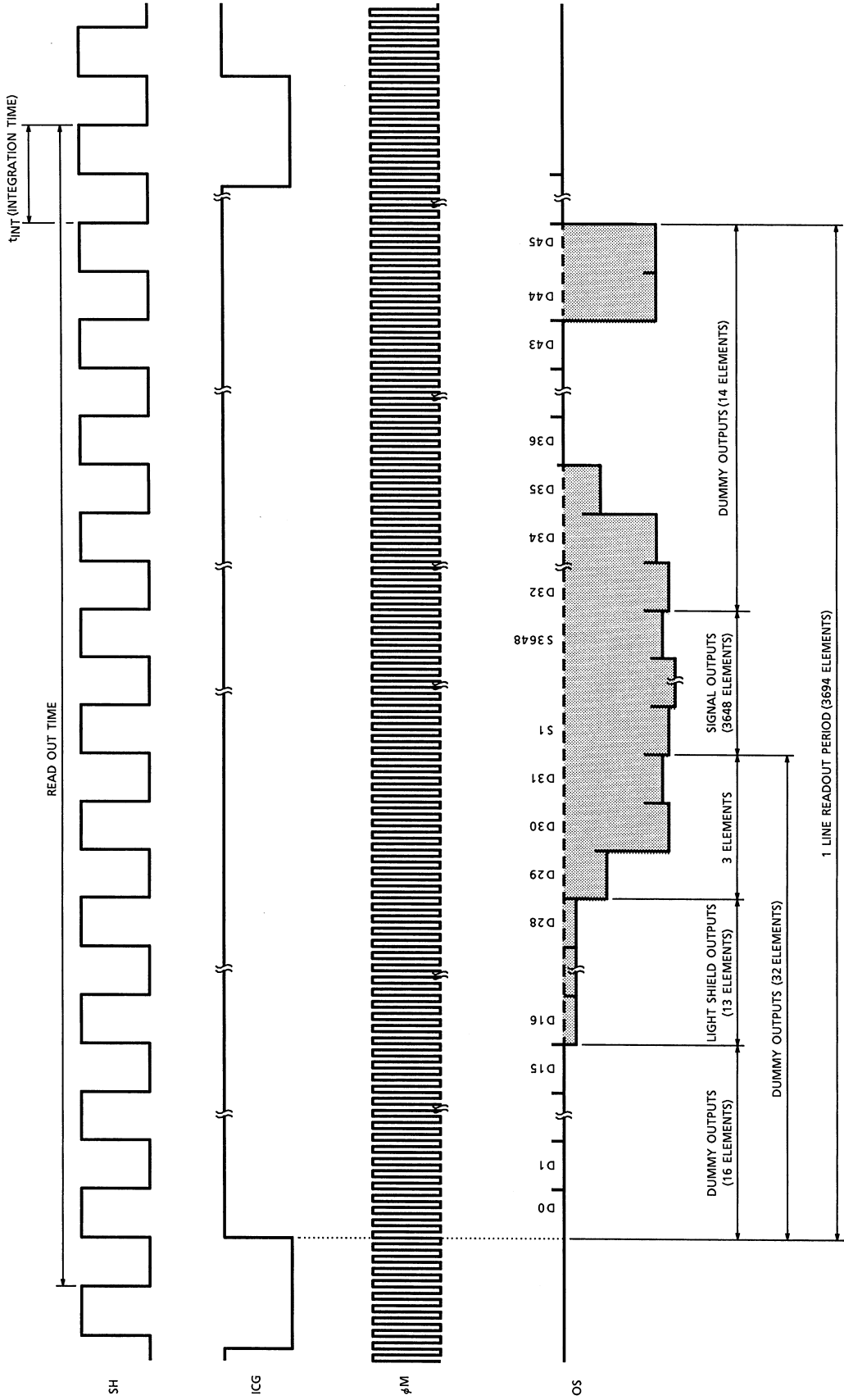

TCD1304DG-7

TIMING REQUIREMENTS

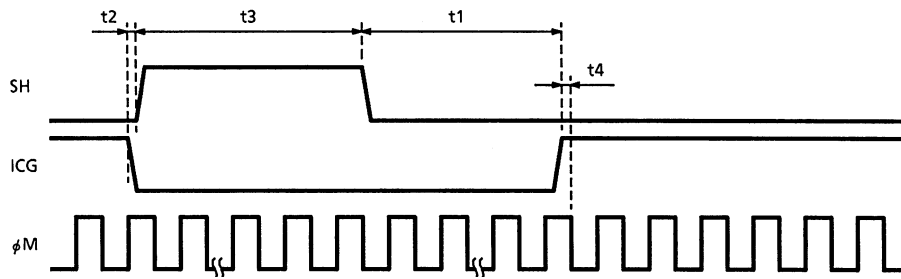

CHARACTERISTIC	SYMBOL	MIN	TYP.	MAX	UNIT
ICG Pulse DELAY	t1	1000	5000	?	ns
Pulse Timing of ICG and S H	t2	100	500	1000	ns
SH Pulse Width	t3	1000	?	?	ns
Pulse Timing of ICG and φ M	t4	0	20	*	ns

*: You keep φ M "High" Level.

Note: If you use electronic shutter function. t_{INT} (MIN.) = 10μs

USE ELECTRONIC SHUTTER

Pulse Timing of SH and ICG

- SH cycle = Tint

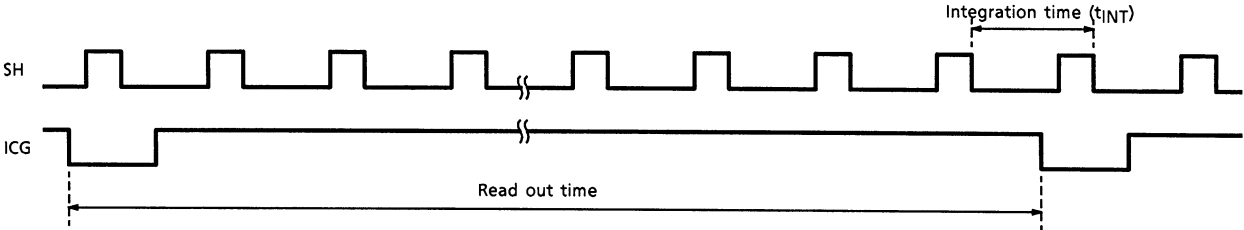

t_{INT} (MIN.) = 10μs

You have always same SH pulse width (t₃).

TYPICAL PERFORMANCE CURVES

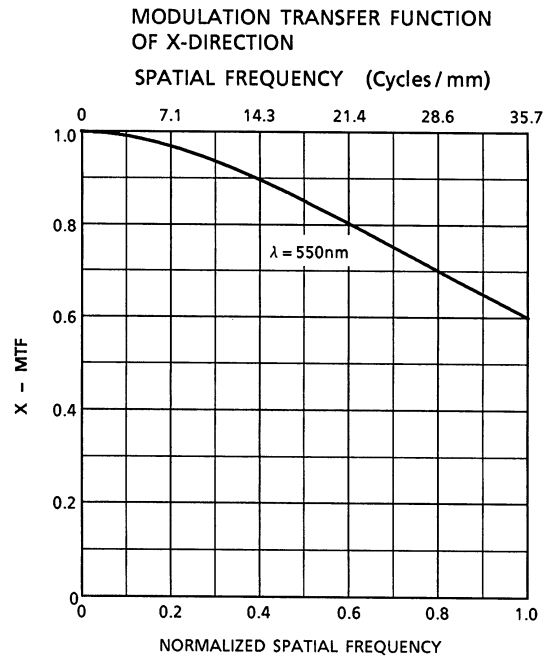
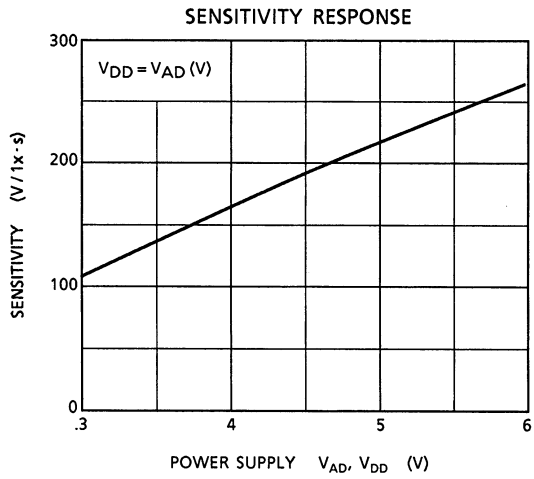
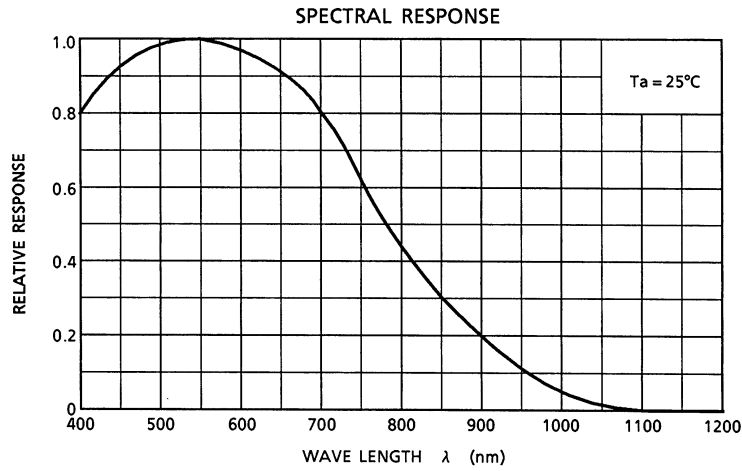

TYPICAL PERFORMANCE CURVES

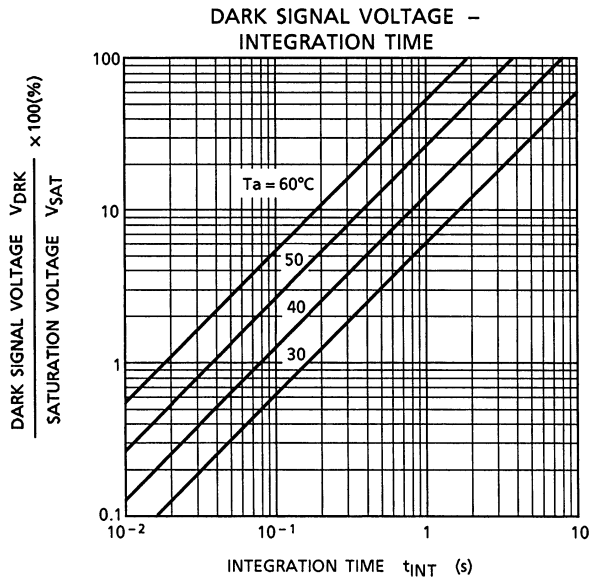
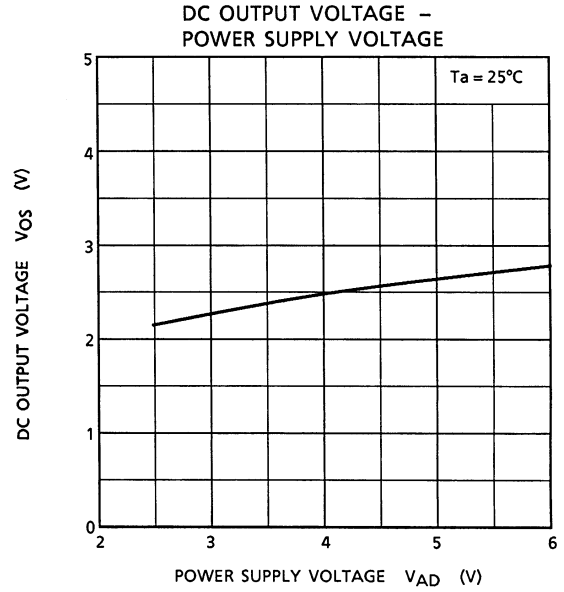
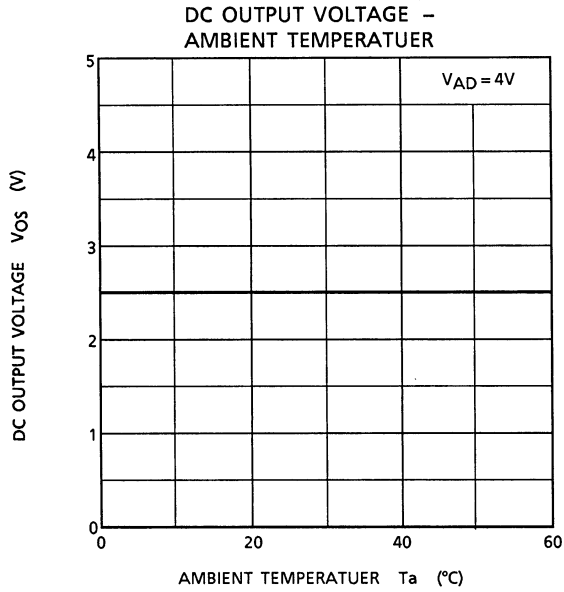

CAUTION**1. Window Glass**

The dust and stain on the glass window of the package degrade optical performance of CCD sensor.

Keep the glass window clean by saturating a cotton swab in alcohol and lightly wiping the surface, and allow the glass to dry, by blowing with filtered dry N₂. Care should be taken to avoid mechanical or thermal shock because the glass window is easily to damage.

2. Electrostatic Breakdown

Store in shorting clip or in conductive foam to avoid electrostatic breakdown.

CCD Image Sensor is protected against static electricity, but interior puncture mode device due to static electricity is sometimes detected. In handing the device, it is necessary to execute the following static electricity preventive measures, in order to prevent the trouble rate increase of the manufacturing system due to static electricity.

- a. Prevent the generation of static electricity due to friction by making the work with bare hands or by putting on cotton gloves and non-charging working clothes.
- b. Discharge the static electricity by providing earth plate or earth wire on the floor, door or stand of the work room.
- c. Ground the tools such as soldering iron, radio cutting pliers or pincer.

It is not necessarily required to execute all precaution items for static electricity.

It is all right to mitigate the precautions by confirming that the trouble rate within the prescribed range.

3. Incident Light

CCD sensor is sensitive to infrared light. Note that infrared light component degrades resolution and PRNU of CCD sensor.

4. Lead Frame Forming

Since this package is not strong against mechanical stress, you should not reform the lead frame.

We recommend to use a IC-inserter when you assemble to PCB.

5. Soldering

Soldering by the solder flow method cannot be guaranteed because this method may have deleterious effects on prevention of window glass soiling and heat resistance.

Using a soldering iron, complete soldering within ten seconds for lead temperatures of up to 260°C, or within three seconds for lead temperatures of up to 350°C.

PACKAGE DIMENSIONS

Unit : mm

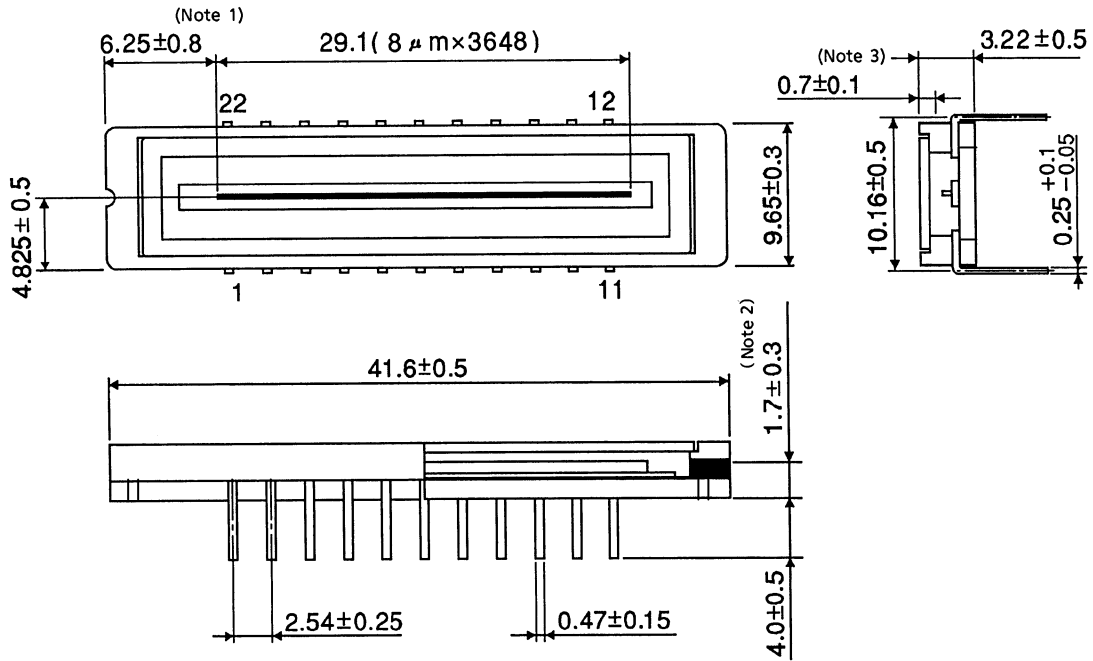

Note 1: No. 1 SENSOR ELEMENT (S1) TO EDGE OF PACKAGE.

Note 2: TOP OF CHIP TO BOTTOM OF PACKAGE.

Note 3: GLASS THICKNES ($n = 1.5$)

Weight: (3.5g (Typ.))

RESTRICTIONS ON PRODUCT USE

000707EBA

- TOSHIBA is continually working to improve the quality and reliability of its products. Nevertheless, semiconductor devices in general can malfunction or fail due to their inherent electrical sensitivity and vulnerability to physical stress. It is the responsibility of the buyer, when utilizing TOSHIBA products, to comply with the standards of safety in making a safe design for the entire system, and to avoid situations in which a malfunction or failure of such TOSHIBA products could cause loss of human life, bodily injury or damage to property.
In developing your designs, please ensure that TOSHIBA products are used within specified operating ranges as set forth in the most recent TOSHIBA products specifications. Also, please keep in mind the precautions and conditions set forth in the "Handling Guide for Semiconductor Devices," or "TOSHIBA Semiconductor Reliability Handbook" etc..
- The TOSHIBA products listed in this document are intended for usage in general electronics applications (computer, personal equipment, office equipment, measuring equipment, industrial robotics, domestic appliances, etc.). These TOSHIBA products are neither intended nor warranted for usage in equipment that requires extraordinarily high quality and/or reliability or a malfunction or failure of which may cause loss of human life or bodily injury ("Unintended Usage"). Unintended Usage include atomic energy control instruments, airplane or spaceship instruments, transportation instruments, traffic signal instruments, combustion control instruments, medical instruments, all types of safety devices, etc.. Unintended Usage of TOSHIBA products listed in this document shall be made at the customer's own risk.
- The products described in this document are subject to the foreign exchange and foreign trade laws.
- The information contained herein is presented only as a guide for the applications of our products. No responsibility is assumed by TOSHIBA CORPORATION for any infringements of intellectual property or other rights of the third parties which may result from its use. No license is granted by implication or otherwise under any intellectual property or other rights of TOSHIBA CORPORATION or others.
- The information contained herein is subject to change without notice.