

NOTES:

- 1. SUBSTRATE:  
AS87ECO
- 2. COATING (APPLY ACROSS CLEAR APERTURE)

S1 & S2: NONE

- 3. ROHS COMPLIANT

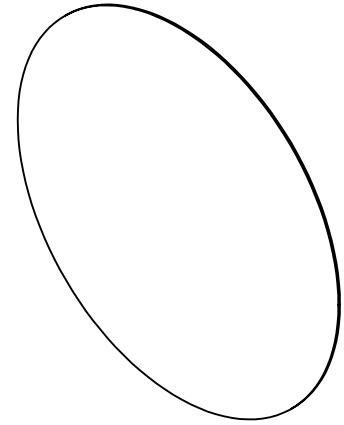
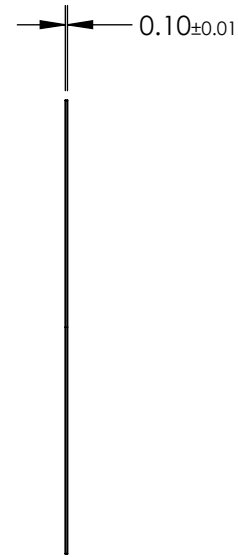
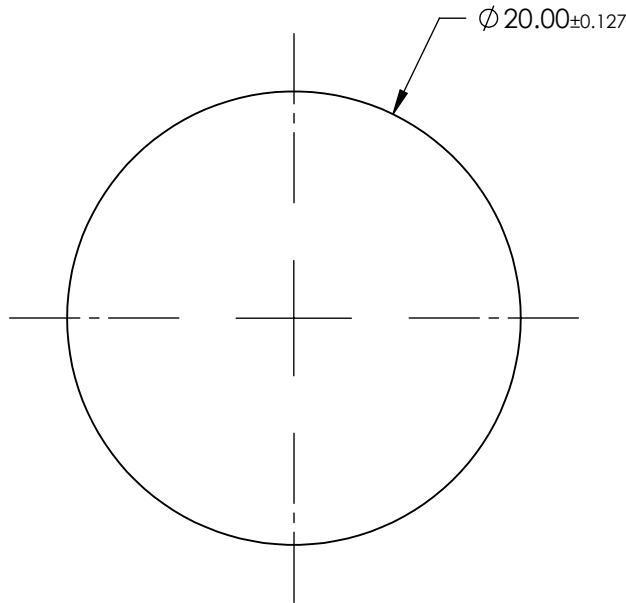

**FOR INFORMATION ONLY:  
DO NOT MANUFACTURE  
PARTS TO THIS DRAWING**

SPECIFICATIONS SUBJECT TO CHANGE WITHOUT NOTICE  
DIMENSIONS ARE FOR REFERENCE ONLY

	S1	S2
SHAPE	PLANO	PLANO
SURFACE QUALITY	80-50	80-50
SURFACE ROUGHNESS	< 0.50nm	< 0.50nm
CLEAR APERTURE	Ø 18.00	Ø 18.00
BEVEL	PROTECTED AS NEEDED	PROTECTED AS NEEDED

THIRD ANGLE PROJECTION

ALL DIMS IN mm

**EO**® Edmund Optics®

TITLE

SCHOTT AS87ECO, 20mm Dia., 0.1mm Thick,  
Ultra-Thin Window

DWG NO

20211

SHEET  
1 OF 1