

NOTES:

1. SUBSTRATE: Fused Silica (Corning 7980)
2. ROHS: COMPLIANT
3. SURFACE S2 TO BE PARALLEL TO SURFACE S1 WITHIN <5 ARCMIN
4. COATING(APPLY ACROSS CLEAR APERTURE)

S1 & S2: R(ABS) ≤1.0% @ 350 - 450nm
 R(AVG) ≤1.5% @ 250 - 700nm

5. TRANSMITTED WAVEFRONT DISTORTION: ≤ 1λ

6. FINE GRIND SURFACE

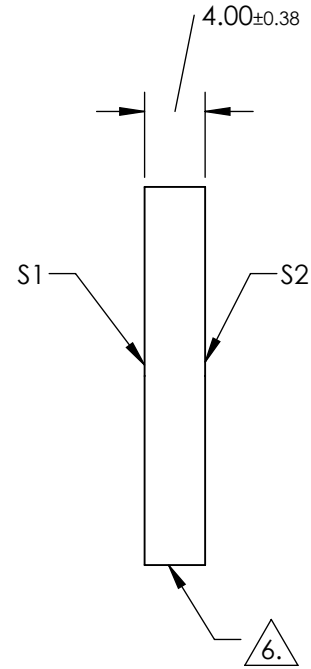
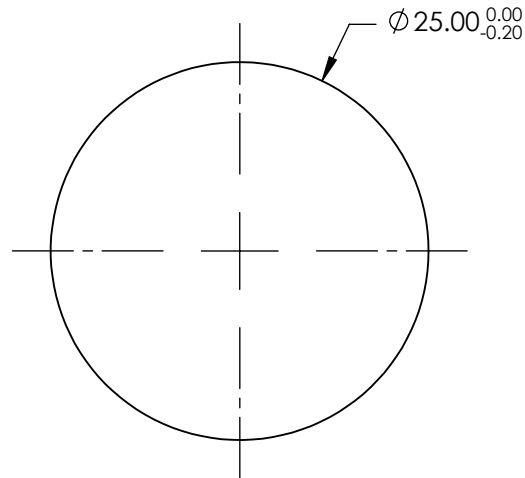
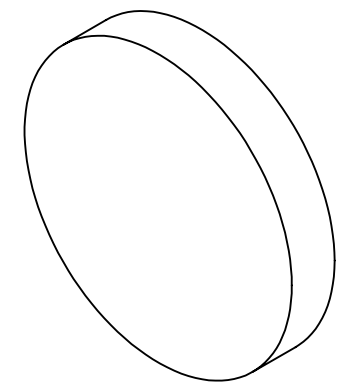

**FOR INFORMATION ONLY:
 DO NOT MANUFACTURE
 PARTS TO THIS DRAWING**

SPECIFICATIONS SUBJECT TO CHANGE WITHOUT NOTICE
 DIMENSIONS ARE FOR REFERENCE ONLY

	S1	S2
SHAPE	PLANO	PLANO
SURFACE QUALITY	60-40	60-40
CLEAR APERTURE	∅ 22.50	∅ 22.50
BEVEL	PROTECTED AS NEEDED	PROTECTED AS NEEDED



ALL DIMS IN mm

EO® **Edmund Optics**®

TITLE

25mm Dia., 4mm Thick UV-VIS Coated, 1λ
 Fused Silica Window

DWG NO

19861

SHEET
 1 OF 1