

NOTES:

- 1. SUBSTRATE: Float Glass
- 2. COATING (APPLY ACROSS CLEAR APERTURE)
 S1: Dielectric, $\pm 5\%$ R/T @ 550nm
 S2: AR 1/4 WAVE MgF2 @ 550nm

3. EDGES CUT

4. ROHS COMPLIANT

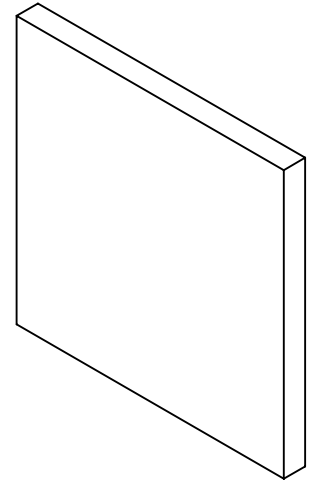
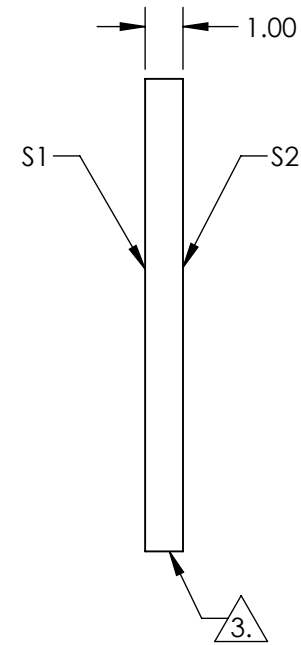
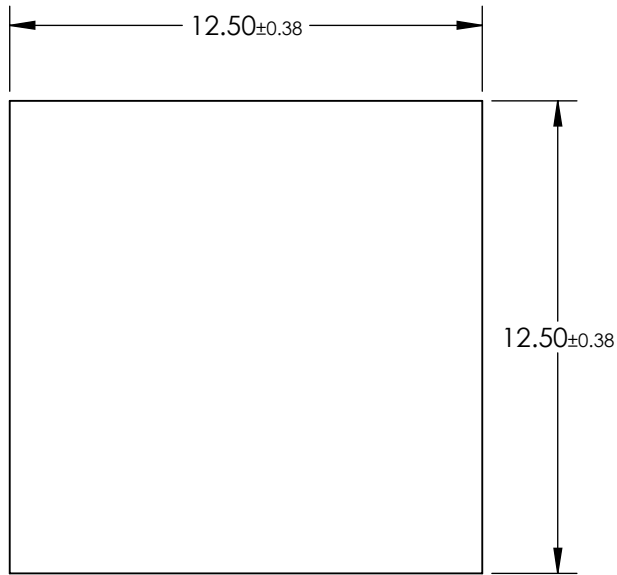

**FOR INFORMATION ONLY:
DO NOT MANUFACTURE
PARTS TO THIS DRAWING**

SPECIFICATIONS SUBJECT TO CHANGE WITHOUT NOTICE
DIMENSIONS ARE FOR REFERENCE ONLY

	S1	S2
SHAPE	PLANO	PLANO
SURFACE QUALITY	80-50	80-50
SURFACE FLATNESS	4 - 6λ	4 - 6λ
BEVEL	PROTECTED AS NEEDED	PROTECTED AS NEEDED

THIRD ANGLE PROJECTION

ALL DIMS IN mm

Edmund Optics®

TITLE

12.5 x 12.5mm, 70R/30T, AR Coated Plate
Beamsplitter

DWG NO

13400

SHEET
1 OF 1