

NOTES:

1. SUBSTRATE:
SAPPHIRE (AL2O3)
2. SURFACE S2 TO BE PARALLEL WITH SURFACE S1 TO WITHIN ≤ 3.5 ARCMIN

3. COATING (APPLY ACROSS CLEAR APERTURE)

S1 & S2: UNCOATED

4. FINE GRIND SURFACE

5. ROHS COMPLIANT

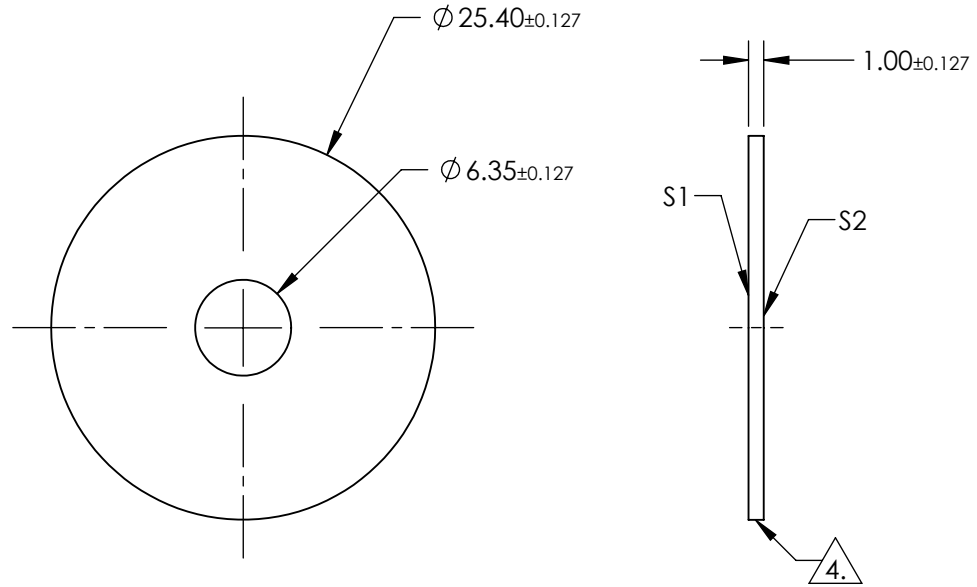
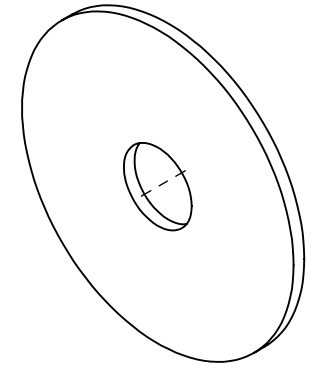

**FOR INFORMATION ONLY:
DO NOT MANUFACTURE
PARTS TO THIS DRAWING**

SPECIFICATIONS SUBJECT TO CHANGE WITHOUT NOTICE
DIMENSIONS ARE FOR REFERENCE ONLY

REV. A	S1	S2
SHAPE	PLANO	PLANO
SURFACE FLATNESS	2λ (typical)	2λ (typical)
SURFACE ROUGHNESS	$\leq 0.1\mu\text{m}$ PER INCH	$\leq 0.1\mu\text{m}$ PER INCH
SURFACE QUALITY	80-50	80-50
BIREFRINGENCE(n_o, n_e)	0.008	0.008
BEVEL	PROTECTED AS NEEDED	PROTECTED AS NEEDED

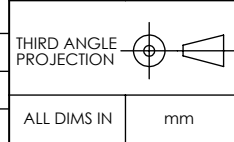

EO® Edmund Optics®

TITLE: 25.4mm Diameter, 6.35mm Through Hole, Sapphire Window

DWG NO: 17214

SHEET 1 OF 1