



Redstone™ OSA305, OSA201C, OSA202C, OSA203C, OSA205C, OSA207C Optical Spectrum Analyzers

Manual



Table of Contents

















Chapter 1	Warning Symbol Definitions	1
Chapter 2	Safety	2
Chapter 3	Warranty	3
	3.1. <i>Restriction of Warranty</i>	3
Chapter 4	Description	4
	4.1. <i>Introduction</i>	4
	4.2. <i>Interferometer Design</i>	4
	4.3. <i>Interferogram Data Acquisition</i>	6
	4.4. <i>Detector Temperature Mode (OSA203C only)</i>	6
	4.5. <i>Interferogram Data Processing</i>	7
	4.6. <i>Wavelength Meter Mode</i>	7
	4.7. <i>Wavelength Calibration and Accuracy</i>	8
	4.8. <i>Resolution and Sensitivity</i>	8
	4.9. <i>Dynamic Range/Optical Rejection Ratio</i>	10
	4.10. <i>Apodization</i>	11
	4.11. <i>Zero Fill</i>	11
	4.12. <i>Software</i>	12
	4.13. <i>Trigger (Redstone OSA305 only)</i>	12
	4.14. <i>Interlock (Redstone OSA305 only)</i>	12
Chapter 5	Using the Free-Space Input	14
	5.1. <i>Table Mounting when Using the Free-Space Input</i>	14
	5.2. <i>Activation of Alignment Beam</i>	15
	5.3. <i>Free-Space Beam Alignment Example</i>	17
	5.3.1. Initial Visual Alignment	17
	5.3.2. Adjust Software Settings	18
	5.3.3. Final Alignment	19
	5.3.4. Error Estimation	19
Chapter 6	Pure Air	20
Chapter 7	Software	21
	7.1. <i>Spectrum View and Interferogram View</i>	21
	7.1.1. Spectrum View	21
	7.1.2. Interferogram View	21
	7.1.3. Setting the Unit of the Horizontal Axis	21
	7.1.4. Setting the Unit of the Vertical Axis.....	22
	7.1.5. Displaying the Interferogram While Working in Spectrum View	22
	7.2. <i>Acquiring Data</i>	22
	7.2.1. Acquiring a Single Spectrum/Interferogram	22
	7.2.2. Repeated Measurements.....	22
	7.2.3. Automatic Setup.....	22
	7.2.4. Averaging Interferograms (Redstone OSA305 only)	22
	7.2.5. Signal	22
	7.2.6. Measurements of Pulsed Sources	23

7.2.7. Wavelength Calibration (Redstone OSA305 only).....	24
7.3. Working with Data in Traces	24
7.3.1. Trace Update Options	24
7.4. Saving and Loading Data	26
7.4.1. Saving Data.....	26
7.4.2. Loading Data.....	26
7.5. Analyzing Data.....	26
7.5.1. Wavelength Meter	26
7.5.2. Coherence Length.....	27
7.6. Scripting the ThorSpectra Software (OSA20xC only).....	27
Chapter 8 Settings.....	29
8.1. Basic Settings.....	29
8.1.1. Active Device Settings	29
8.2. Advanced Settings	29
8.2.1. Acquisition Settings.....	29
8.2.2. Environment Settings	30
8.2.3. Interferogram Settings.....	30
8.2.4. Spectrum Settings.....	31
Chapter 9 LabVIEW® Drivers.....	33
Chapter 10 Troubleshooting	34
Chapter 11 Technical data.....	35
11.1. Common Specifications.....	35
11.2. Model-Specific Specifications.....	36
11.3. Update Frequency	36
11.3.1. OSA20xC	36
11.3.2. Redstone OSA305	36
11.4. Absolute Maximum Ratings	36
11.5. Trigger Specifications (Redstone OSA305 only).....	37
11.6. Interlock Specifications (Redstone OSA305 only)	37
11.7. Internal Sources Specifications	37
Chapter 12 Mechanical Drawings.....	38
12.1. Redstone OSA305	38
12.1.1. Dimensions.....	38
12.1.2. Front and Back Panels.....	39
12.2. OSA20xC.....	40
12.2.1. Dimensions.....	40
12.2.2. Front and Back Panels.....	41
Chapter 13 Certifications and compliances	42
13.1. Redstone OSA305	42
13.2. OSA20xC	43
Chapter 14 Appendix.....	44
14.1. Calculating Absorption Cross Sections.....	44
14.2. Apodization Functions.....	45
Chapter 15 Regulatory	46

15.1. Waste treatment is your own responsibility 46
15.2. Ecological background 46
Chapter 16 Thorlabs Worldwide Contacts47

Chapter 1 Warning Symbol Definitions



Below is a list of warning symbols you may encounter in this manual or on your device.

Symbol	Description
	Direct Current
	Alternating Current
	Both Direct and Alternating Current
	Earth Ground Terminal
	Protective Conductor Terminal
	Frame or Chassis Terminal
	Equipotentiality
	On (Supply)
	Off (Supply)
	In Position of a Bi-Stable Push Control
	Out Position of a Bi-Stable Push Control
	Caution: Risk of Electric Shock
	Caution: Hot Surface
	Caution: Risk of Danger
	Warning: Laser Radiation
	Caution: Spinning Blades May Cause Harm

Chapter 2 Safety

All statements regarding safety of operation and technical data in this instruction manual will only apply when the unit is operated correctly.



SHOCK WARNING

High voltage inside. To avoid electrical shock, prior to powering on the unit, make sure that the protective conductor of the 3-conductor power cord is correctly connected to the protective earth contact of the socket outlet. Improper grounding can cause electric shock, resulting in severe injury or even death.

Do not operate without the cover installed.

CAUTION



This unit must not be operated in explosive environments.

If purging gas other than dry air is used, make sure that the environment for the operator is well ventilated since the gas will leak out from the instrument.

This product is for indoor use only. To prevent potential fire or shock hazard, do not expose the unit to any source of excessive moisture.

Only use the instrument standing on its feet.

WARNING





The OSA20xC instruments include a He-Ne laser.



The Redstone OSA305 includes a red laser and an infrared laser.





The classification of these lasers follows the European Standard IEC 60825-1:2014.

Viewing the laser output with telescopic optical instruments (for example, telescopes and binoculars) close to the aperture may pose an eye hazard! Using the instrument in combination with collimating optics may have an impact on the assigned laser classification. The safety of any system incorporating the equipment is the responsibility of the assembler of the system.

Use of controls or adjustments or performance of procedures other than those specified herein may result in hazardous radiation exposure.

Chapter 3 Warranty

Thorlabs warrants material and production of the Redstone OSA305, OSA201C, OSA202C, OSA203C, OSA205C, and OSA207C for a period of 24 months starting with the date of shipment. During this warranty period, Thorlabs will see to defaults by repair or exchange if the product is entitled to warranty. For warranty repairs or service the unit must be sent back to Thorlabs or to a place determined by Thorlabs. The customer will carry the shipping costs to Thorlabs; in case of warranty repairs Thorlabs will carry the shipping costs back to the customer. If no warranty repair is applicable, the customer also has to carry the costs for return shipment. In case of shipment from outside, EU duties, taxes, etc., that may arise have to be carried by the customer.

Thorlabs warrants the hardware and software determined by Thorlabs for this unit to operate fault-free provided that they are handled according to our requirements. However, Thorlabs does not warrant a fault-free and uninterrupted operation of the unit, of the software or firmware for special applications, or this instruction manual to be error-free. Thorlabs is not liable for consequential damages.

Please visit the below link for Thorlabs' General Terms and Conditions:

https://www.thorlabs.com/Images/PDF/LG-PO-001_Thorlabs_terms_and_%20agreements.pdf

3.1. Restriction of Warranty

The aforementioned warranty does not cover errors and defects as a result of improper treatment, software or interface not supplied by Thorlabs, modification of product, unauthorized maintenance, or misuse or operation outside the defined ambient stated by Thorlabs.

Further claims will not be consented to and will not be acknowledged. Thorlabs does explicitly not warrant the usability or the economical use for certain cases of application.

Thorlabs reserves the right to change this instruction manual or the technical data of the described unit without notice.

Chapter 4 Description

The Thorlabs Optical Spectrum Analyzer (OSA) is a general-purpose spectrum analyzer for optical research and production applications. It has a user-friendly Graphical User Interface and can be controlled from a standard PC via a High Speed USB port. Each instrument offers an FC/PC fiber input receptacle and a free-space input for collimated beams. Special designs with other input receptacles are available on request. The instrument is designed for measurements of continuous wave (CW) light sources, but works in some applications where pulsed light is used. Please contact Technical support at techsupport@thorlabs.com to discuss your application if you have a pulsed source.

4.1. Introduction

Thorlabs' Optical Spectrum Analyzers are general-purpose instruments that measure optical power as a function of wavelength. These OSA instruments are versatile enough to analyze broadband optical signals, resolve the Fabry-Perot modes of a gain chip, and identify gas absorption lines in a spectral measurement.

Whereas commonly available OSAs are typically grating-based monochromators, the Thorlabs instruments are Fourier Transform Optical Spectrum Analyzers (FT-OSAs), which utilize a scanning Michelson interferometer design, as shown in Figure 1 and Figure 2 on pages 5 and 6. This approach allows for the design of a full-featured OSA with the additional benefit of a high-precision wavelength meter.

Thorlabs offers two lines of analyzers, including the OSA20xC models and the Redstone OSA305 model. The Redstone OSA305 is a more advanced instrument for demanding applications that require a higher optical resolution or sensitivity whereas the OSA20xC instruments are general-purpose analyzers with moderate resolution and high update rate.

The Thorlabs FT-OSA has an FC/PC-style optical fiber input and a free-space input. After the input light is collimated, a beamsplitter divides the optical signal into two separate branches. The path length difference between the two branches is varied up to a maximum of 40 mm for the OSA20xC instruments or 160 mm for the Redstone OSA305. The collimated light fields then optically interfere as they recombine at the beamsplitter. The detector units shown in Figures 1 and 2 record the interference pattern, which is commonly referred to as an interferogram. This interferogram is the autocorrelation waveform of the input optical spectrum. By applying Fourier transform to the waveform, the optical spectrum is recovered. The resulting spectrum offers both a high resolution and a very broad wavelength coverage with a spectral resolution that is related to the optical delay range. The wavelength range is limited by the optical bandwidth of the detectors and of the optical coatings. The two main detectors of the Redstone OSA305 are responsive over different wavelength ranges, and the two separate spectra can be stitched together to provide a single spectrum covering the entire device wavelength range.

Furthermore, the accuracy of our system is ensured by including a frequency-stabilized HeNe reference laser in the OSA20xC models and an infrared frequency-locked reference laser in the Redstone OSA305. The reference lasers provide highly accurate measurements of optical path length changes, allowing the system to continuously self-calibrate. This process ensures accurate optical analysis well beyond what is possible with a grating-based OSA. The Redstone OSA305 also includes an additional detector and broadband source, which is used to accurately determine the location of the point of zero path difference (ZPD).

4.2. Interferometer Design

The OSA20xC models use an arrangement of two retroreflectors as shown in Figure 1. These retroreflectors are mounted on a voice-coil-driven platform, which dynamically changes the optical path length of the two branches of the interferometer simultaneously and in opposite directions. The advantage of this layout is that it changes the optical path difference (OPD) of the interferometer by four times the mechanical movement of the platform; the longer the change in OPD, the finer the spectral detail the FT-OSA can resolve.

The Redstone OSA uses a standard arrangement of one fixed and one movable retroreflector as shown in Figure 2. The mobile retroreflector is mounted on a voice-coil-driven platform, which changes the optical path length of the branch. The fixed retroreflector is mounted on a piezo actuator that translates the retroreflector in the two dimensions orthogonal to the beam path in a self-alignment algorithm. This configuration changes the OPD between the two branches by twice the mechanical movement of the platform. The Redstone OSA collects asymmetrical interferograms in terms of the ZPD, which is located significantly closer to one end of the stroke. These interferograms are usually called single-sided whereas the OSA20xC instruments collect symmetrical, or double-sided, interferograms.

The maximum physical movement of the OSA20xC platform is 10 mm from the ZPD, which translates to a maximum OPD of 40 mm and a spectral resolution of 7.5 GHz or 0.25 cm^{-1} . The Redstone OSA305 has a 80 mm stroke length capacity, and thus a maximum OPD of 160 mm and a spectral resolution of 1.9 GHz or 0.063 cm^{-1} . The wavelength resolution is dependent on the wavelength of light being measured. For more details see Section 4.8 Resolution and Sensitivity. In this context, the spectral resolution is defined according to the Rayleigh criterion and is the minimum separation required between two spectral features in order to resolve them as two separate lines. Note that when using the Wavelength Meter or Peak Track tools, the number of significant figures can far exceed the Rayleigh spectral resolution as those tools use several data points and curve fitting techniques.

The Thorlabs OSAs utilize a built-in, actively stabilized reference laser to interferometrically record the variation of the optical path length. This reference laser is inserted into the interferometer and closely follows the same path traversed by the unknown input light field. To reduce the effects of water absorption on the acquired spectrum, our OSAs have two 1/4" inner-diameter quick-connection hose fittings on the back panel, through which the interferometer can be purged with dry air or nitrogen, as detailed in Chapter 6.

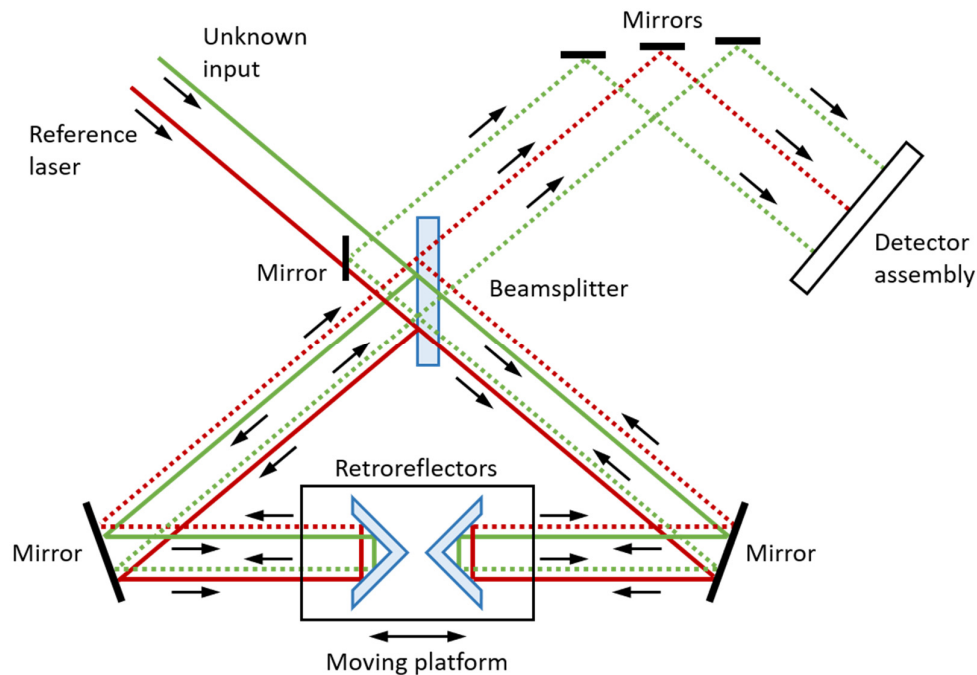

Figure 1. Optical Schematic of the Thorlabs OSA20xC Detailing the Dual Retroreflector Design

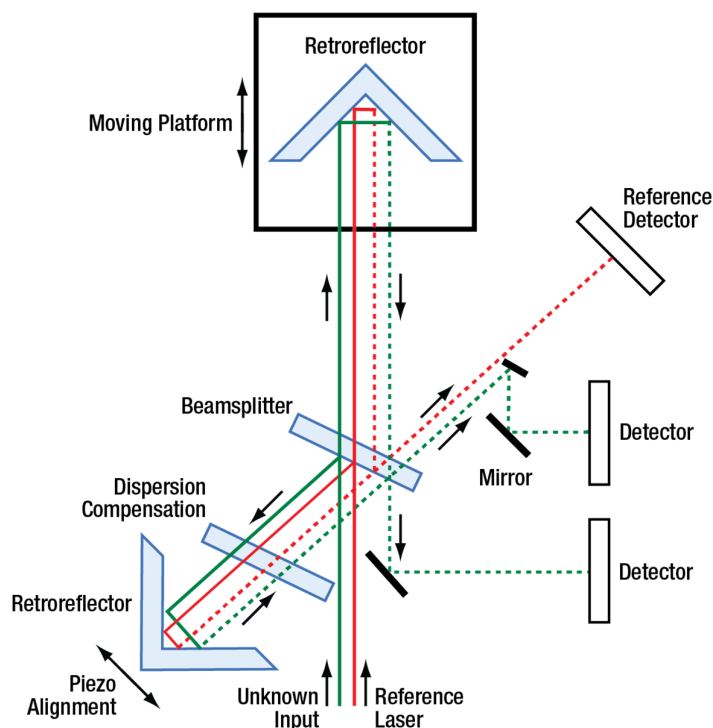

Figure 2. Optical Schematic of the Thorlabs Redstone OSA305

Note: In the OSA20xC interferometer design, both retroreflectors are attached to a common platform that is moved via a voice-coil motor. This configuration provides an optical delay that is four times the displacement of the carriage.

4.3. Interferogram Data Acquisition

The OSA20xC instruments use the interference pattern of the HeNe reference laser to clock a 16-bit Analog-to-Digital Converter (ADC) such that samples are taken at fixed, equidistant optical path length intervals. The HeNe reference fringe period is digitized, and its frequency is multiplied by a phase locked loop (PLL), which leads to an extremely fine sampling resolution. Multiple PLL filters enable frequency multiplication settings of 16X, 32X, 64X, or 128X. At the 128X multiplier setting, the data points are acquired approximately every 1 nm of carriage travel. The multiple PLL filters enable the user to choose system parameters optimized for measurements that range from high speed, reduced sensitivity, and reduced resolution to lower speed, higher sensitivity, and higher resolution.

Redstone OSA305 models instead sample the interferogram at a fixed frequency of up to 1 MHz with an 18-bit ADC while the retroreflector platform moves at a constant speed controlled by a PID loop. The data is resampled to fit up to 128 data points per reference laser period.

A high-speed USB link transfers the interferograms to the ThorSpectra software, which is highly optimized to take full advantage of modern multi-core processors, as well as top-performing graphics processing units (GPUs). The software performs a number of calculations to analyze and condition the input waveform in order to obtain the highest possible resolution and signal-to-noise ratio (SNR) at the output of the Fast Fourier transform (FFT).

Very low-noise and low-distortion detector-amplifiers with automatic gain control provide a large dynamic range, allow optimal use of the ADC, and ensure excellent SNR for up to 10 mW of input power. For low-power signals, the system can typically detect less than 100 pW from narrowband sources for mid-wavelength models and as low as femtowatts for short-wavelength models.

4.4. Detector Temperature Mode (OSA203C only)

The OSA203C features a temperature controller for the detector, which can be set to a low or a high temperature. The detector is cooled in low temperature mode, which leads to reduced thermal noise and thereby

a higher sensitivity. However, the low temperature also makes the detector insensitive to wavelengths longer than 2500 nm.

In the high temperature mode, the temperature of the detectors is stabilized at near room temperature. The thermal noise of the detector is higher in this mode than in the low temperature mode, but the higher temperature makes the detector sensitive to wavelengths longer than 2500 nm, effectively extending the operating range of the OSA203C up to 2600 nm.

When using the low temperature mode, the set point of the detector temperature control is -30°C . It is the default operating mode of the OSA203C and is enabled by default at startup. Also note that the power level calibration of the OSA203C is only guaranteed between 1000 and 2400 nm.

4.5. Interferogram Data Processing

The interferograms generated by the instrument vary from 50 thousand to 16 million data points depending on the resolution and sensitivity settings employed. The ThorSpectra software applies the user-specified apodization function, analyzes the input data and intelligently selects the optimal FFT algorithm from our internal library.

Additional software performance is realized by utilizing an asynchronous, multi-threaded approach to collecting and handling interferogram data through the multitude of processing stages required to yield spectrum information. The software's multi-threaded architecture manages several operational tasks in parallel by actively adapting to the PC's capabilities, thus ensuring maximum processor bandwidth utilization. Furthermore, a specialized GPU is tasked to perform the most advanced calculations. Each of our OSA instruments ships with a laptop computer that has been carefully selected to ensure optimum data processing and user interface operation.

4.6. Wavelength Meter Mode

When narrowband optical signals are analyzed, the OSA automatically calculates the center wavelength of the input, which can be displayed in a floating window or docked just below the main data display, presenting the overall spectrum. The central wavelength, λ , is calculated by counting interference fringes (periods in the interferogram) from both the input and reference lasers according to the following formula:

$$\lambda_{meas,vac} = \frac{m_{ref}}{m_{meas}} \cdot \frac{n_{meas}}{n_{ref}} \cdot \lambda_{ref,vac}$$

Here, m_{ref} is the number of fringes for the reference laser, m_{meas} is the number of fringes from the input laser, $\lambda_{ref,vac}$ is the vacuum wavelength of the reference laser (632.9918 nm or 1532.8323 nm), and n_{ref} is the index of refraction of air at the reference laser wavelength. n_{meas} is the index of refraction of air at the wavelength $\lambda_{meas,vac}$ and is determined iteratively from $\lambda_{meas,air}$ — that is, the measured wavelength in air — using Ciddor's formula as given by NIST¹.

The resolution of the OSA operating as a wavelength meter is substantially higher than the system when it operates as a broadband spectrometer because the system can resolve a fraction of a fringe, up to the limit set by the phase-locked loop multiplier or sampling frequency (see Section 4.3 Interferogram Data Acquisition). In practice, the resolution of the system is limited by the bandwidth and structure of the unknown input, noise in the detectors, drift in the reference laser, interferometer alignment, and other systematic errors. The system has been found to offer reliable results as low as ± 0.1 pm in the visible spectrum and ± 0.2 pm in the NIR/IR (see Chapter 11 Technical data for details).

The software evaluates the spectrum of the unknown input in order to determine an appropriate display resolution. If the data is unreliable, as would be the case for a multiple peak spectrum, the software disables the wavelength meter mode so it does not provide misleading results.

¹ See NIST's Engineering Metrology Toolbox (<https://emtoolbox.nist.gov/Wavelength/Documentation.asp>, collected 2021-08-17) for details. Even though the suggested validity range for the formula is 300 - 1700 nm, it is used by the software for the entire operation wavelength range. As suggested by NIST we assume the CO₂ concentration to be 450 $\mu\text{mol/mol}$. Older versions of the Thorlabs OSA software (v2.90 and older) use a modified version of Edlén's formula, which agrees with Ciddor's formula to less than 10^{-6} .

4.7. Wavelength Calibration and Accuracy

The OSA20xC instruments use a built-in stabilized HeNe reference laser with a vacuum wavelength of 632.9918 nm. The use of a stabilized HeNe ensures long-term wavelength accuracy as the dynamics of the stabilized HeNe are well-known and controlled. The Redstone OSA305 incorporates a frequency-locked reference laser with a vacuum wavelength of 1532.8323 nm. Because of the frequency-lock, long-term wavelength accuracy is ensured, and the reference laser is connected to an FC/APC output and can be fed into the instrument fiber input for additional calibration if so desired; see Section 7.2.7 Wavelength Calibration (Redstone OSA305 only).

The instrument is factory-aligned so that the reference and unknown input beams experience the same optical path length change as the interferometer is scanned. The effect of any residual alignment error on wavelength measurements is less than 0.5 ppm; the input beam pointing accuracy is ensured by a high-precision ceramic receptacle and a robust interferometer cavity design. No optical fibers are used within the scanning interferometer. Similarly as described in Section 4.6, each measured wavelength in the spectrum is corrected for the difference in refractive indices for the reference and measured wavelength. The refractive indices are calculated using Ciddor's formula as given by NIST with the temperature, pressure, and relative humidity measured by sensors internal to the instrument.

4.8. Resolution and Sensitivity

The resolution of this type of instrument depends on the optical path difference (OPD) between the two branches in the interferometer. In this case it is easier to work with wavenumbers (inverse centimeters, $k = 1/\lambda$) than wavelength (nanometers) or frequency (terahertz). From the Fourier transform, the relation between spectral resolution in cm^{-1} and OPD in cm is simply:

$$\Delta k = \frac{1}{OPD}$$

Assume we have two narrowband sources, such as two lasers with a 1 cm^{-1} energy difference: 6500 cm^{-1} and 6501 cm^{-1} . To distinguish between these signals in the interferogram and thus the spectrum, we would need to move the voice-coil platform from the point of zero path difference (ZPD) such that we have introduced at least 1 cm OPD. The OSA20xC can move ± 4 cm in OPD and thus spectral features 0.25 cm^{-1} apart can be resolved, while the Redstone OSA305 can move 16 cm in OPD and resolve spectral features that are 0.0625 cm^{-1} apart. The resolution of the instrument can be calculated as follows:

$$\Delta \lambda = \Delta k \times 100 \times \lambda^2$$

Here, $\Delta \lambda$ is the resolution in pm, Δk is the resolution in cm^{-1} , and λ is the wavelength in μm .

The resolution of OSA20xC instruments can be set to High or Low in the main window of the ThorSpectra software. In High resolution mode, the retroreflectors translate by the maximum of ± 1 cm (± 4 cm in OPD), while in Low resolution mode, the retroreflectors translate by ± 0.25 cm (± 1 cm in OPD). The Redstone OSA305 instrument can be set to one of four resolution modes: High, Medium High, Medium Low, or Low, which correspond to OPDs of 16 cm, 4 cm, 1 cm, and 2.5 mm, respectively. See Figure 3 for a visual comparison of the different resolutions for the OSA20xC and Redstone OSA305 instruments. In the Interferogram settings section of the ThorSpectra software, the length of the interferogram used in the calculation of the spectrum can be cut to remove spectral contributions from high-frequency components (see Section 8.2.3 Interferogram Settings).

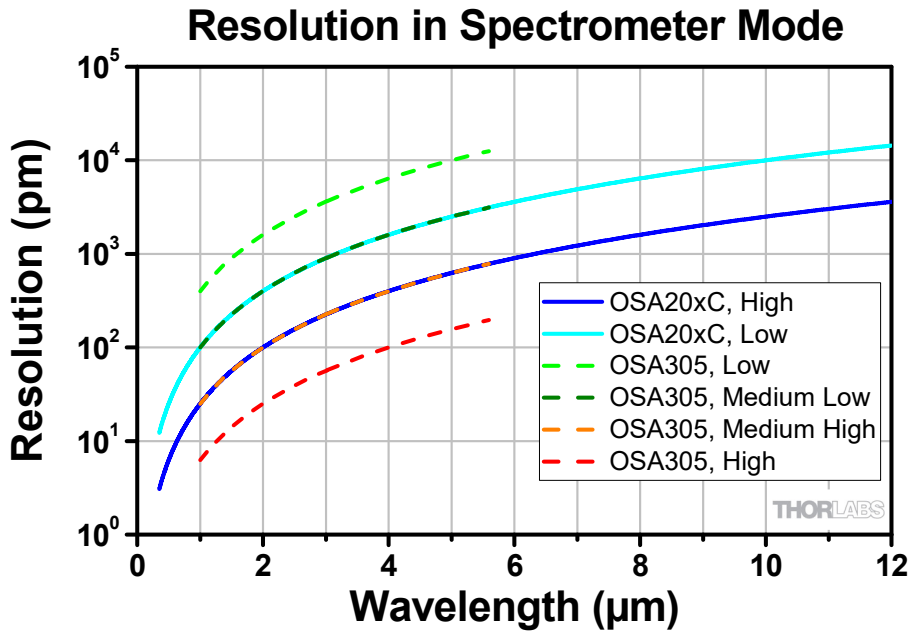

Figure 3. Resolution as a Function of Wavelength

The sensitivity of the instrument depends on the electronic gain used in the sensor electronics. Since an increased gain setting reduces the electrical bandwidth of the detectors, the instrument will run slower when higher gain settings are used. Figure 4 and Figure 5 show the dependence of the noise floor on the wavelength and OSA model.

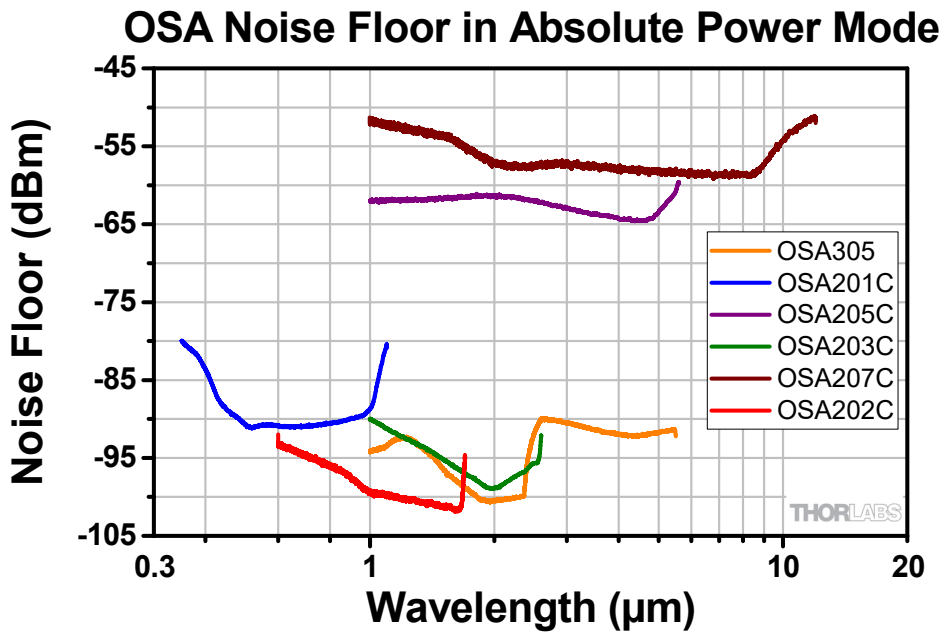

Figure 4. Noise Floor in Absolute Power Mode, i.e., the mode for measuring narrowband light sources

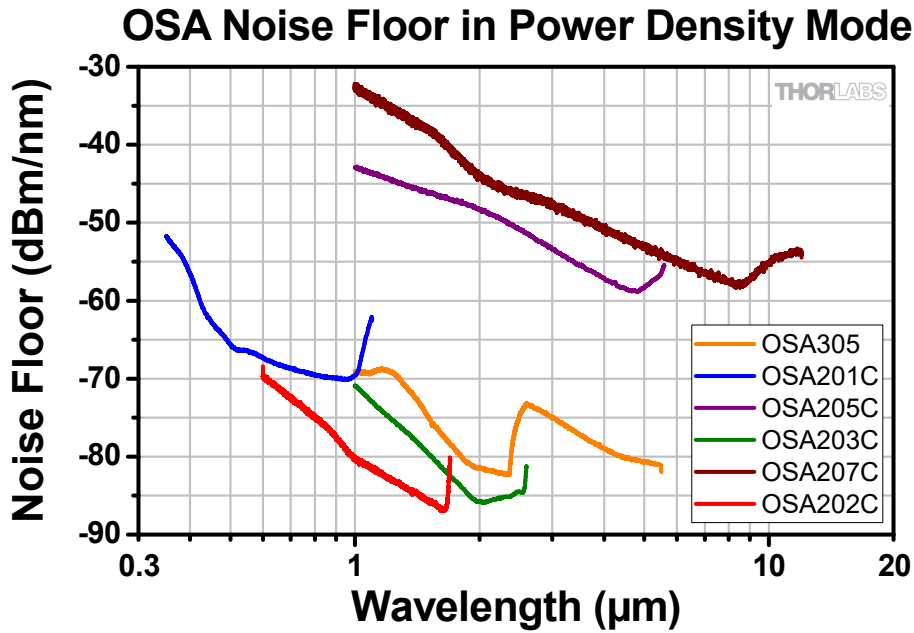

Figure 5. Noise Floor in Power Density Mode, i.e., the mode for measuring broadband light sources

4.9. Dynamic Range/Optical Rejection Ratio

The ability to measure low-level signals close to a peak is determined by the optical rejection ratio (ORR) of the instrument. It can be seen as the filter response of the OSA, and can be defined as the ratio of the power at an interesting peak to the power at a given distance from said peak. For the Thorlabs OSAs the ORR is defined with a stricter condition: instead of just considering the power at a single data point, e.g., 25 GHz from the peak, the power of the highest noise in the wavelength range from 25 GHz to 2 THz is related to the power of the peak. This way, any additional limiting peaks that are not located at the test distances will still be included in the ORR value:

$$ORR(v_{test}) = \frac{P(v_{peak})}{\max(P(v \in [v_{test}, 2 \text{ THz}]))}$$

If the ORR is not higher than the optical signal-to-noise ratio of the source to be tested, the measurement will indicate the limit of the OSA rather than the tested source. Figure 6 and the table below provide some example values for the optical rejection ratio of the OSA205C and Redstone OSA305 for a narrowband source at 1532 nm with the following settings: High Resolution, Low Sensitivity, average of 5 traces, Hann apodization, and Zero Fill = 0. All OSA20xC models and the Redstone OSA305 show similar behavior if the distance from the peak is measured in frequency, e.g., GHz.

Distance from 1532 nm Peak	Optical Rejection Ratio	
	OSA205C	Redstone OSA305
0.2 nm (25 GHz)	30 dB	40 dB
0.8 nm (100 GHz)	37 dB	42 dB
6.2 nm (800 GHz)	44 dB	45 dB
7.8 nm (1000 GHz)	44 dB	45 dB

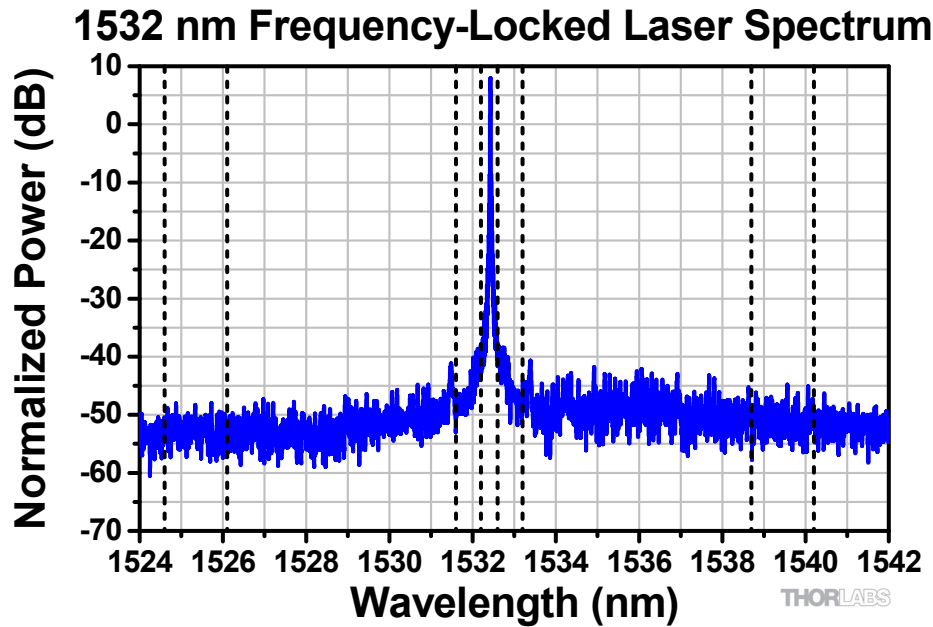

Figure 6. Spectrum of a 1532 nm Frequency-Locked Laser measured by a Redstone OSA305. The vertical lines represent where the ORR is measured.

4.10. Apodization

According to Fourier theory, the spectrum of the unknown input light can be exactly determined from the Fourier transform of the measured interferogram, but only if the interferogram is acquired over an optical path difference extending from zero to infinity. Of course, the mirrors in the OSA can only translate through a finite distance. We have therefore implemented several apodization functions in the ThorSpectra software to account for the effect of the finite path length on the measured interferogram.

The measured, finite interferogram can be thought of as an ideal, infinite interferogram that consists of measured values over a short interval (say, $-L$ to $+L$) and is equal to zero everywhere else. This treatment is equivalent to multiplying the measured interferogram (which has measured values from $-L$ to $+L$) by a boxcar function that is equal to 1 from $-L$ to $+L$ and is equal to zero everywhere else. Mathematically, the Fourier transform of the product of two functions (i.e., the interferogram and the boxcar function) is equal to the *convolution* of the Fourier transform of the first function (i.e., the interferogram) with the Fourier transform of the second function (i.e., the boxcar). That is, if $F(f)$ is defined as the Fourier transform of f , then

$$F(f \cdot g) = F(f) * F(g)$$

The Fourier transform of the interferogram is the spectrum, and the Fourier transform of a boxcar function is the sinc function: $\text{sinc}(x) \equiv \sin(x)/x$. The sinc function is an oscillating function with diminishing amplitude away from zero. Therefore, the Fourier transform of a measured, finite interferogram yields the exact spectrum, but it is convolved with additional periodic structures that are not representative of the unknown input light.

The effect of the additional periodic structures is strongest when measuring a narrowband source, because the amplitude of the interferogram of a narrowband source is high over the entire measurement range. To remove the structures, the interferogram is multiplied by apodizing (dampening) functions that decrease the amplitude of the interferogram close to the edges of the measurement range. This reduces or removes the artificial ringing at the expense of reducing the resolution of the final spectrum.

For a detailed description of the apodization functions implemented in the ThorSpectra software, please see Section 14.2 Apodization Functions.

4.11. Zero Fill

Zero filling is the process of extending the interferogram with zeros. This effectively interpolates the spectrum by adding more data points between the measured data. It is especially interesting for spectra that contain sharp

features. More data points close to a sharp spectral feature can make it easier to determine a peak's center frequency or intensity.

In the ThorSpectra software, a zero fill factor (ZFF) of 1 means that the interferogram is made twice as long (equally many zeroes as true data points) and ZFF = 2 means that the interferogram is made four times as long (three times more zeroes than data points).

It is important to note that since no real data is added, the resolution of the final spectrum does not change. This means that, for example, two peaks located close to each other in frequency would not be more resolvable if ZFF = 2 were used, rather than ZFF = 0.

4.12. Software

The OSA is shipped with the software package pre-installed on the laptop computer that is included with the purchase of this instrument. The software has a customizable graphical user interface for acquiring, inspecting, manipulating, and analyzing spectra and interferograms. The software makes it easy to locate and track spectral peaks or valleys, measure the optical input power over any wavelength range, calculate an absorption spectrum in real-time, or track a large number of parameters over time. A device interface library containing a multitude of routines for data acquisition, instrument control, and spectral processing and manipulation is also provided with the instrument. The library can be used to develop customized software for your own application using python, LabVIEW®, C/C++, C#, or other programming languages. Each OSA ships with a set of LabVIEW® routines to assist with writing user defined applications. More information on how to operate the software can be found in Chapters 8 and 9.

4.13. Trigger (Redstone OSA305 only)

At the back panel of the Redstone OSA305 instrument, there are four BNC connectors, some of which can be used to externally trigger a measurement. The four BNC connectors are labeled on the instrument back panel and provide the following functionality:

- **Trigg:** When the negative flank of a signal is registered by this input, the Redstone OSA will start an acquisition with the current settings. Note that the trigger will be ignored unless the output Aux out is low, due to the fact that the retroreflector first needs to move to the correct starting position.
- **Acquiring data:** This output will be high while the data acquisition is active.
- **Aux in:** Currently not used.
- **Aux out:** When this output is low, the instrument is ready to receive an external trigger via the Trigg input. When high, the instrument is busy.

More detailed specifications for these connectors can be found in Section 11.5 Trigger Specifications (Redstone OSA305 only).

To perform a triggered measurement, the following steps should be followed:

1. The Trigger Type combo box in the Settings menu's Acquisition tab must be set to "External."
2. Click the "Single" or "Repeat" button.
3. Check that Aux out is low and send trigger to the Trigg input.

4.14. Interlock (Redstone OSA305 only)

The Redstone OSA305 devices are equipped with a phono-type interlock jack located on the back panel. This is a laser safety feature for the internal reference laser source. To enable the reference laser source, a short circuit ($< 430 \Omega$) must be applied across the terminals of the interlock connector. The shorting device (interlock pin) installed in all units shipped from Thorlabs performs this function. Leave the shorting device installed unless using an external safety circuit or other type of remotely controlled switch to enable laser output. Making use of the interlock feature requires the appropriate 2.5 mm phono-type plug, which is readily available through most electronics retailers. The plug should be wired to the external safety circuit or switch and then plugged into the

back panel's interlock jack in place of the shorting device. The electrical specifications of the interlock jack are listed in Section 11.6 Interlock Specifications (Redstone OSA305 only).

Note that the Redstone OSA305 requires the reference laser source to collect accurate interferograms; hence, with the Interlock unplugged, the instrument is disabled.

Further, the sole output for the reference laser is the Calibration output fiber port on the front of the instrument.

Chapter 5 Using the Free-Space Input

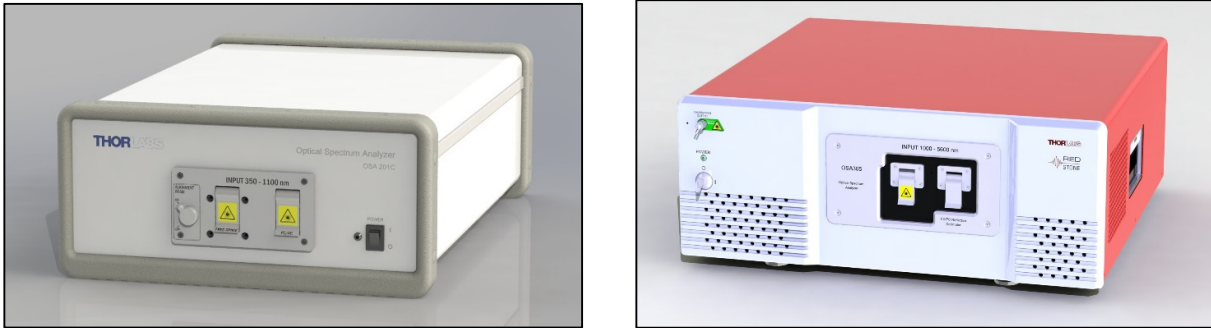

Figure 7. Front Panels of the OSA201C and Redstone OSA305

These instruments have two input options: fiber coupled and free-space. It is not possible to use both input options at the same time. By default, we provide an FC/PC receptacle for the fiber input, but other receptacles can be requested at the time of the order.

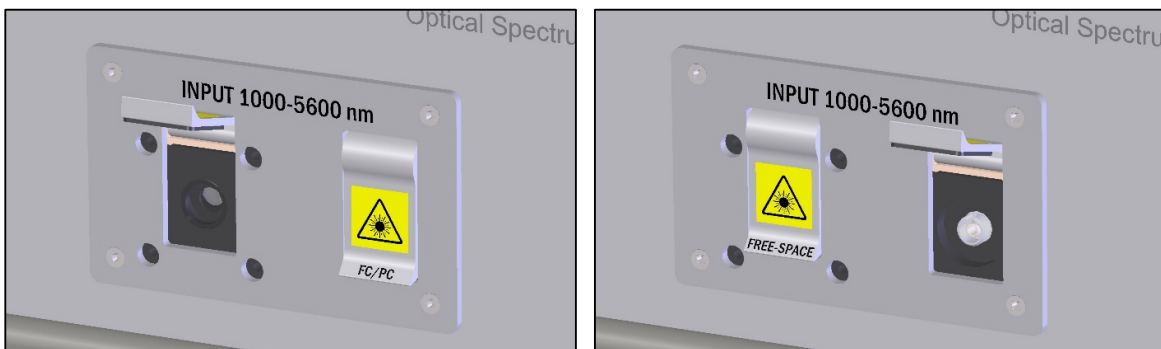

Figure 8. Free-Space Input (Left) and FC/PC Input (Right) on the OSA20xC front



Figure 9. Free-Space Input (Left) and FC/PC Input (Right) on the Redstone OSA305 front

5.1. Table Mounting when Using the Free-Space Input

The OSA20xC interferometer assembly normally “floats” on gel bushings inside the case. When coupling an external light source to the free-space input, it may be desirable to lock the interferometer to a stable surface such as an optical table. This can be accomplished by using the provided mounting feet to secure the OSA to the breadboard using two or more of Thorlabs’ CF175 clamping forks, as shown in Figure 10. Likewise, even though the Redstone OSA305 is solid, it is recommended to use two or more clamping forks when using the free-space input.

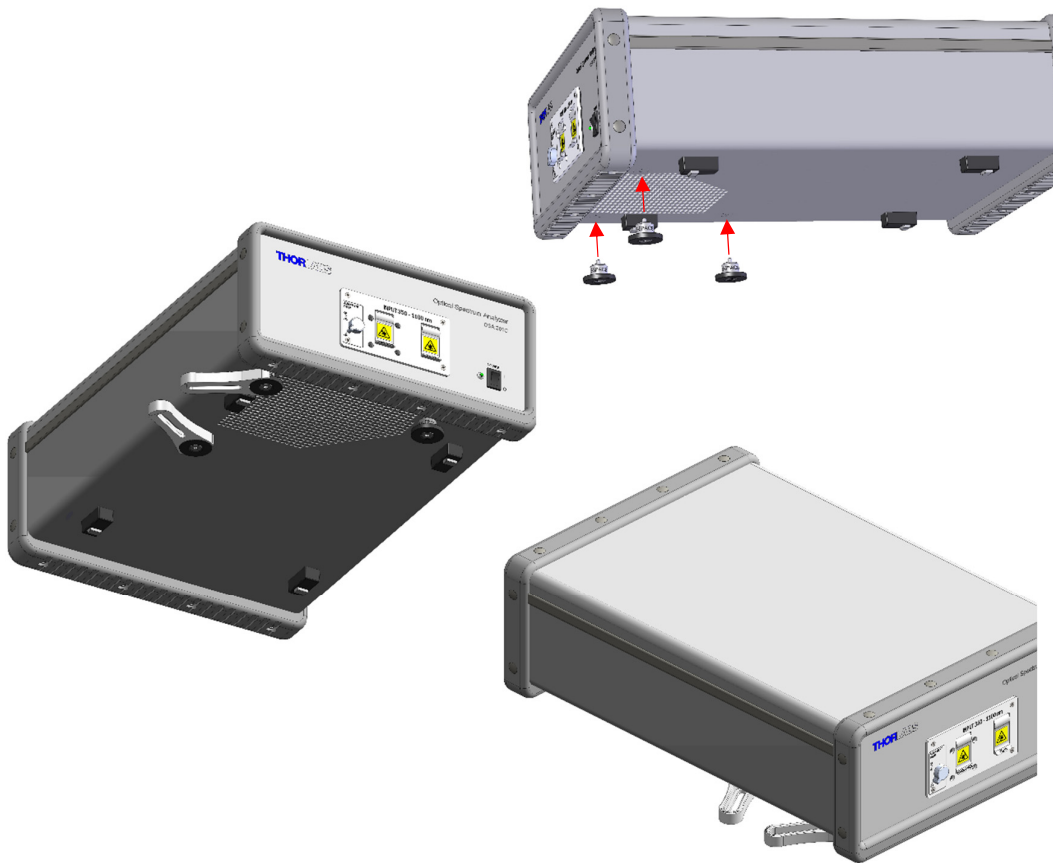

Figure 10. Three mounting feet are included with the OSA20xC. Using two CF175 clamping forks, the interferometer assembly can be locked to the table.

When the OSA20xC interferometer is locked to an optical table with the provided posts, the beam height is 61 mm (2.4") above the table surface. These fixed-height posts are long enough to extend to the table surface while also being short enough to prevent the OSA from being lifted off the table.

The Redstone OSA305 free-space input accepts a beam height of 117 mm (4.6") above the table surface.

If the beam height of your experimental setup is not consistent with the free-space input, we recommend using a periscope assembly, such as Thorlabs' RS99(/M) periscope, to adjust the beam height to that of the OSA's input. Do not use longer posts to elevate the OSA.

5.2. Activation of Alignment Beam

The OSA20xC models include a red alignment beam, which can be activated by opening the free-space door and rotating the switch on the front panel to the ON position, as shown in Figure 11. The red alignment beam will then exit the free-space input port. When the alignment beam is enabled, no measurements can be performed, and the ThorSpectra software will display the message shown in Figure 11.

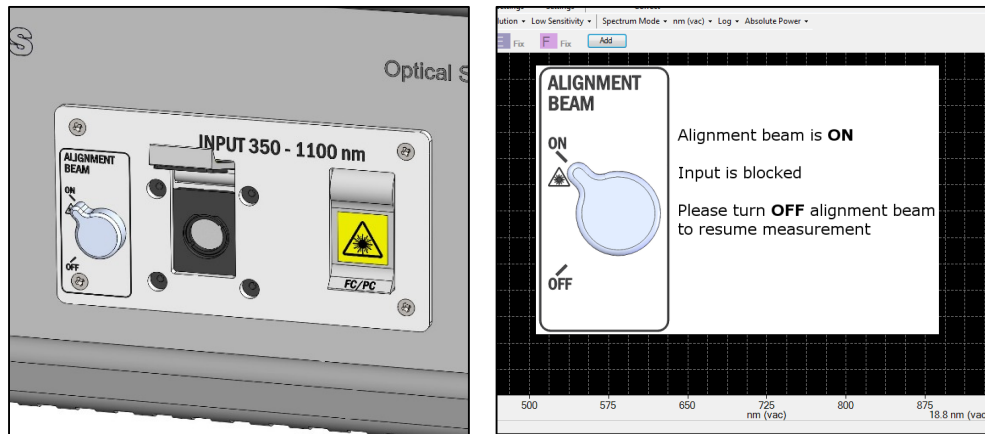

Figure 11. Alignment Beam Activation and Notification for OSA20xC Models

The Redstone OSA305 also includes a red alignment laser, which will exit the free-space port when activated with a button in the “Free-space Alignment” window (see Figure 12). When the alignment beam is activated, one optical arm of the interferometer is blocked and no interferometric measurements can be performed, and a warning message will appear in the ThorSpectra software. However, the second optical arm is not blocked and light from this arm is incident on the detectors. This “DC signal” of the detectors is available when the alignment beam is activated and can be of assistance in the alignment process.

Note that when the “Free-space Alignment” window is open, the detector offset is disabled and the saturation level is decreased. When clicking the “Done” button to close the window, the autogain algorithm will try to find gain and offset settings that optimize the interferogram signal.

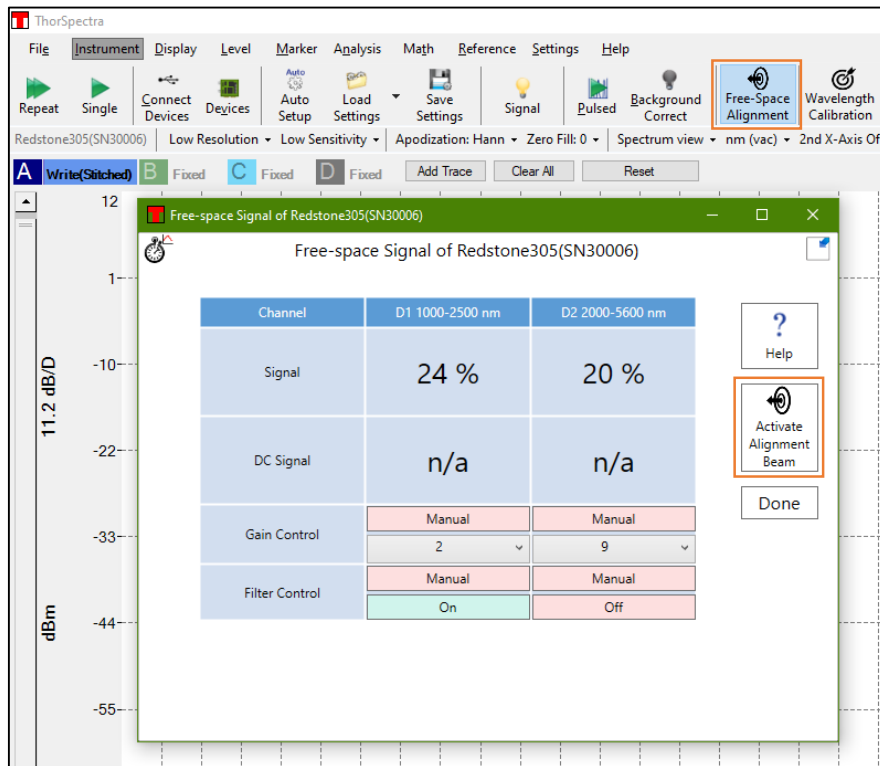

Figure 12. Alignment Beam Activation for the Redstone OSA305

The unknown input should be adjusted to be collinear to the alignment beam for optimal measurement accuracy.

To begin the procedure of aligning an external free-space light source, turn on the alignment beam and proceed with the alignment, following the instructions in Section 5.3.1. Clicking the “Help” button in the “Free-space Alignment” window in Figure 12 will open a PDF file with a tutorial with further details and examples.

5.3. Free-Space Beam Alignment Example

The following section describes the procedure for aligning the beam from an (external) source to be colinear with the OSA's beam path. The alignment beam emitted by the OSA is accessible to the user and is provided as a reference for aligning the user's free-space beam path to be colinear with the OSA's beam path. After following the instructions in Section 5.3.1 for a rough initial visual alignment, the software will guide the final alignment using instrument measurements as described in Sections 5.3.2 and 5.3.3.

5.3.1. Initial Visual Alignment

Figure 13 below shows an example alignment setup, the most important part of which is to include two mirrors in kinematic mounts. When two mirrors rather than one can be tipped and tilted, the conditions on the position of the light source are much less stringent. Use the mirror closest to the test source to steer the input source into the OSA, using a viewing card (such as Thorlabs Item # VRC2) and/or an alignment plate (such as Thorlabs Item # CPA2) to aid in the alignment. Then, use the mirror closest to the OSA to point the alignment beam emitted by the OSA at the center of the input source. Repeat these steps until the test source beam and alignment beam overlap over the entire beam path.

When activating the alignment beam on the Redstone OSA, the DC signal of the detectors will be available, the optimization of which will most often lead to good interferometric signals. Since the DC signals don't require any motor motion, the update rate is several Hz and the manual alignment process can thus be completed in a shorter amount of time.

For the OSA207C, please note that due to the optical coatings used to obtain broad wavelength operation, multiple red alignment beams may be visible. The center beam is the one to which the input IR source should be aligned.

A portion of the red alignment beam light is coupled out from the Calibration output port on the Redstone OSA front panel, which can aid in the alignment if the light source is fiber-coupled and emits outside of the visible range. The test source fiber can then be replaced by a fiber connected to the Calibration output, and the beam path of the test source is visualized.

If the input test source is sensitive to feedback from the alignment beam, position a suitable dichroic mirror as close as possible to the test source.

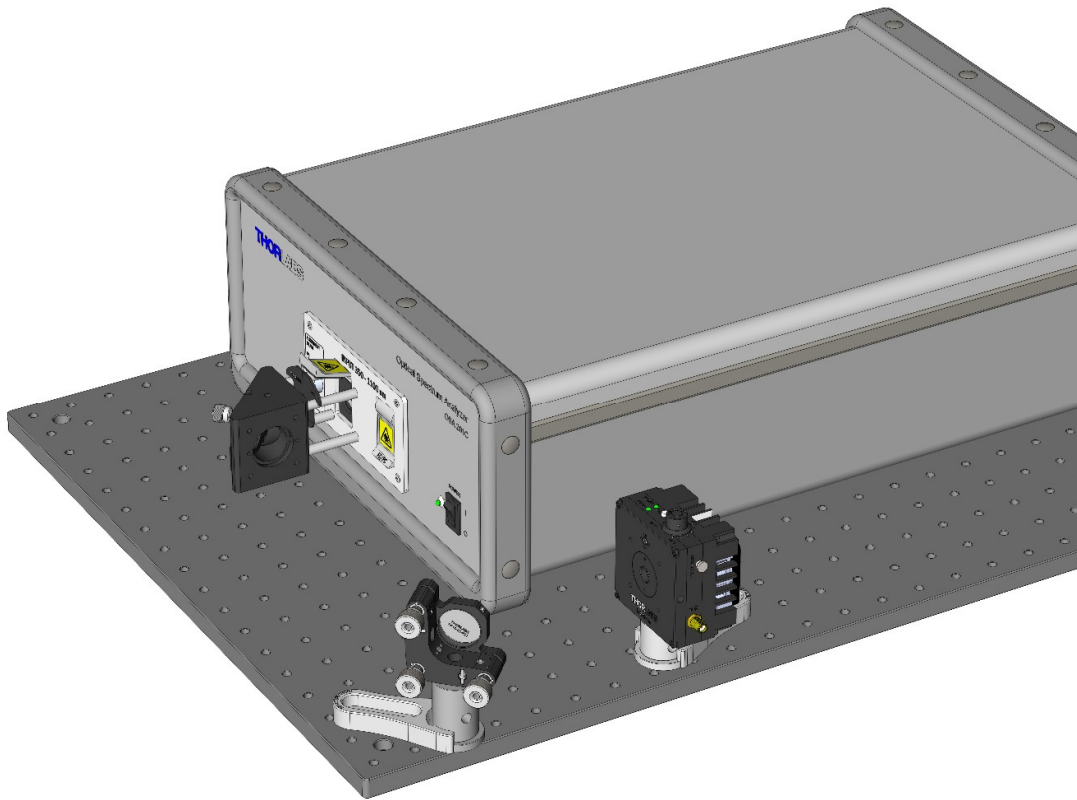

Figure 13. Example Setup for Aligning the Free-Space Input

5.3.2. Adjust Software Settings

Once the system is roughly aligned, disable the alignment beam in order to see a signal in the main software window. Change the acquisition settings to Low Resolution, and for Redstone OSA305 Low Sensitivity or for OSA20xC Medium Sensitivity. OSA20xC users should now open the “Signal” window under the Instrument menu and click the “Auto” box below the applicable detector to toggle to “Manual” mode; opening the “Free-space Alignment” window automatically manages these settings for Redstone OSA305. Adjust the gain level(s) such that a strong signal is achieved while not saturating the detector(s); a signal value in the range of 10% to 80% is suggested. It is recommended to start a time series measurement of the signal and/or power via the Long-Term functionality found in the Analysis menu to get a reading of how the signal value and detected input power changes as the two mirrors are adjusted.

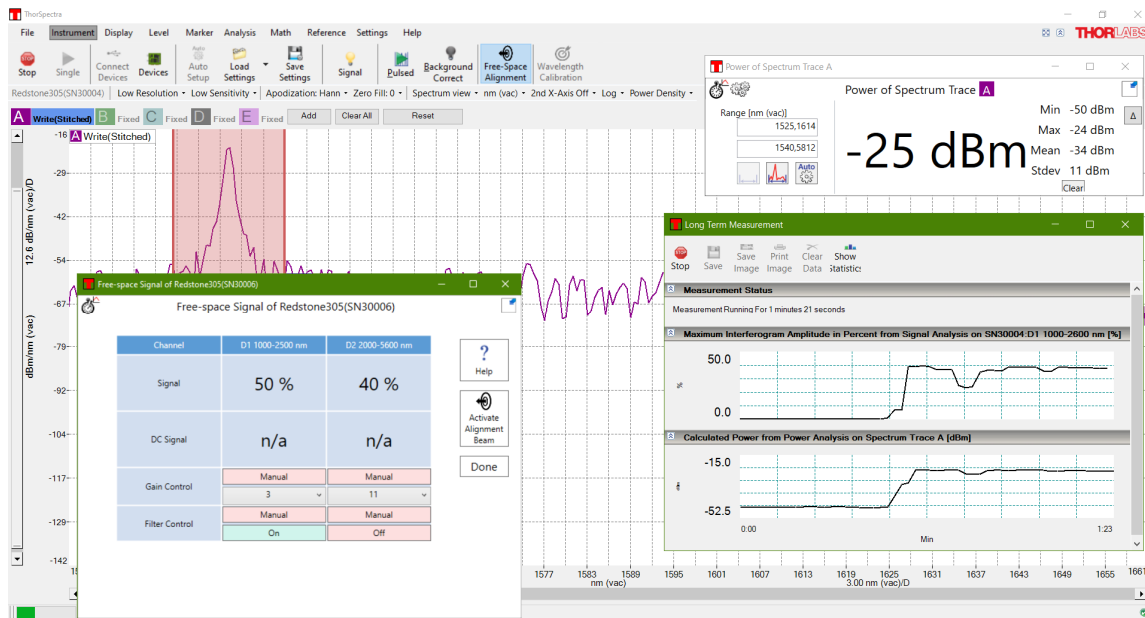

Figure 14. An Example of a Helpful Windows Layout for Free-Space Alignment

5.3.3. Final Alignment

Repeat the alignment process in Section 5.3.1, but utilize the OSA readings instead of the viewing card to optimize the alignment. Remember to decrease the gain level if any detector gets saturated. The Redstone OSA305 includes an attenuation filter in front of each detector that can be activated and deactivated with buttons in the "Free-space Alignment" window.

5.3.4. Error Estimation

When the signal cannot be optimized further, the wavelength error caused by any remaining misalignment can be calculated. Measure the offset (d) between the source exit point and the alignment beam. The wavelength error is the path difference between the alignment beam and the source beam, and can be estimated as $1 - \cos\left(\tan^{-1}\left(\frac{d}{D}\right)\right)$, where D is the distance between the source and the detector. Note: this is the total distance, i.e. including the distance inside the OSA between the free-space aperture and the detector; 45 cm for OSA20xC models and 64 cm for Redstone OSA305. It should be possible to have d better than 1 mm for $D = 1000$ mm, which yields an error of less than 5×10^{-7} (about 1 – 3 pm depending on the source wavelength range).

Chapter 6 Pure Air

OSA instruments have two hose connectors which can be connected to an external air purifier, such as Thorlabs Item # PACU Pure Air Circulator Unit. We recommend a flow rate of 2 liters/min. Simply attach two hoses (one supply and one return) to the 1/4" inner diameter quick-connections on the back of the OSA. Compatible tubing is sold as Thorlabs Item # PACU-TG.

WARNING

If purging gas other than dry air is used, make sure that the environment for the operator is well ventilated since the gas will leak out from the instrument.



Figure 15. OSA20xC 1/4" Inner Diameter Quick-Connections for a Purified Air Supply



Figure 16. 1/4" Inner Diameter Quick-Connections for a Purified Air Supply on the Redstone

Chapter 7 Software

The software, its requirements and operation, can be found in the ThorSpectra User Guide. Below are described the parts of the GUI that are specific to the OSA20x and Redstone instruments.

7.1. Spectrum View and Interferogram View

The Thorlabs OSA can be operated in one of two views: Spectrum view or Interferogram view.

7.1.1. Spectrum View

In Spectrum view,

- Only spectra are shown
- Only analysis tools and math tools applicable to spectra are enabled
- Interferograms are still acquired in the background but will not be displayed until Interferogram view is selected

7.1.2. Interferogram View

In Interferogram view,

- Only interferograms are shown
- Only analysis tools and math tools applicable to interferograms are enabled
- Spectra are still calculated in the background but will not be displayed until Spectrum view is selected
- Interferogram view is unavailable when operating in Basic level

To switch between the views, use the quick-switch button found in the Settings bar, or use the short-cut Ctrl+D.

7.1.3. Setting the Unit of the Horizontal Axis

In Interferogram view, the horizontal axis unit is set to optical path difference in mm (or μm when suitable), which cannot be changed.

In Spectrum view, it is possible to change the horizontal axis unit by using the x-axis unit combo box in the settings bar. The available options are:

- Wavenumber (cm^{-1})
- Wavelength (nm) in Air
- Wavelength (nm) in Vacuum
- Frequency (THz)
- Photon Energy (eV)

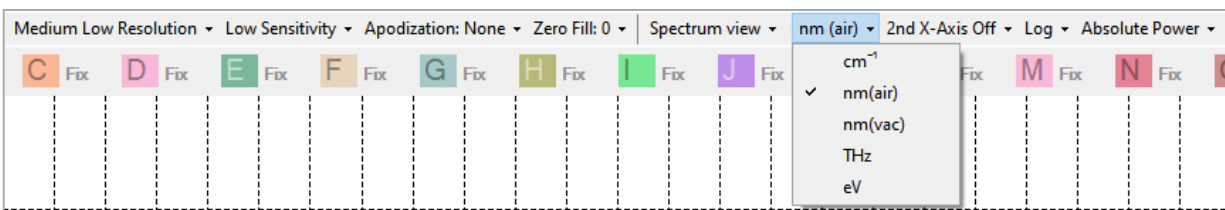

Figure 17. Setting the Horizontal Axis Unit in Spectrum view

7.1.4. Setting the Unit of the Vertical Axis

In Interferogram view, the vertical axis displays the interferogram as a percentage of the full measurable range (default) or in “counts” on the ADC. To switch between the two units, open the Settings dialog, select the Display page, and check or uncheck the box “Interferogram in Percent.”

In Spectrum view, the vertical axis is set by default to show optical power in linear scale in mW, but it can also be set to dBm by selecting “Log” from the vertical axis unit combo box in the settings bar.

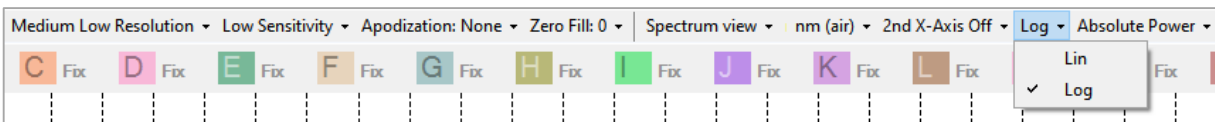

Figure 18. Setting the Vertical Axis Unit

7.1.5. Displaying the Interferogram While Working in Spectrum View

Selecting the option “Interferogram View” in the combo box under the Display menu will show a secondary display area above the main display area. The upper display will show the entire interferogram while the lower will display the spectrum. This can be useful to see that there are no undesired structures in the interferogram causing problems in the spectrum.

This option is only available if an OSA is connected to the computer or at least one spectrum/interferogram from an OSA has been loaded into the software. This option is not available in Basic level.

7.2. Acquiring Data

7.2.1. Acquiring a Single Spectrum/Interferogram

The Redstone OSA305 will acquire one spectrum per detector, which can be shown as a stitched spectrum or separately. Note that the noise floor of the two detectors might not be at the same level, which presents itself as a ramp in the spectrum when there is no light in the overlap region. However, the transition is power calibrated so that the two detector responses match with light input.

7.2.2. Repeated Measurements

The autogain algorithm will continuously investigate the collected interferogram(s) and make slight adjustments to gain and/or offset to ensure best possible settings. Whenever necessary, such as when the input source conditions have changed considerably, the Redstone autogain algorithm will run a series of short sweeps to determine optimal gain and offset settings. An overlay window will appear during this time advising the user to wait for optimization to complete.

7.2.3. Automatic Setup

The automatic setup routine performs a series of measurements on the unknown light source currently being coupled into the OSA and adjusts the measurement settings to those most suitable for that source. The settings that will be adjusted are the resolution (Section 4.8), sensitivity (Section 4.8), apodization (Section 4.10), zero fill factor (Section 4.11), and gain.

The routine is started by clicking on the “Auto Setup” button under the Instrument menu. It can take up to a minute to complete, and no other measurements can be performed while it is running.

7.2.4. Averaging Interferograms (Redstone OSA305 only)

The white broadband reference source in the Redstone OSA305 allows for an exact determination of the ZPD position. This makes it possible to average interferograms, which has the same main effect as averaging spectra.

7.2.5. Signal

Signal analysis inspects the amount of light entering the spectrometer. This window is useful for alignment purposes.

The Signal window displays for each detector, in large type, the percentage of the full range that was used by the last acquired interferogram. This information can be used to determine whether the interferogram is saturated or whether the interferogram contains too little light for the measurement to be useful.

Further information displayed is the interferogram contrast (defined as the difference between the maximum and minimum intensities divided by the doubled average intensity), the most recent gain level used, a control switching between automatic and manual gain modes, the current gain and offset levels, and controls for the attenuation filters (Redstone OSA305 only).

The analysis results are displayed in a floating window or docked below the main display area.

Channel	D1 1000-2600 nm	D2 2000-5600 nm
Signal	32 %	18 %
Interferogram Contrast	57 %	70 %
Last Gain	7	11
Gain Control	Auto	Auto
	7	11
Offset	2184	3765
Filter Control	Auto	Auto
	Off	Off

Figure 19. Signal Window

7.2.6. Measurements of Pulsed Sources

While a Michelson interferometer depends on the input light not changing properties during a measurement, it is possible to measure pulsed sources with a Thorlabs OSA under certain circumstances. The pulses will introduce artifacts – so called spectral ghosts – in the spectrum, but if the repetition rate of the input light is higher than about 7 kHz (Redstone OSA305) or 30 kHz (OSA20xC), the spectral ghosts will be pushed out from the vicinity of the true peak and the spectrum of the pulsed light will be close to that of a corresponding CW light source, even using a normal Single or Repeat measurement.

For those cases, in which the spectral ghosts are interfering with the true spectrum, the Pulsed Source Measurement mode can help improve the result. To start this routine, click the “Pulsed” button located under the Instrument menu, noting that this routine will overwrite the current settings for and data in traces A through D (Redstone OSA305) or through E (OSA20xC).

In order to perform a Pulsed Source Measurement, the software switches to Spectrum view, and sets the number of averaged traces to 1000. The OSA is then cycled through all available sensitivity modes and rolling averages of the spectra in each sensitivity mode are stored in traces A through C or D. The last trace, which represents the final measured spectrum of the pulsed source, is generated by comparing the preceding traces and retaining the minimum measured value in each data point.

The pulsed measurement will run repeatedly until the “Stop” button is clicked. Note that there can be a delay after the “Stop” button is clicked until the measurement is actually stopped.

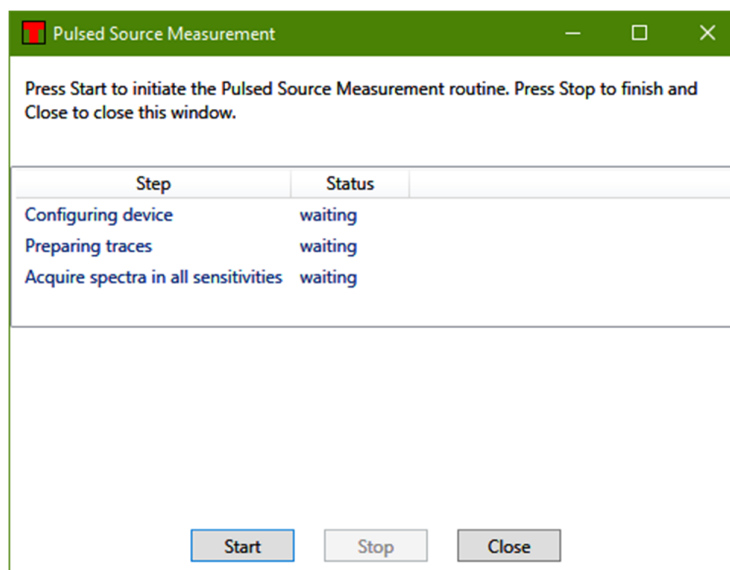

Figure 20. Pulsed Source Measurement Dialog

7.2.7. Wavelength Calibration (Redstone OSA305 only)

The Redstone OSA305 instrument includes an internal reference laser that is used to track the movement of the moving retroreflector. This laser is frequency-locked and can thus serve as a calibration laser with a well-defined wavelength down to 0.1 pm. To use the reference laser to wavelength calibrate the Redstone, click the “Wavelength Calibration” button in the Instrument menu and follow the instructions. A fiber for infrared wavelengths with a FC/APC connector on one side and a FC/PC connector on the other side is required, such as the Thorlabs Item # P5-SMF28E-FC-2; one such fiber is included with the instrument at delivery. The reference laser can be accessed through the FC/APC connector on the front panel under the “Calibration Output” label.

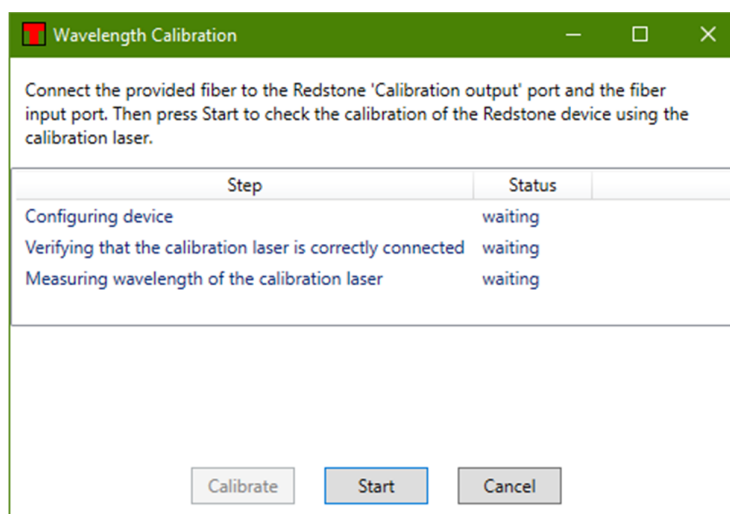

Figure 21. Wavelength Calibration dialog

7.3. Working with Data in Traces

For interferogram-acquiring devices such as OSA20xC and Redstone OSA305, the ThorSpectra software handles not only up to 26 traces labeled from A to Z for spectra but also traces labeled from 1 to 26 for interferograms.

7.3.1. Trace Update Options

The following update options are available for OSA20x and Redstone OSA305:

- **Write:** Traces with this option will be overwritten at the next acquisition. Interferogram traces (1 through 26) will be overwritten with the acquired interferogram, and spectrum traces (A through Z) will be overwritten with the calculated spectrum. Note that interferogram traces with “Write” status will be overwritten even if the software is in Spectrum view, and vice versa. If multiple devices are present, the option exists to specify the device with which to update the data. For devices with multiple detectors, it is also possible to select to view data from one of the detectors or a stitched combination thereof.
- **Fix:** Traces with this option will not be updated at the next acquisition.
- **Average:** Traces with this option will be updated at the next acquisition as a rolling average of the data already existing in the trace and the newly acquired data. It is possible to let the running average stop updating once the desired number of spectra has been collected by selecting the option “Average and Stop.” The Trace Label will show how many spectra have been collected thus far, e.g., “Avg(1 of 5).”
- **Min Hold:** Traces with this option will be updated as the minimum of the currently existing data in the trace and the newly acquired spectrum/interferogram from the selected detector.
- **Max Hold:** Traces with this option will be updated as the maximum of the currently existing data in the trace and the newly acquired spectrum/interferogram from the selected detector.

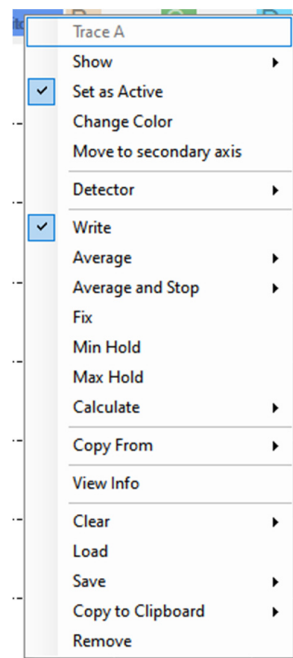

Figure 22. Trace Options Menu

- **Difference:** Traces with this option will be updated as the difference between two other traces *to the left* in the Trace controls bar. The Trace Label will signify how the trace will be calculated, e.g., “B-A” or “A-C.” This trace will be updated when any of the traces involved in its calculation are updated. This option is available under the Calculate sub-menu for traces with at least two traces to the left, e.g., this option is available for traces C and higher.
- **Quotient:** Traces with this option will be updated as the quotient between two other traces *to the left* in the Trace controls bar. The Trace Label will signify how the trace will be calculated, e.g., “B/A” or “A/C.” This trace will be updated when any of the traces involved in its calculation are updated. This option is available under the Calculate sub-menu for traces with at least two traces to the left, e.g., this option is available for traces C and higher.
- **Transmission:** Only available in Spectrum view. Traces with this option will be updated as a quotient between two other traces *to the left* in the Trace controls bar, expressed in percent. The Trace Label will signify how the trace will be calculated, e.g., “Transmission(B, A)” or “Transmission(A, C).” This trace will be updated when any of the traces involved in its calculation are updated. This option is available under the Calculate sub-menu for traces with at least two traces to the left, e.g., this option is available for traces C and higher.
- **Absorbance:** Only available in Spectrum view. Traces with this option will be updated as $-\log_{10}(X/Y)$ where X and Y represent two separate traces *to the left* in the Trace controls bar. The Trace Label will signify how the trace will be calculated, e.g., “Absorbance(B, A)” or “Absorbance(A, C).” This trace will be updated when any of the traces involved in its calculation are updated. This option is available under the Calculate sub-menu for traces with at least two traces to the left, e.g., this option is available for traces C and higher.
- **Derivative:** Traces with this option will be updated as the derivative of another trace *to the left* in the Trace controls bar. The Trace Label will signify in an abbreviated form how the trace will be calculated, (e.g., “Derivative(A, 1)” or “Derivative_FD(C, 3),” where the letters A and C are of which trace the derivative is calculated, the numbers one and three stand for the derivative order, and “Derivative” or “Derivative_FD” signifies the derivative method to use; Savitsky-Golay or Finite difference, respectively. This trace will be updated when the input trace is updated. This option is available under the Calculate sub-menu, for all traces except the left-most, i.e., this option is not available for traces A or 1.

- **Envelope:** Only available in Interferogram view. Traces with this option will be updated as the envelope of the last acquired interferogram from the selected detector. This trace will be updated on each acquisition of an interferogram.

If the calculation of a trace cannot be performed, e.g., if the two input traces have different lengths, the Trace Label background will be red and the reason for the error will be displayed in a popup when hovering over the Trace Label with the mouse pointer.

7.4. Saving and Loading Data

7.4.1. Saving Data

When the “Save All” option has been selected, only traces in the current view (Spectrum view or Interferogram view) will be saved.

7.4.2. Loading Data

If the software is currently running in Spectrum view and the loaded trace is an interferogram, the view will be switched to Interferogram view automatically. Likewise, will a spectrum loaded while in Interferogram view switch to Spectrum view.

7.5. Analyzing Data

Since the OSA20xC and Redstone OSA305 collect interferograms, the two left-most analysis tools are available. The other analysis tools are described in the ThorSpectra User Guide.

7.5.1. Wavelength Meter

The Wavelength Meter analysis tool very accurately determines the wavelength of the input light to the spectrometer. This analysis is only available for light from sources with a bandwidth of 10 GHz or less. This tool works by analyzing the periodicity of the collected interferograms before apodization is performed. The number of cycles in the interferogram are counted and compared to the number of cycles in the interferogram of the built-in reference laser (see Section 4.1 Introduction).

When the Wavelength Meter tool is enabled, the analysis results are displayed in a floating window or docked to the main display area. The calculated wavelength is displayed in the currently set x-axis spectral units. If the input light does not have sufficiently narrow linewidth for the analysis to work properly, the text “Invalid Value” will be displayed instead of a number. The calculated wavelength is displayed with an accuracy that corresponds to the estimated error in the measurement. If the source shows multimode behavior, the number of significant decimals displayed will be reduced to reflect the reduced precision of the measurement. The analysis estimates the error in the measured wavelength, displaying the significant digits in black and the not significant digits in gray. The control “Decimals” in the options panel makes it possible to manually set the number of decimals to display.

The tool window shows the minimum, maximum, mean, and standard deviation of the wavelengths that have been measured while the wavelength meter tool has been active. The values are updated after every new sweep. The statistics can be reset by clicking the “Clear” button.

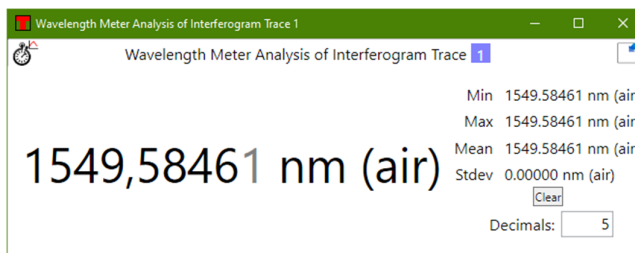

Figure 23. Wavelength Meter Window

Note that the wavelength metering is performed on the interferogram during the collection process prior to apodization and it is not necessary to turn off the apodization for this analysis tool to function.

7.5.2. Coherence Length

Coherence length analysis uses the interferogram to estimate the coherence length of the input. The coherence length measurement looks at the envelope of the interferogram and calculates the coherence length as the shortest optical path length difference over which the envelope amplitude decreases to $1/e$ of its maximum on both sides. If the interferogram is single-sided, the amplitude might not have decreased enough within the data range. In this case, the envelope amplitude on the long side is checked and estimated on the short side.

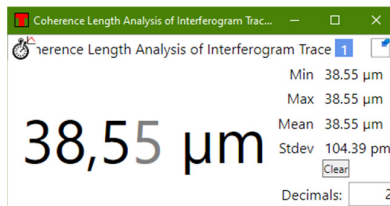

Figure 24. Coherence Length Window

The analysis results are displayed in a floating window or docked below the main display area. If the coherence length of the input source is longer than the optical path length difference obtainable by the instrument in the currently active resolution mode, the calculated value will merely be displayed as larger than the current optical path length difference (e.g., in high resolution mode for an OSA20xC, ">81.67 mm" and the error message "Coherence Length Too Large To Be Measured" will be displayed).

The Coherence Length analysis tool is very sensitive to detector saturation in the interferogram. Whenever a saturated interferogram is analyzed, the analysis result will be displayed in red and the error message "Saturated Interferogram" will be displayed below the analyzed result.

The tool window shows the minimum, maximum, mean, and standard deviation of the coherence lengths that have been measured while the coherence length tool has been active. The values are updated after every new sweep. The statistics can be reset by clicking the "Clear" button.

7.6. Scripting the ThorSpectra Software (OSA20xC only)

The operations found in the Graphical User Interface of the ThorSpectra software can be automated using scripts. Scripts can be run in two ways: either by opening a script in the scripting dialog box, or as a command-line argument to the software at startup. The scripting dialog box is opened by clicking on "Script" in the File menu. ThorSpectra can interpret scripts written in the languages C# and Python.

To create a new script, click "New" in the menu bar of the scripting dialog box and select the language of the script. This will create a new script containing a few lines of code, which must be kept for the ThorSpectra software to be able to interpret and run the script. The scripting dialog consists of two parts. The upper part is a multi-tabbed editor where the scripts can be entered and edited easily. The lower part is an output window where messages from the scripts will be printed.

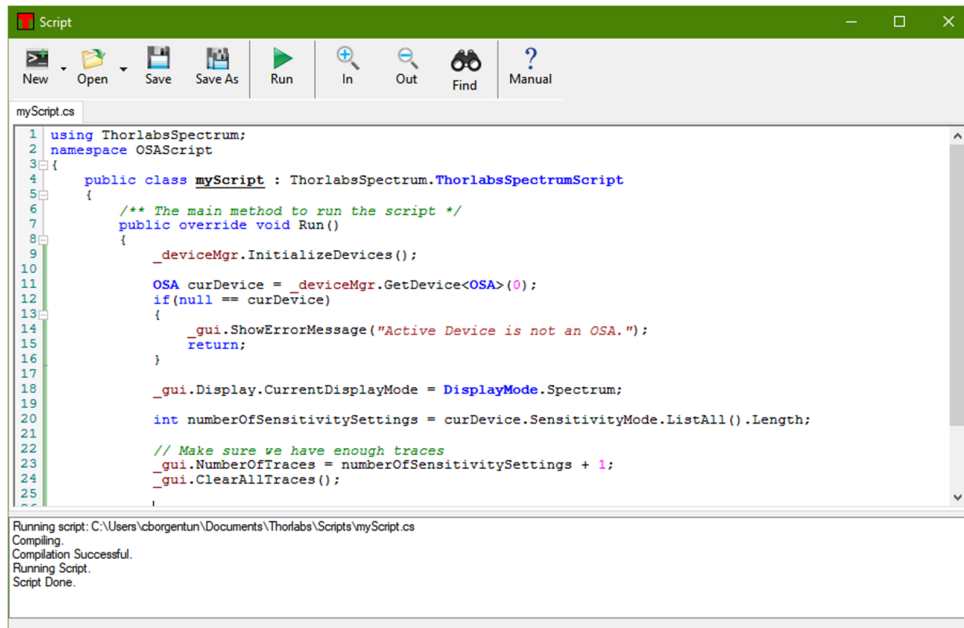

Figure 25. Script Window

For more information on the syntax and commands available to scripts, please see the separate manual “Scripting ThorSpectra” installed with the ThorSpectra software and found in the Windows® Start menu.

Chapter 8 Settings

Pressing the Settings button in the main menu will open the Settings dialog. By default, the Settings dialog box will start in Basic level. To see more advanced settings, press the “Switch to Advanced level” button in the lower left corner of the dialog.

This document will describe the settings found under the Active Device page; the other pages are described in the ThorSpectra User Guide.

8.1. Basic Settings

8.1.1. Active Device Settings

The first page in the Settings dialog allows the user to setup the general properties of the data acquisition. The resolution vs. update frequency slider allows the user to indicate whether to prioritize spectral resolution or high (temporal) update frequency.

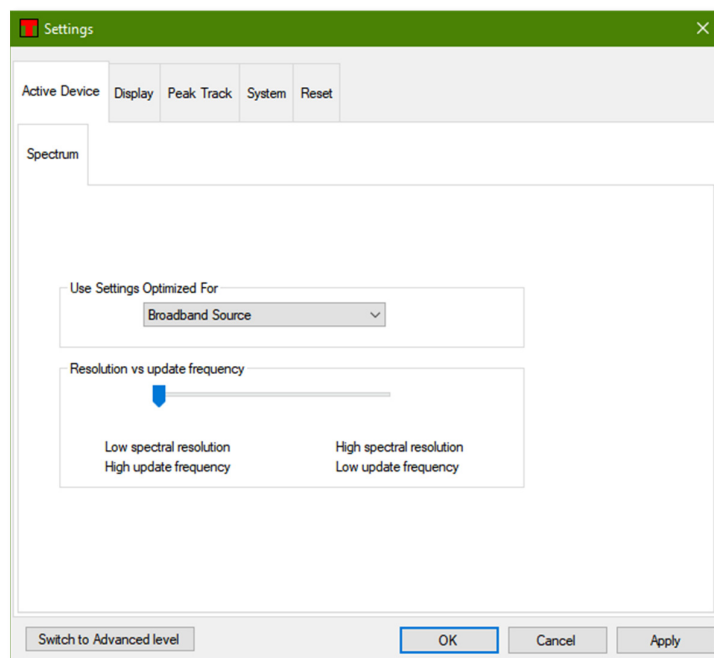

Figure 26. Spectrum Setup Page in Basic Level

8.2. Advanced Settings

When operating in Advanced level, there are four tabs in the Active Device page.

8.2.1. Acquisition Settings

In the Acquisition tab, it is possible to specify the instrument settings.

The Acquisition Interval is the minimum time between two subsequently collected interferograms. Setting this to zero (default) will cause the software to perform the measurements as fast as possible. Setting this to a higher value will induce a pause between each collected interferogram which can be beneficial under some circumstances, such as when collecting a long time series of measurements.

The Resolution can be set to either “High” (higher resolution, slower update rate) or “Low” (lower resolution, faster update rate). For Redstone devices, there are two additional resolution modes to choose from, “Medium High” and “Medium Low.”

The Sensitivity of the Redstone OSA305 can be set to “Low”, “Medium”, or “High.” For OSA20xC devices, there are instead four options: “Low”, “Medium Low”, “Medium High”, and “High.” Using a higher sensitivity setting

allows for higher gain settings, which can result in a higher SNR of the measurement, especially for weak sources, but also a slower update rate.

Note: When changing the Resolution and/or Sensitivity settings, the speed and stroke length of the motor in the instrument will change. Please allow a few seconds for the motor to adjust to the new settings before performing measurements.

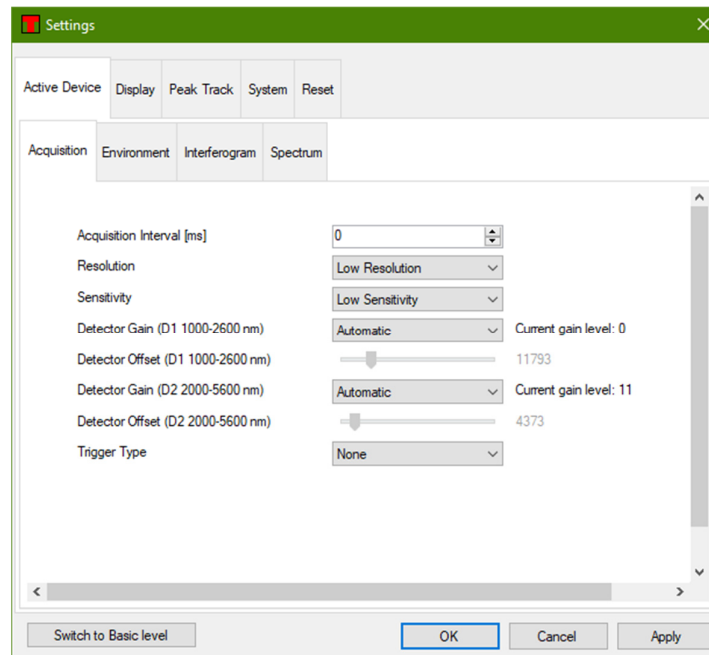

Figure 27. Acquisition Settings Tab

The gain of the detectors can be specified using the combo box(es) on the Acquisition tab. The “Automatic” option automatically adjusts the gain used after each acquired interferogram to optimize the SNR of the acquired spectra. To manually set the gain to use, select the desired gain from the combo box. Note that the used gain will be changed just before acquiring the next interferogram which can take several seconds. The gain can also be set in the Signal window (see Section 7.2.5).

8.2.2. Environment Settings

In the Environment settings tab, it is possible to set whether the temperature, atmospheric pressure, and relative humidity saved in each interferogram and spectrum should be measured using the built-in sensor in the instrument or be set to a fixed value.

8.2.3. Interferogram Settings

In the Interferogram settings tab, it is possible to set the processing that is applied to each collected interferogram.

The type of apodization to apply to each interferogram is set by the “Apodization” combo box. This setting is also available in the Acquisitions settings bar in the main window. The available apodization functions are described in Section 14.2.

In order to eliminate high-frequency spectral components, the interferograms can be cut to a shorter effective length than that determined by the Resolution setting. To do so, check the “Cut interferogram” box and specify the desired maximum optical path difference (in centimeters). The minimum optical path difference will be automatically updated. The resulting resolution (in current x-axis unit) will be shown, under the condition that a suitable resolution setting is selected. Which resolution mode is required is mentioned in a textbox just below the resulting resolution value.

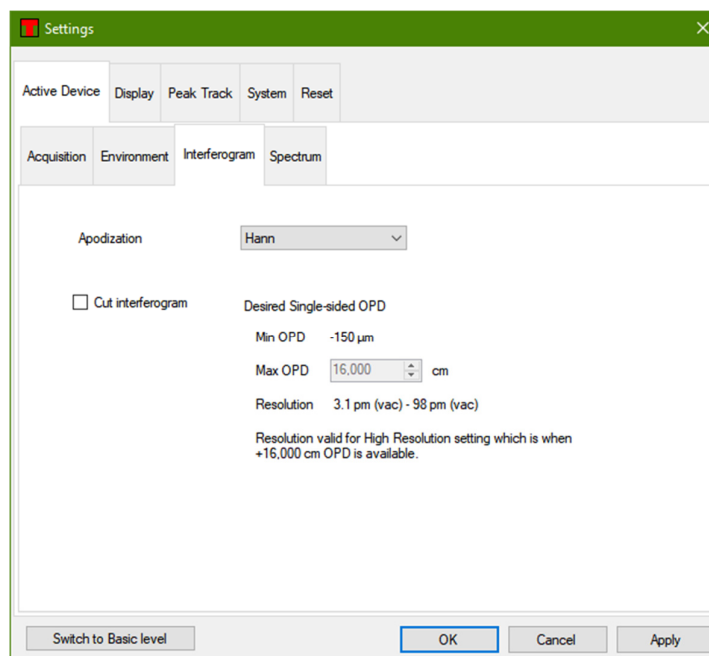

Figure 28. Interferogram Processing Settings

8.2.4. Spectrum Settings

In the Spectrum settings tab, it is possible to specify a large number of settings for the processing of the spectra.

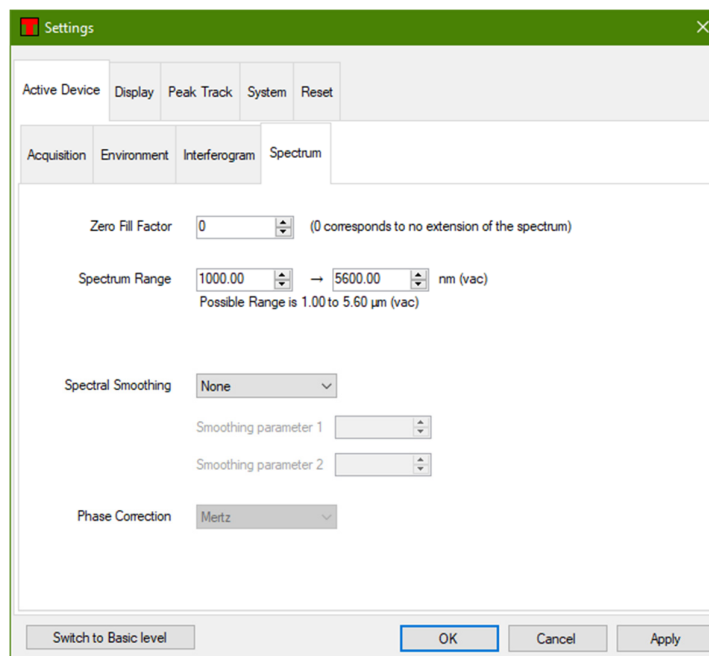

Figure 29. Spectrum Processing Settings

- Zero Fill Factor:** If not zero, the interferograms will be extended with zeros before the Fourier transform is applied. A value of one means that the interferogram will be doubled in length and a value of two means that the interferogram will be quadrupled. This increases the number of data points in the spectrum and increases the apparent resolution of the spectra.

- **Spectrum Range:** If only a sub-section of the available x-axis range is required for the measurement, it can be beneficial to crop the spectrum to the desired range to reduce the amount of data to work with. Note that this cropping is not reversible.
- **Spectral Smoothing:** If the spectra are collected at a much higher resolution than necessary, smoothing can be applied to reduce the noise in the measurement.
- **Phase Correction:** This option is not selectable and is only for information purposes. When the interferogram is transformed into a spectrum, the phase error of the interferogram will be corrected to reduce the error in the measurement. OSA20xC models do not correct for the phase, while Redstone OSA305 performs a Mertz compensation.

Chapter 9 LabVIEW® Drivers

The Redstone OSA305 and OSA20xC instruments can be controlled by custom LabVIEW® programs, if the required drivers have been installed. These can be downloaded from the ThorSpectra software page (https://www.thorlabs.com/software_pages/ViewSoftwarePage.cfm?Code=OSA). Before installing the LabVIEW® driver, please make sure that the ThorSpectra application has been installed.

The LabVIEW® driver contains functions for acquiring, processing, analyzing, and plotting interferograms and spectra with different options. The drivers are based on functions found in the FTSLib.dll which is also used by the application GUI. See Thorlabs → Manual FTSLib in the Windows® Start menu for details.

The drivers can be accessed from the Windows® Start menu under Thorlabs → LabView.

The LabVIEW® drivers support LabVIEW® 2010 and later in 64-bit OS, see the readme.pdf for details.

Open the “Tree VI” to get a categorized overview of the drivers and explore the examples for information on how they can be implemented. The small example shows the basic vis required for instrument communication and for acquiring of interferograms and spectra, and a larger example shows how to implement data processing and analyzing functions. Plotting functions are also included to facilitate presentation of large data sets.

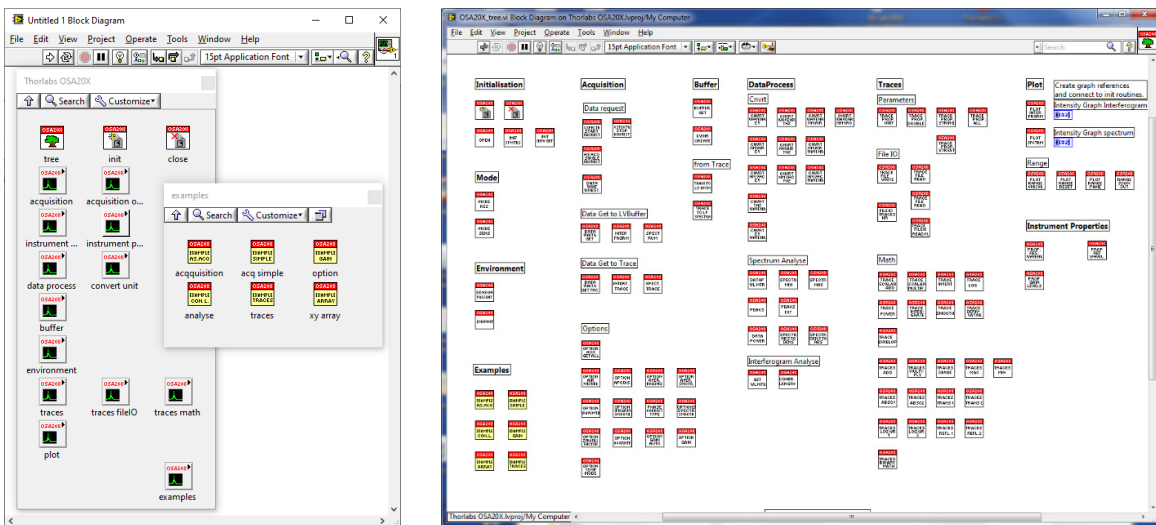

Figure 30. Tree VI Diagram

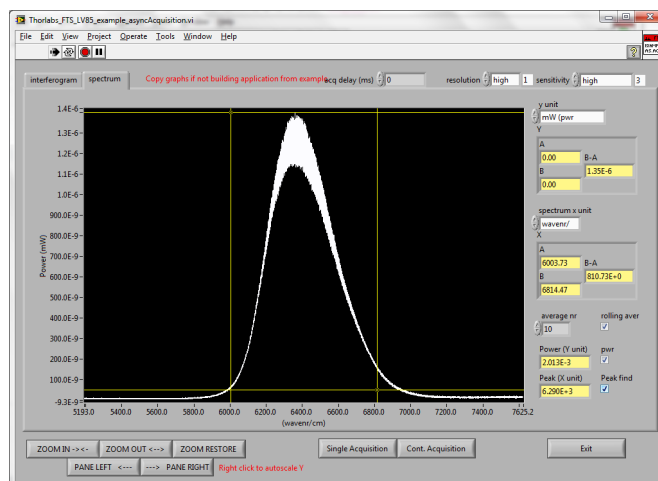



Figure 31. Example LabVIEW® VI

Chapter 10 Troubleshooting

Problem	Action
Software installation failed	Be sure to have administrative rights on your computer which enables you to install the software. Ask your system administrator to give you such rights or to do the installation.
ThorSpectra software cannot find any instrument	<p>If the instrument was connected after the ThorSpectra software was started, it will not automatically detect the instrument. Press the button “Connect Devices” found under Instrument menu to search for connected instruments.</p> <p>Check that Windows® has detected the instrument by opening the “Device manager” found under the Windows® Control panel. The instrument will be presented under the item “Thorlabs devices”, as shown below. Note that it might be necessary to select “Show hidden devices.” If Windows® has not detected the instrument, please make sure that the instrument is turned on and connected to the PC with a USB cable verified for high speed USB 3.0 communication (USB 2.0 for OSA20xC models). If no instrument is found, check the connection of the USB cable or reboot the instrument.</p> 
I have started the measurement but the screen doesn't update	<p>Start by checking your settings;</p> <ul style="list-style-type: none"> • Make sure at least one trace is set to “Write” or “Average”, see Section 7.3.17.3.1 Trace Update Options. • Certain combinations of settings have a very slow update rate, especially High Resolution/High Sensitivity. Please check the green progress bar in the bottom left corner. If the bar is visible, the device is still acquiring or processing data. • Is the acquisition interval set to anything other than zero milliseconds? This setting is found in the Settings dialog under the tab “Acquisition” (you might need to switch to “Advanced level” in the Settings dialog to see this). The acquisition interval is the minimum time between two data acquisitions. • If the interferogram is saturated or non-linear, the data will not be shown and a new acquisition is automatically requested. Open the Signal window from the Instrument menu and make sure that the gain is set to Automatic so that the Autogain algorithm can find optimal settings.
I cannot change the vertical or horizontal axis of the data display	Check if the axis is locked. This is done by clicking on the axis itself. If the check box “Lock axis” is checked, the displayed data range on that axis cannot be changed. This is to prevent accidental dragging or right-clicking in the graph to change the data range displayed. Simply uncheck the “Lock axis” check box and click “Ok.”
If all else fails	Bring up the Error log by simultaneously clicking Ctrl+Shift+E. Save it to file and attach it to an email to techsupport@thorlabs.com .

Chapter 11 Technical data

11.1. Common Specifications

Specification	Value	
	OSA20xC	Redstone OSA305
Spectral Resolution	7.5 GHz (0.25 cm ⁻¹)	1.9 GHz (0.063 cm ⁻¹)
Spectral Accuracy^a	±2 ppm ^b	±0.2 - 1.0 ppm ^b
Spectral Precision^c	1 ppm ^b	1 ppm ^b
Wavelength Meter Resolution^d	0.1 ppm ^b	0.1 ppm ^b
Wavelength Meter Display Resolution^{d,e}	9 decimals	9 decimals
Wavelength Meter Accuracy^{a,d}	±1 ppm ^b	±1 ppm ^b
Wavelength Meter Precision^{d,f}	0.2 ppm ^b	0.2 ppm ^b
Input CW Power (Max)	10 mW (10 dBm)	10 mW (10 dBm)
Input Damage Threshold^g	20 mW (13 dBm)	20 mW (13 dBm)
Power Level Accuracy^h	±1 dB	±0.4 dB
Optical Rejection Ratioⁱ	30 dB	40 dB
Polarization Dependence	±1 dB	±0.1 dB
Input Fiber Compatibility	FC/PC Connectors ^k All Single Mode Patch Cables, Including Fluoride SM Patch Cables Silica Multimode Patch Cables with ≤Ø50 µm Core and NA ≤ 0.22 Fluoride Multimode Patch Cables with ≤Ø100 µm Core and NA ≤ 0.26	
Free-Space Input	Accepts Collimated Beams ≤Ø6 mm Red Alignment Laser Beam Output Four 4-40 Taps for 30 mm Cage Systems	Accepts Collimated Beams ≤Ø10 mm Red Alignment Laser Beam Output Four 4-40 Taps for 60 mm Cage Systems
Dimensions	320 mm x 149 mm x 475 mm (12.6" x 5.9" x 18.7")	541 mm x 224 mm x 533 mm (21.3" x 8.9" x 21.0")

- After a 20-minute warm-up (for OSA20xC), for a single mode FC/PC-terminated patch cable at an operating temperature of 20 °C to 30 °C.
- Specified in parts per million, which corresponds to nearly seven significant figures (depending on the specification). For instance, if the wavelength being measured is 1 µm, the Wavelength Meter Precision will be 200 fm.
- Spectral Precision is the repeatability with which a spectral feature can be measured using the Peak Track tool.
- Measured in Wavelength meter mode (linewidth <10 GHz), see Section 4.6.
- Can be set from 0 - 9 decimals and has an automatic option that estimates the relevant number of decimals.
- Using the same input single mode fiber for all measurements.
- Limited by the damage threshold of the internal components.
- Specified after a 20-minute warm-up (for OSA20xC) using Absolute Power Mode, Zero Fill = 2, and Hann apodization at an operating temperature of 20 °C to 30 °C.
- See Section 4.9.
- Connectors for other fiber input receptacles are available upon request. Contact techsupport@thorlabs.com for details.

Each specification is valid for a single mode FC/PC-terminated patch cable, as well as for a collimated free-space beam with diameter <3 mm and divergence <3 mrad, assuming the included protective window is installed in the free-space aperture.

11.2. Model-Specific Specifications

Item #	Wavelength Range ^a	Level Sensitivity ^b	Free-Space Input Window Material ^c	Operating Temperature
OSA201C	350 - 1100 nm	-50 dBm/nm (350 - 500 nm) -60 dBm/nm (500 - 1100 nm)	Uncoated CaF ₂	10°C to 40°C
OSA202C	600 - 1700 nm	-65 dBm/nm (600 - 700 nm) -70 dBm/nm (700 - 1700 nm)		
OSA203C	1.0 - 2.6 μm ^d (10 000 - 3846 cm ⁻¹)	-70 dBm/nm ^e		
OSA205C	1.0 - 5.6 μm (10 000 - 1786 cm ⁻¹)	-40 dBm/nm	Uncoated ZnSe	10°C to 35°C
OSA207C	1.0 - 12.0 μm (10 000 - 833 cm ⁻¹)	-30 dBm/nm (1.0 - 2.0 μm) -40 dBm/nm (2.0 - 12.0 μm)		
Redstone OSA305	1.0 - 5.6 μm (10 000 - 1786 cm ⁻¹)	-65 dBm/nm (1.0 - 1.5 μm) -70 dBm/nm (1.5 - 5.6 μm)	Uncoated CaF ₂	10°C to 40°C

- a. Limited by the bandwidth of the detectors and the optics.
b. Minimum detectable power per nanometer using Zero Fill = 0 and the highest resolution and sensitivity settings.
c. The window is removable: SM05 thread for OSA20xC and SM18 thread for Redstone OSA305.
d. Specified in high-temperature mode. In low-temperature mode, the wavelength range is 1.0 - 2.5 μm.
e. Specified in low-temperature mode over 1.0 - 2.5 μm. In high-temperature mode, the level sensitivity is -65 dBm/nm over 1.0 - 2.6 μm.

11.3. Update Frequency

11.3.1. OSA20xC

Time Between Updates (Update Frequency)		
Sensitivity	Resolution	
	Low	High
Low	0.5 s (1.9 Hz)	1.8 s (0.6 Hz)
Medium Low	0.8 s (1.2 Hz)	2.9 s (0.3 Hz)
Medium High	1.5 s (0.7 Hz)	5.2 s (0.2 Hz)
High	2.7 s (0.4 Hz)	9.5 s (0.1 Hz)

11.3.2. Redstone OSA305

Time Between Updates (Update Frequency)				
Sensitivity	Resolution			
	Low	Medium Low	Medium High	High
Low	1.6 s (0.64 Hz)	2.0 s (0.51 Hz)	3.7 s (0.27 Hz)	9.5 s (0.11 Hz)
Medium	3.1 s (0.32 Hz)	4.1 s (0.24 Hz)	8.6 s (0.12 Hz)	23 s (0.04 Hz)
High	7.8 s (0.13 Hz)	10 s (0.10 Hz)	22 s (0.05 Hz)	63 s (0.02 Hz)

11.4. Absolute Maximum Ratings

Specification	Value
Input Voltage ^a	100 - 240 VAC, 47 - 63 Hz, 250 W (Max)
Relative Humidity	<80%, Non-Condensing
Storage Temperature	-10 °C to 60 °C
Optical CW Power (Max) ^b	20 mW (13 dBm)

- a. The OSA and the Windows® laptop each come with a region-specific power cord.
b. Limited by the damage threshold of the internal components.

11.5. Trigger Specifications (Redstone OSA305 only)

Contact	Specifications
Trigg, AUX In	Schmitt Trigger Input with 10 kOhm Pull-Up Resistor to +5 V Positive-Going Threshold Voltage, Min: 1.3 V Max: 2.5 V Negative-Going Threshold Voltage, Min: 0.6 V Max: 1.8 V Hysteresis Voltage, Min: 0.4 V Max: 1.5 V Maximum Input Voltage: +5.5 V
Acquiring Data, AUX Out	LOW-Level Output Voltage Max 0.1 V ($I \leq 100 \mu\text{A}$) HIGH-Level Output Voltage Min 4.7 V ($I \leq 100 \mu\text{A}$)

11.6. Interlock Specifications (Redstone OSA305 only)

Interlock Specifications	
Interlock Switch Requirements	Must be Normally Open Dry Contacts, Apply No External Voltages to the Interlock Input
Type of Mating Connector	2.5 mm Mono Phono Jack
Open Circuit Voltage	5 VDC
Short Circuit Current (Typical)	0.5 mA

11.7. Internal Sources Specifications

Source Type	OSA20xC	Redstone OSA305	
	Frequency-Stabilized Laser	Alignment Laser	Frequency-Locked Laser
Usage	Alignment and Reference	Alignment	Reference
Wavelength	633 nm	636 nm	1.53 μm
Maximum Output Power	< 80 μW	< 100 μW	< 10 mW
Beam Divergence	~ 0.2 rad	~ 0.2 rad	~ 0.2 rad

Chapter 12 Mechanical Drawings

12.1. Redstone OSA305

12.1.1. Dimensions

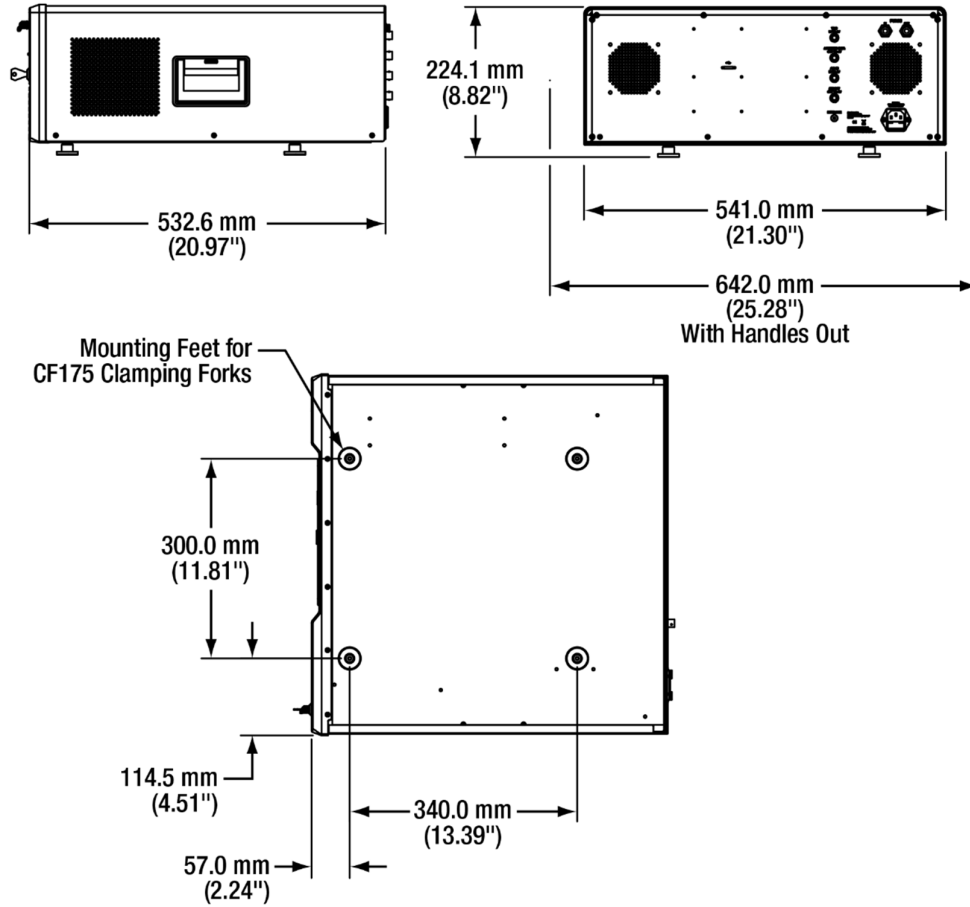

12.1.2. Front and Back Panels

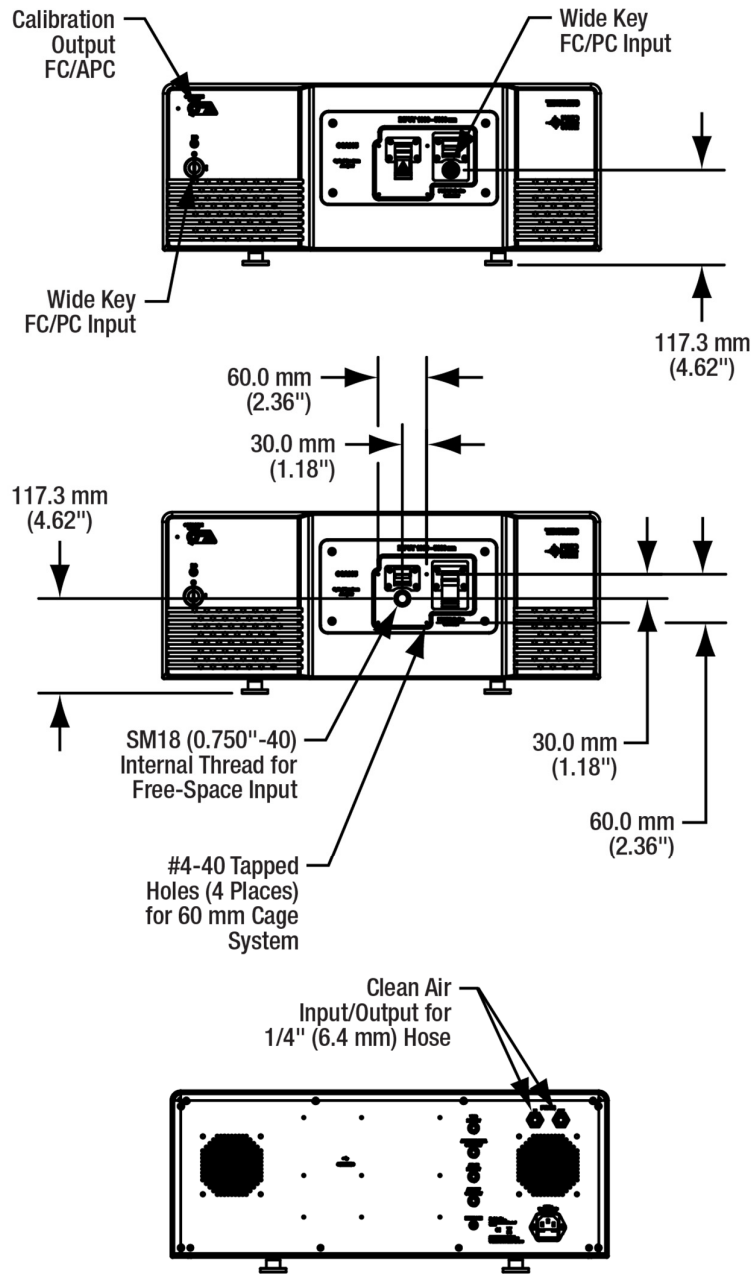

12.2. OSA20xC

12.2.1. Dimensions

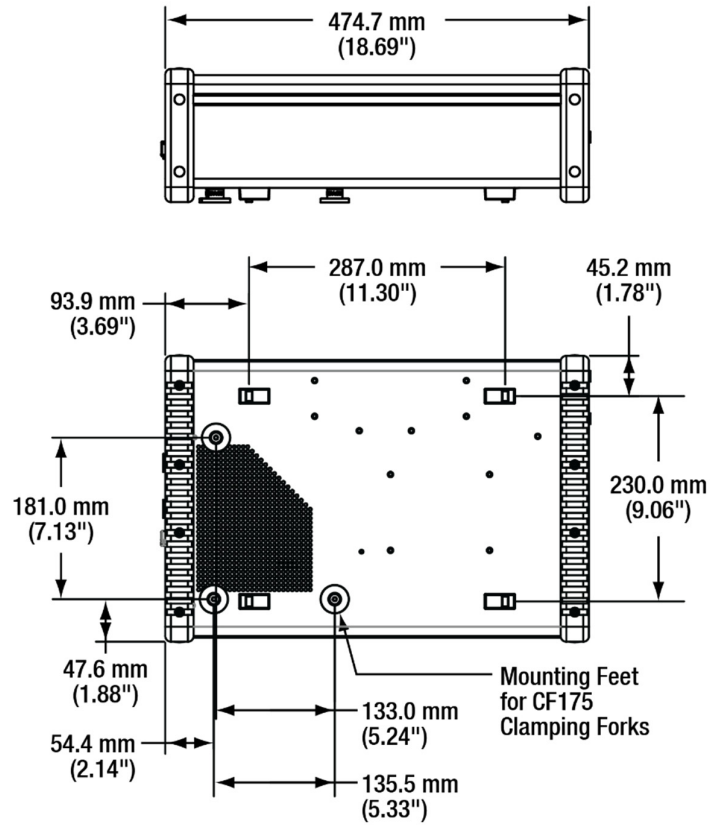

12.2.2. Front and Back Panels

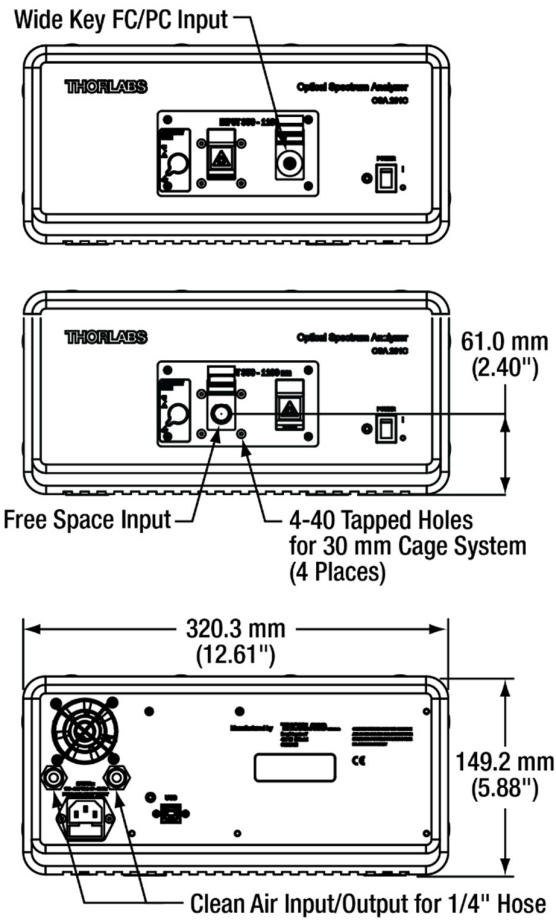

Chapter 13 Certifications and compliances

13.1. Redstone OSA305

Redstone OSA305 has been tested and found complying with the limits according to IEC 61326-1.

Category	Standards or Description
EN 55016-2-1	Conducted Emission, Power Lead
EN 55016-2-3	Radiated Emission
EN 61000-3-2	Harmonics
EN 61000-3-3	Flicker
EN 61000-4-2	Immunity to ESD
EN 61000-4-3	Immunity to RF-Field
EN 61000-4-4	Immunity to Burst
EN 61000-4-5	Immunity to Surge
EN 61000-4-6	Immunity to RF – Common Mode
EN 61000-4-8	Immunity to 50 Hz Magnetic Field
EN 61000-4-11	Immunity to Voltage Variation

Permissible loss of performance during tests: ORR 30dB.

Do not use cellular phones or other radio transmitters close to the instrument as it can degrade performance.

Only use the supplied USB cable or a replacement approved by Thorlabs.

Any cable connected to the interlock must be shorter than 10 m; all other cables shorter than 3 m.

Fans and ventilation holes must not be covered.

If the system requires cleaning, wipe with a dry cloth. Do not use solvents (e.g. ethanol, etc.).

FCC Compliance Statement

Redstone OSA305 has been tested and found to comply with the limits for a Class B digital device, pursuant to part 15 of the FCC Rules. These limits are designed to provide reasonable protection against harmful interference in a residential installation. This equipment generates, uses and can radiate radio frequency energy and, if not installed and used in accordance with the instructions, may cause harmful interference to radio communications. However, there is no guarantee that interference will not occur in a particular installation.

Thorlabs is not responsible for any radio television interference caused by modifications of this equipment or the substitution or attachment of connecting cables and equipment other than those specified by Thorlabs. The correction of interference caused by such unauthorized modification, substitution or attachment will be the responsibility of the user. The use of shielded I/O cables is required when connecting this equipment to any and all optional peripheral or host devices. Failure to do so may violate FCC and ICES rules.

13.2. OSA20xC

Category	Standards or Description
EN 61326-1:2006	Electrical Equipment for Measurement, Control and Laboratory Use – EMC Requirements
EN55011, Group 1, Class B	Emission
EN55011, Group 1, Class B	Conducted Emission
EN 61000-3-2	AC Power Line Harmonic Emissions
EN 61000-3-3	Voltage Fluctuation and Flickers
EN 61000-4-2	Electrostatic Discharge Immunity (Criterion C)
EN 61000-4-3	Electromagnetic field immunity (Criterion A)
EN 61000-4-4	Electrical Fast Transient / Burst Immunity (Criterion B)
EN 61000-4-5	Power Line Surge Immunity (Criterion B)
EN 61000-4-6	Conducted RF Immunity (Criterion B)
EN 61000-4-8	Magnetic field immunity (Criterion A)
EN 61000-4-11	Voltage Dips, Short Interruptions and Voltage Variations Immunity (Criterion C)

Chapter 14 Appendix

14.1. Calculating Absorption Cross Sections

The ThorSpectra software calculates absorption cross sections from the HITRAN line-by-line references by separating each line into a *line strength* and a *line shape*:

$$\sigma(\nu) = S_{\eta\eta}(T) \times g(\nu - \nu_{\eta\eta} - \delta)$$

Here, $S_{\eta\eta}(T)$ is the temperature-dependent strength of the line, g is a function describing the shape of the line, $\nu_{\eta\eta}$ is the center wavenumber of the line, and δ is the shift in pressure.

The line strength, $S_{\eta\eta}(T)$, is dependent on temperature because the temperature determines how strongly the upper and lower energy levels are populated.

$$S_{\eta\eta}(T) = S_{\eta\eta} \times \exp\left(-\frac{hc}{k_B} E_{\eta} \left(\frac{1}{T} - \frac{1}{T_0}\right)\right) \times \left(\frac{T_0}{T}\right)^m \times \frac{1 - \exp\left(-\frac{hc\nu_{\eta\eta}}{T}\right)}{1 - \exp\left(-\frac{hc\nu_{\eta\eta}}{T_0}\right)}$$

Here, E_{η} is the energy of the lower energy level, m represents the temperature dependence of the partition function, T is the given temperature and T_0 is the reference temperature.

The line shape is affected by two effects: Doppler broadening – caused by random molecular motion – and pressure broadening – caused by collisions between molecules. Doppler broadening leads to a Gaussian line shape with half-width at half-max given by:

$$\alpha_G = \frac{\nu_{\eta\eta}}{c} \sqrt{\frac{2k_B T}{m}}$$

where m is the molecular mass. In contrast, pressure broadening leads to a Lorentzian line shape with half-width at half-max given by:

$$\alpha_L = \left(\frac{T_0}{T}\right)^n \times \frac{P}{P_0} \times (\gamma_{air} \times (1 - q) + \gamma_{self} \times q)$$

where γ_{air} is the broadening caused by collisions with other species, γ_{self} is the broadening caused by molecules of the same species, and q is the mixing ratio of the gas. The exponent n is transition-dependent and given by the line-by-line reference.

The combination of Doppler broadening and pressure broadening can be calculated by a convolution between the Gaussian and Lorentzian line shapes, and produces a profile known as the Voigt line shape.

In many cases, pressure broadening has a significantly greater effect than Doppler broadening. If the half-width at half-max of the Gaussian line shape is less than 1% of the half-width at half-max of the Lorentzian line shape, the software approximates the line shape by using only the Lorentzian. Otherwise, the full convolution is calculated.

14.2. Apodization Functions

The following apodization functions are implemented in the ThorSpectra software:

Norton-Beer (Weak)	$F(x_{norm}) = 0.384093 - 0.087577(1 - x_{norm}^2) + 0.703484(1 - x_{norm}^2)^2$
Norton-Beer (Medium)	$F(x_{norm}) = 0.152442 - 0.136176(1 - x_{norm}^2) + 0.983734(1 - x_{norm}^2)^2$
Norton-Beer (Strong)	$F(x_{norm}) = 0.045335 + 0.554883(1 - x_{norm}^2)^2 + 0.399782(1 - x_{norm}^2)^4$
Triangular	$F(x_{norm}) = 1 - abs(x_{norm})$
Cosine	$F(n) = \sin\left(\frac{\pi n}{L-1}\right)$
Hann	$F(n) = \frac{1}{2}\left(1 - \cos\left(\frac{2\pi n}{L-1}\right)\right)$
2-Pass Hann	$F(n) = \frac{1}{4}\left(1 - \cos\left(\frac{2\pi n}{L-1}\right)\right)^2$
Hamming	$F(n) = 0.54 - 0.46 \cos\left(\frac{2\pi n}{L-1}\right)$
3-Term Blackman-Harris	$F(n) = 0.4243801 - 0.4973406 \cos\left(\frac{2\pi n}{L-1}\right) + 0.0782793 \cos\left(\frac{4\pi n}{L-1}\right)$
4-Term Blackman-Harris	$F(n) = 0.35875 - 0.48829 \cos\left(\frac{2\pi n}{L-1}\right) + 0.14128 \cos\left(\frac{4\pi n}{L-1}\right) - 0.01168 \cos\left(\frac{6\pi n}{L-1}\right)$
Gaussian	$F(x_{norm}) = \exp\left(-\frac{x_{norm}^2}{2 \times 0.4^2}\right)$

In these functions, L denotes the length of the interferogram, n is the index count (from 0 to $L - 1$), and $x_{norm} = \left(\frac{2n}{L-1} - 1\right)$.

Chapter 15 Regulatory

As required by the WEEE (Waste Electrical and Electronic Equipment) Directive of the European Community and the corresponding national laws, Thorlabs offers all end users in the EC the possibility to return “end of life” units without incurring disposal charges.

This offer is valid for Thorlabs electrical and electronic equipment:

- Sold after August 13, 2005
- Marked correspondingly with the crossed out “wheelie bin” logo (see right)
- Sold to a company or institute within the EC
- Currently owned by a company or institute within the EC
- Still complete, not disassembled and not contaminated

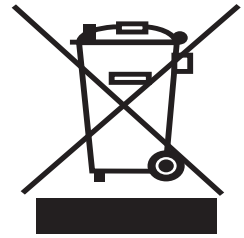

Wheelie Bin Logo

As the WEEE directive applies to self-contained operational electrical and electronic products, this “end of life” take-back service does not refer to other Thorlabs products, such as:

- Pure OEM products, that means assemblies to be built into a unit by the user (e. g. OEM laser driver cards)
- Components
- Mechanics and optics
- Left over parts of units disassembled by the user (PCB's, housings etc.).

If you wish to return a Thorlabs unit for waste recovery, please contact Thorlabs or your nearest dealer for further information.

15.1. Waste treatment is your own responsibility

If you do not return an “end of life” unit to Thorlabs, you must hand it to a company specialized in waste recovery. Do not dispose of the unit in a litter bin or at a public waste disposal site.

15.2. Ecological background

It is well known that WEEE pollutes the environment by releasing toxic products during decomposition. The aim of the European RoHS directive is to reduce the content of toxic substances in electronic products in the future.

The intent of the WEEE Directive is to enforce the recycling of WEEE. A controlled recycling of “end of life” products will thereby avoid negative impacts on the environment.

Chapter 16 Thorlabs Worldwide Contacts

For technical support or sales inquiries, please visit us at www.thorlabs.com/contact for our most up-to-date contact information.



USA, Canada, and South America

Thorlabs, Inc.
sales@thorlabs.com
techsupport@thorlabs.com

Europe

Thorlabs GmbH
europe@thorlabs.com

France

Thorlabs SAS
sales.fr@thorlabs.com

Japan

Thorlabs Japan, Inc.
sales@thorlabs.jp

UK and Ireland

Thorlabs Ltd.
sales.uk@thorlabs.com
techsupport.uk@thorlabs.com

Scandinavia

Thorlabs Sweden AB
scandinavia@thorlabs.com

Brazil

Thorlabs Vendas de Fotônicos Ltda.
brasil@thorlabs.com

China

Thorlabs China
chinasales@thorlabs.com



THORLABS
www.thorlabs.com
