

NOTES:

1. SUBSTRATE: N-BK7
2. S2 TO BE PARALLEL WITH S1 TO < 1 ARCMIN
3. COATING (APPLY ACROSS CLEAR APERTURE)  
S1 & S2: R(AVG) <0.5% @ 350 - 700nm

4. FINE GRIND SURFACE

5. RoHS COMPLIANT

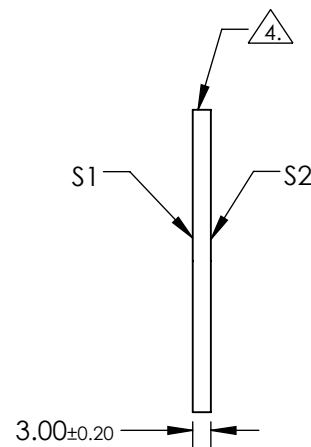
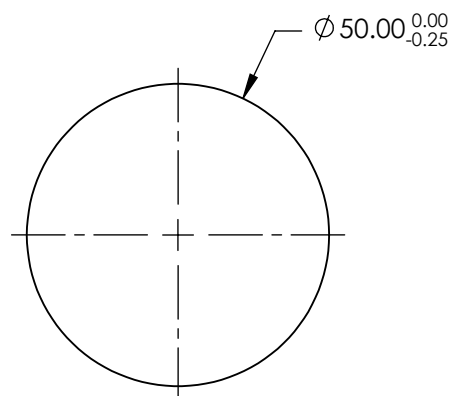
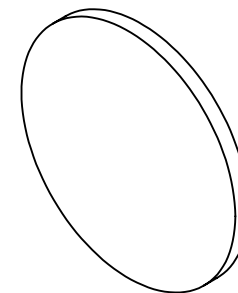

**FOR INFORMATION ONLY:  
DO NOT MANUFACTURE  
PARTS TO THIS DRAWING**

SPECIFICATIONS SUBJECT TO CHANGE WITHOUT NOTICE  
DIMENSIONS ARE FOR REFERENCE ONLY

	S1	S2
SHAPE	PLANO	PLANO
SURFACE QUALITY	60-40	60-40
CLEAR APERTURE	Ø45.00	Ø45.00
BEVEL	PROTECTIVE AS NEEDED	PROTECTIVE AS NEEDED



ALL DIMS IN mm

**EO**® Edmund Optics®

TITLE 50mm DIA., 3mm THICK, VIS-EXT COATED, λ/4 N-BK7 WINDOW

DWG NO 13304

SHEET 1 OF 1