

NOTES:

1. SUBSTRATE: Fused Silica (Corning 7980)
2. ROHS: COMPLIANT
3. SURFACE S2 TO BE PARALLEL TO SURFACE S1 WITHIN <5 ARCMIN
4. COATING(APPLY ACROSS CLEAR APERTURE)

S1 & S2: R(ABS) ≤1.0% @ 250 - 425nm
 R(AVG) ≤0.75% @ 250 - 425nm
 R(AVG) ≤0.5% @ 370 - 420nm

5. TRANSMITTED WAVEFRONT DISTORTION: ≤ 1λ

 FINE GRIND SURFACE

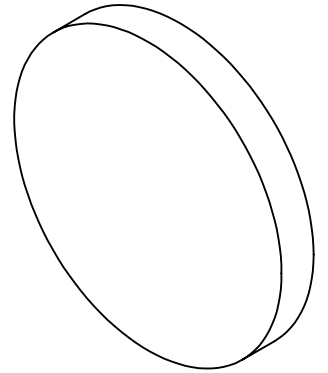
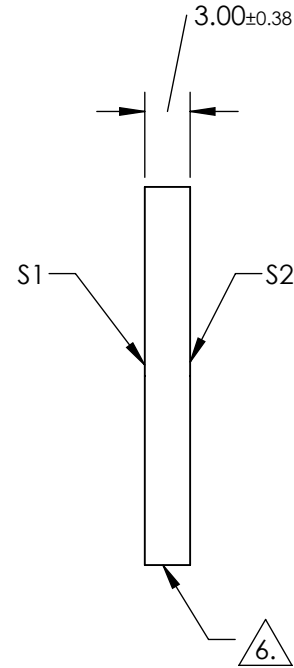
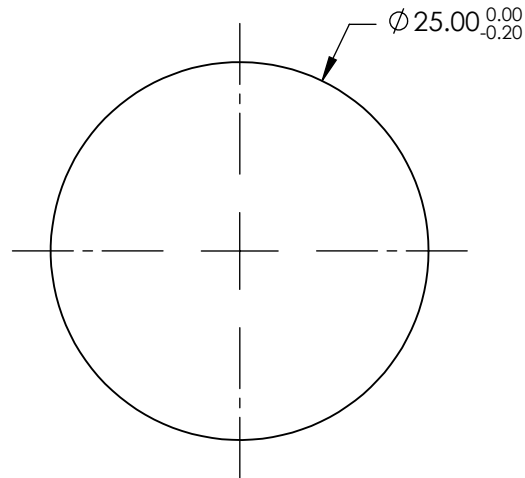

**FOR INFORMATION ONLY:
 DO NOT MANUFACTURE
 PARTS TO THIS DRAWING**

SPECIFICATIONS SUBJECT TO CHANGE WITHOUT NOTICE
 DIMENSIONS ARE FOR REFERENCE ONLY

	S1	S2
SHAPE	PLANO	PLANO
SURFACE QUALITY	60-40	60-40
CLEAR APERTURE	Ø 22.50	Ø 22.50
BEVEL	PROTECTED AS NEEDED	PROTECTED AS NEEDED

THIRD ANGLE PROJECTION 

ALL DIMS IN mm

 **Edmund Optics®**

TITLE

25mm Dia., 3mm Thick UV-AR Coated, 1λ
 Fused Silica Window

DWG NO

19853

SHEET
 1 OF 1