

NOTES:

1. SUBSTRATE MATERIAL:  
N-BK7

2. SURFACE S2 TO BE PARALLEL WITH SURFACE S1 TO WITHIN  $\leq 3$ ARCMIN

3. COATING (APPLY ACROSS CLEAR APERTURE)

S1: 40% R  $\pm 5\%$  @ 550nm  
60% T  $\pm 5\%$  @ 550nm

S2: AR R(avg)  $\leq 1\%$ , R(abs)  $\leq 2\%$  @ 400 - 700nm

4.  CUT WITH 0.25mm MAXIMUM EDGE CHIP

5. ROHS COMPLIANT

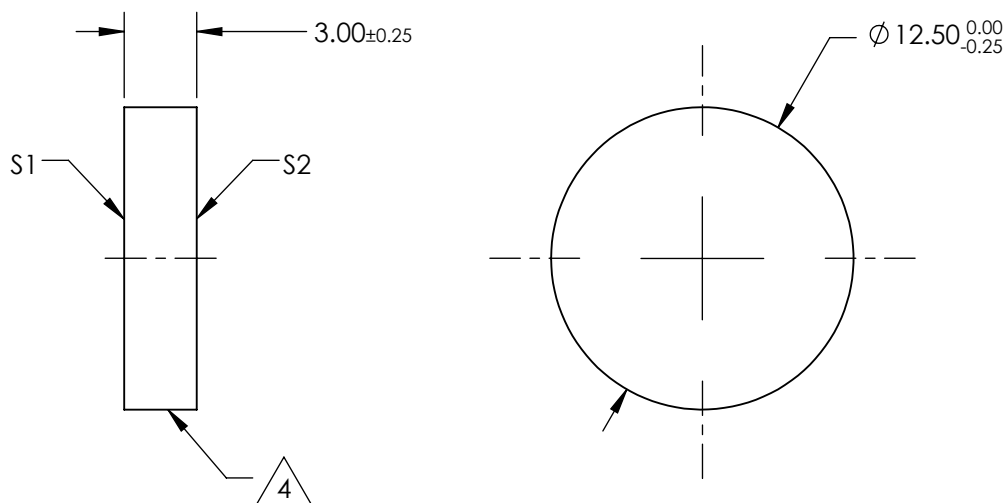

**FOR INFORMATION ONLY:  
DO NOT MANUFACTURE  
PARTS TO THIS DRAWING**

SPECIFICATIONS SUBJECT TO CHANGE WITHOUT NOTICE  
DIMENSIONS ARE FOR REFERENCE ONLY

	S1	S2
SHAPE	PLANO	PLANO
ANGLE OF INCIDENCE	45°	45°
SURFACE QUALITY	60-40	60-40
SURFACE FLATNESS	1λ PER 25mm	1λ PER 25mm

THIRD ANGLE PROJECTION 

ALL DIMS IN mm

 **Edmund Optics®**

TITLE

Ø12.5mm, 40 R/60 T, PLATE BEAMSPLITTER

DWG NO

68381

SHEET  
1 OF 1