

NOTES:

1. SUBSTRATE: UV GRADE FUSED SILICA
2. COATING (APPLY ACROSS COATING APERTURE)  
S1 & S2: RAVG ≤0.5% @ 600 - 1050nm
3. SURFACE S2 TO BE PARALLEL TO SURFACE S1 WITHIN <5 ARCSEC
4. FINE GRIND SURFACE
5. RoHS COMPLIANT

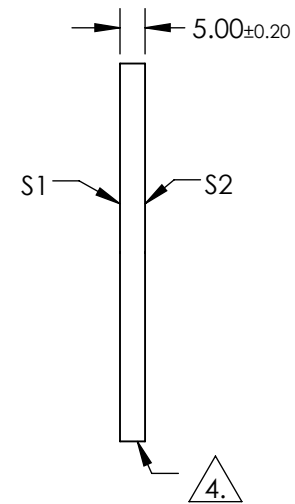
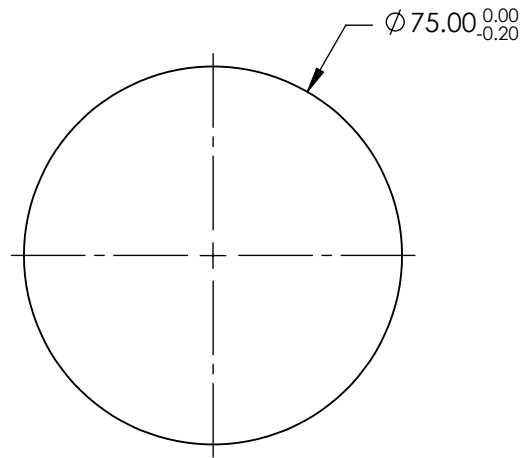

**FOR INFORMATION ONLY:  
DO NOT MANUFACTURE  
PARTS TO THIS DRAWING**

SPECIFICATIONS SUBJECT TO CHANGE WITHOUT NOTICE  
DIMENSIONS ARE FOR REFERENCE ONLY

	S1	S2
SHAPE	PLANO	PLANO
SURFACE QUALITY	20-10	20-10
CLEAR APERTURE	Ø60.00	Ø60.00
BEVEL	PROTECTIVE AS NEEDED	PROTECTIVE AS NEEDED



ALL DIMS IN mm

**EO**® **Edmund Optics**®

TITLE

75mm DIA., 5mm THICK, NIR I COATED λ/10  
FUSED SILICA WINDOW

DWG NO

36962

SHEET  
1 OF 1