

ADAPTER PLATE MOUNTING POSITIONS

POSITION A

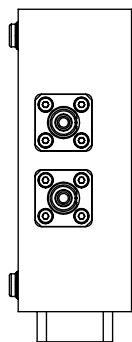

POSITION B

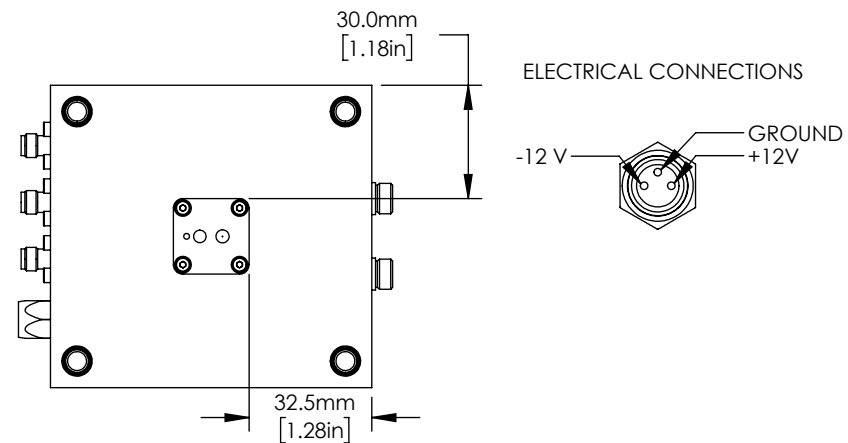
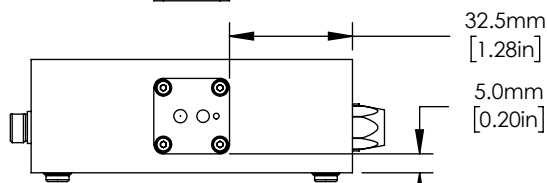
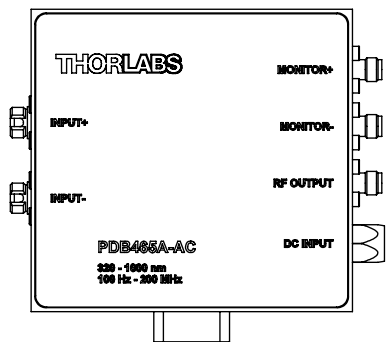
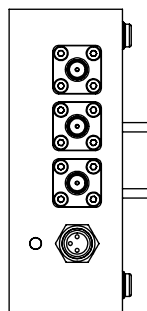

FOR INFORMATION ONLY
NOT FOR MANUFACTURING PURPOSES

DRAWING PROJECTION			 www.thorlabs.com	
NAME	DATE	BALANCED PHOTODETECTOR BANDWIDTH 100 Hz - 200 MHz		
DRAWN	AR	21/SEP/16	MATERIAL	
APPROVAL	VM	30/SEP/16	N/A	
COPYRIGHT © 2016 BY THORLABS			ITEM #	APPROX WEIGHT
VALUES IN PARENTHESIS ARE CALCULATED AND MAY CONTAIN ROUND OFF ERRORS			PDB465A-AC	0.3 kg
			REV	A