

NOTES:

1. SUBSTRATE: ZnSe
2. SURFACE S2 TO BE PARALLEL TO SURFACE S1 TO WITHIN < 3 ARCMIN
3. COATING (APPLY ACROSS COATING APERTURE)

S1 & S2: HIGH- EFFICIENCY BROADBAND (BBAR)
 R(AVG) ≤ 3.0% FROM 3 - 12μm

4. FINE GRIND SURFACE

5. RoHS: COMPLIANT

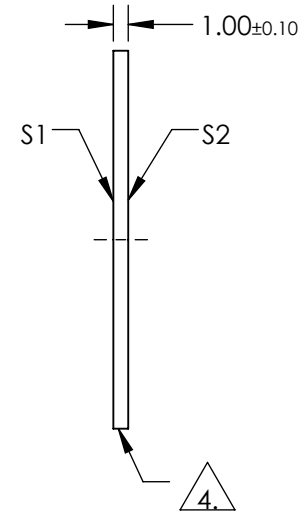
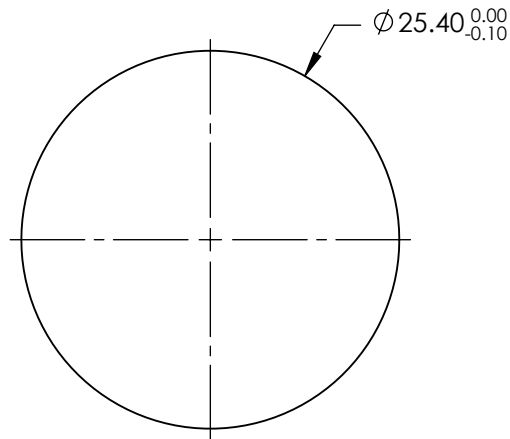
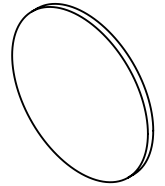

**FOR INFORMATION ONLY:
 DO NOT MANUFACTURE
 PARTS TO THIS DRAWING**

SPECIFICATIONS SUBJECT TO CHANGE WITHOUT NOTICE
 DIMENSIONS ARE FOR REFERENCE ONLY

	S1	S2
SHAPE	PLANO	PLANO
SURFACE QUALITY	40-20	40-20
SURFACE FLATNESS @ 10.6μm	λ/20	λ/20
CLEAR APERTURE	Ø22.86	Ø22.86
BEVEL	PROTECTIVE AS NEEDED	PROTECTIVE AS NEEDED

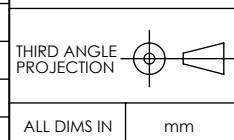

EO® Edmund Optics®

TITLE	25.4mm DIA x 1mm THICK 3 - 12μm COATED ZnSe WINDOW	
DWG NO	39408	SHEET 1 OF 1